

Ø10mm

60 LO-2100

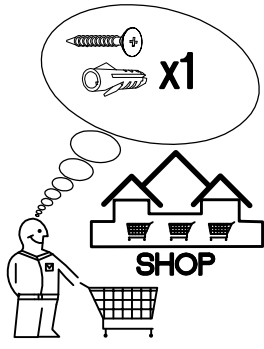
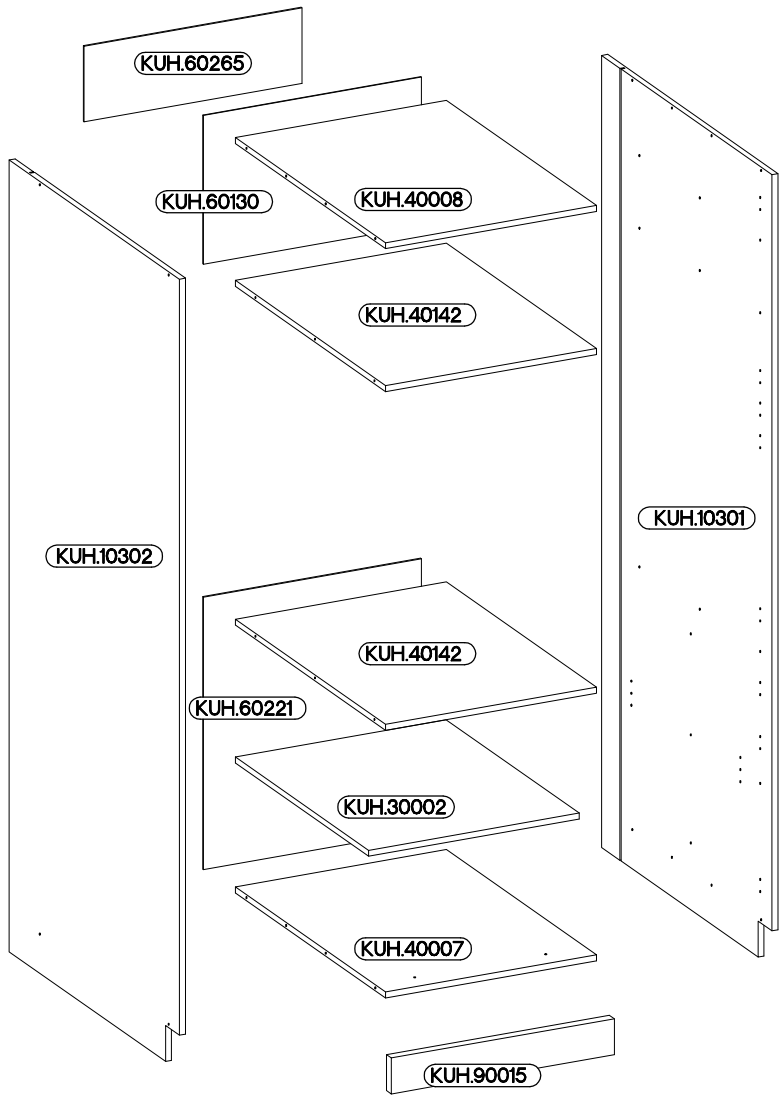
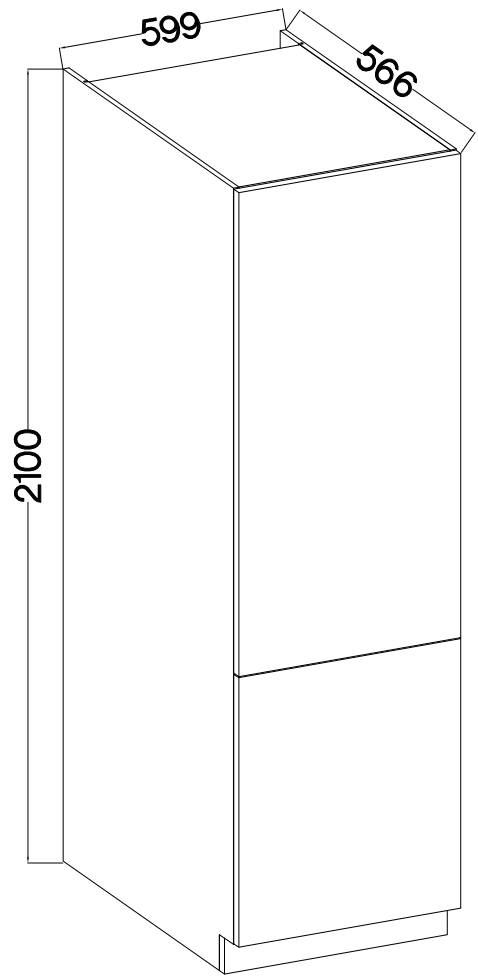
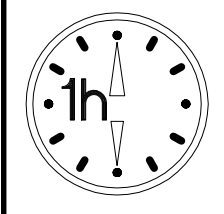
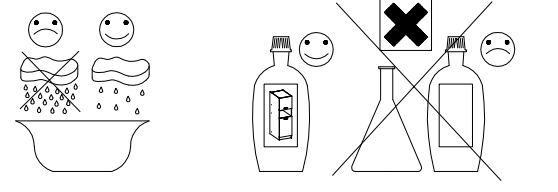

$\dagger 8 \times 30 \text{mm}$	$6,4 \times 50 \text{mm}$	$\dagger 15/12 \text{mm}$
A	B	C
8	8	12

L=20mm				6.5x48x16	$\dagger 35/0 \text{mm}$	$\dagger 5/19 \text{mm}$
D2	E	E1	E9	F2	HG	J
12	12	8	2	4	5	4
		$\dagger 4.0 \times 16 \text{mm}$	$\dagger 4.0 \times 45 \text{mm}$	$\dagger 3.5 \times 13 \text{mm}$	$\dagger 3.0 \times 20 \text{mm}$	
L25	O	P1	P4	P5	P7	T4
1	1	16	2	12	15-20	4

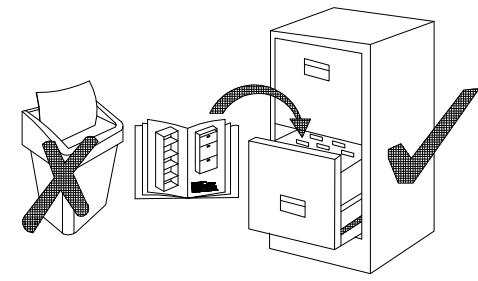

ISM-KUH-01148

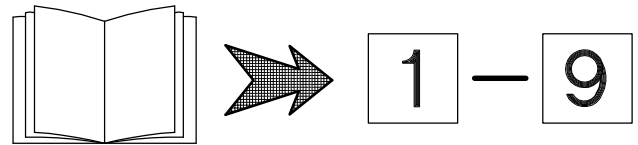
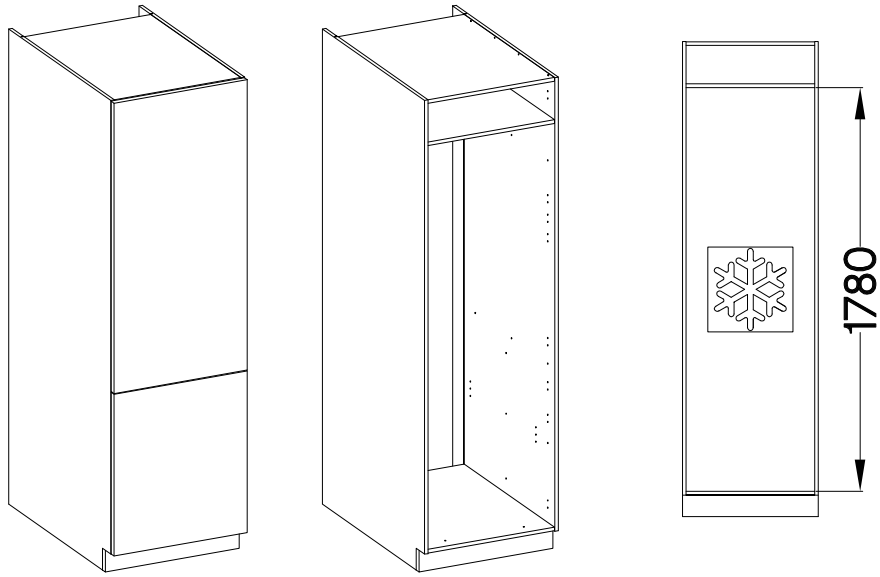

WARIANT B

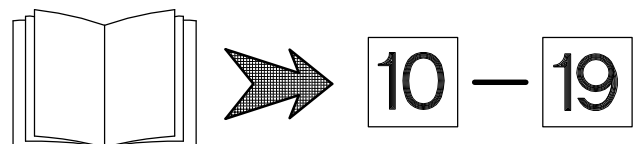
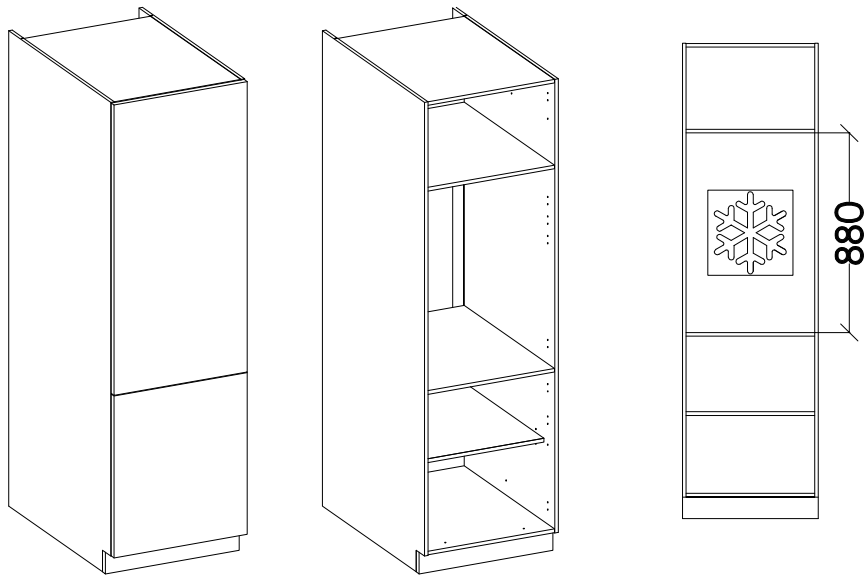

1

WARIANT A

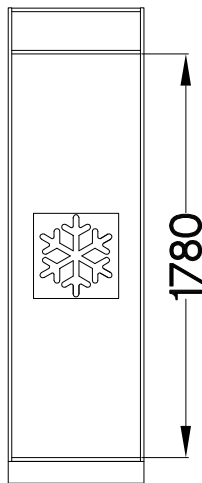
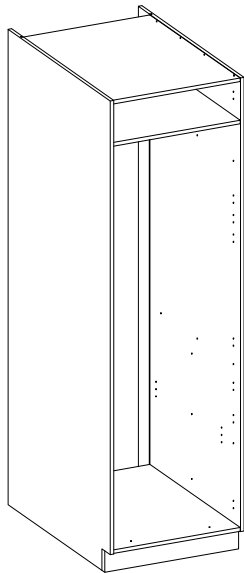

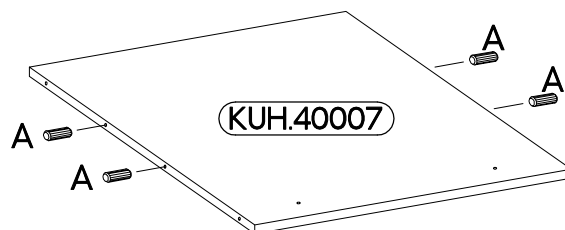
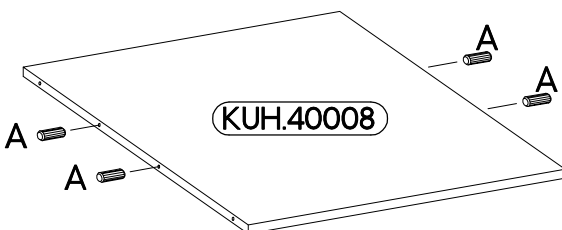
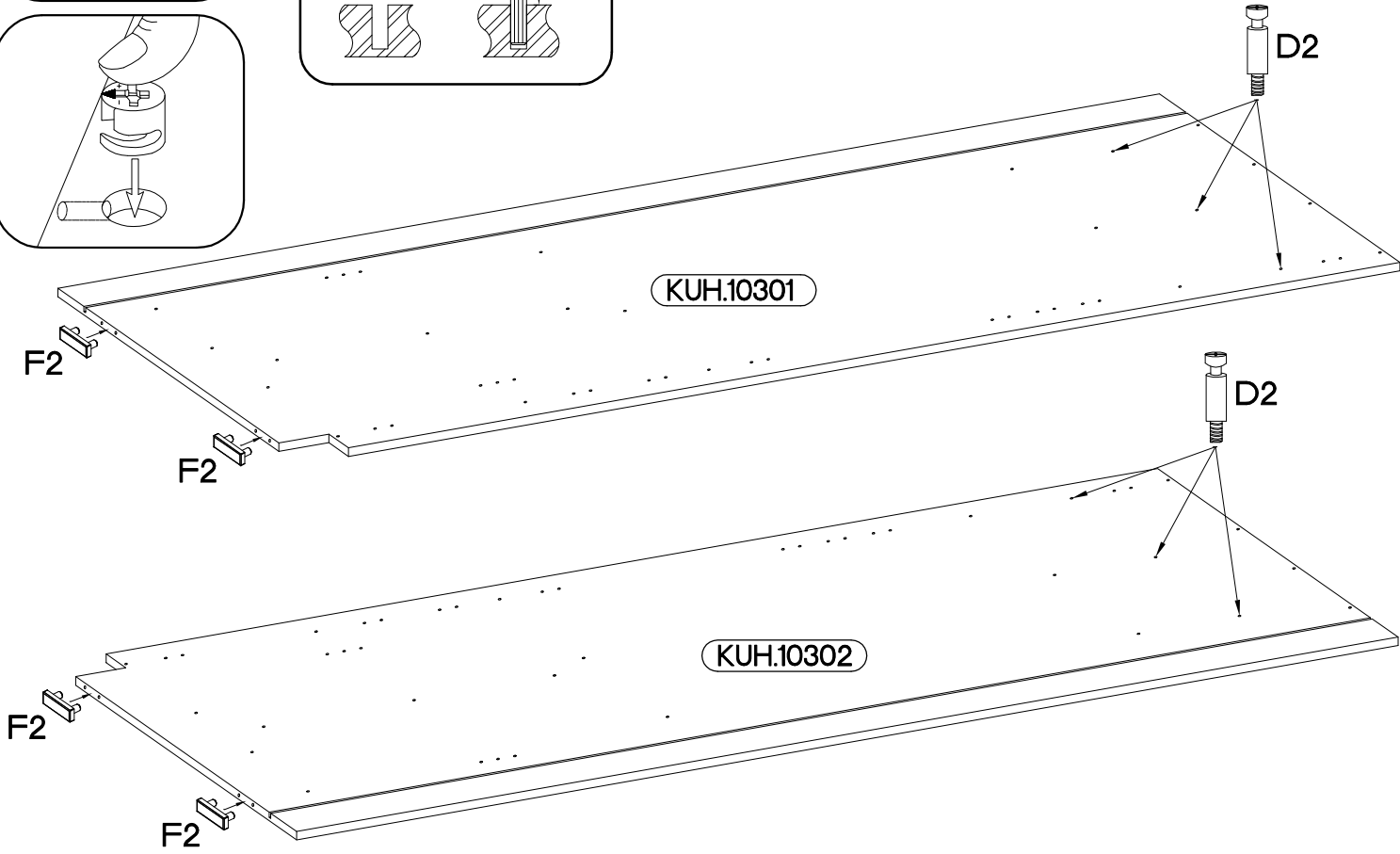
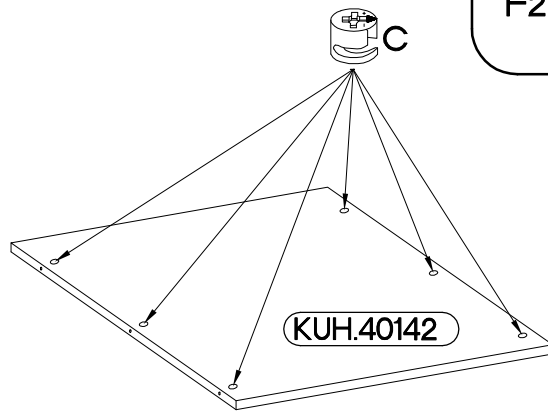
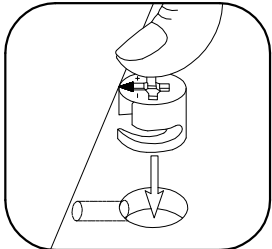
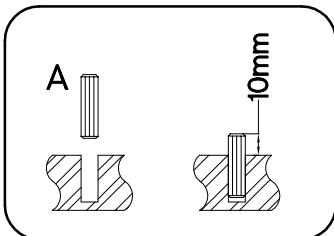
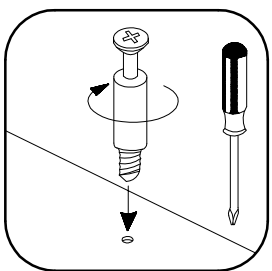
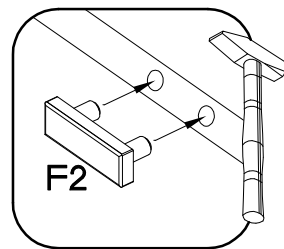
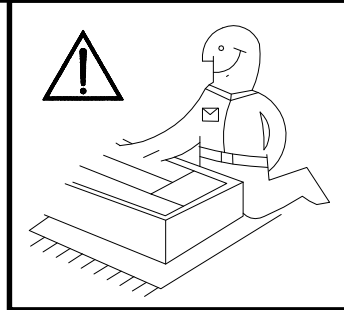

$\varnothing 8 \times 30 \text{mm}$ A	$6.5 \times 48 \times 16$ F2
8 L=20mm	4 $\varnothing 15 / 12 \text{mm}$
 D2	 C
6	6

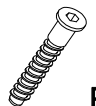
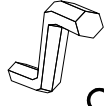

2

6,4 x 50mm

		
B	O	E1
4	1	4

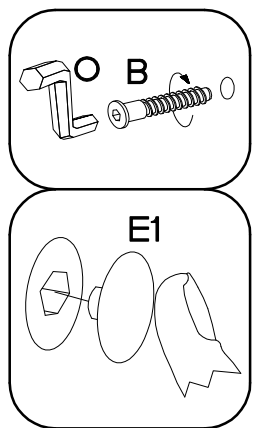
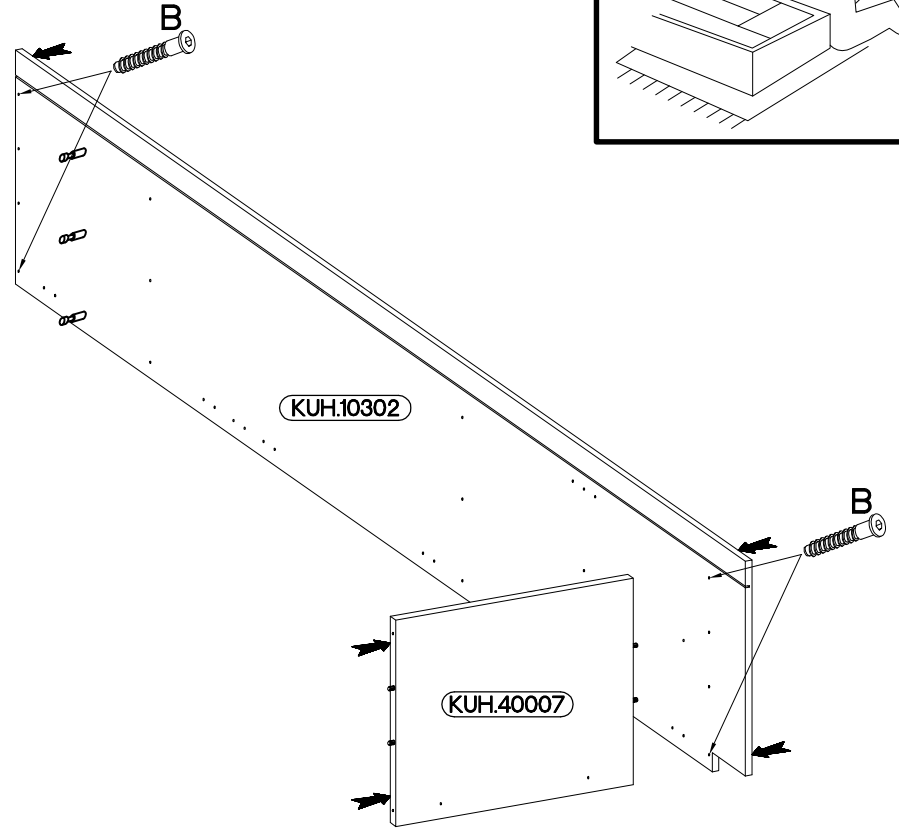
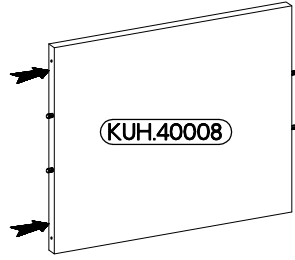
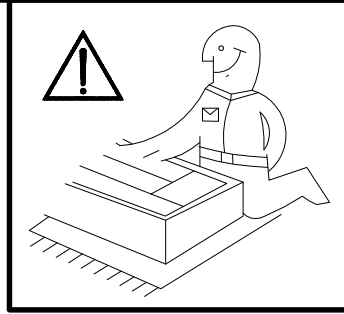



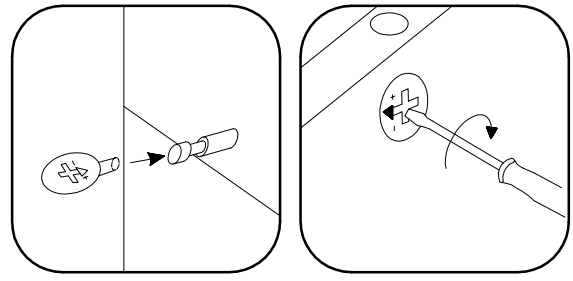
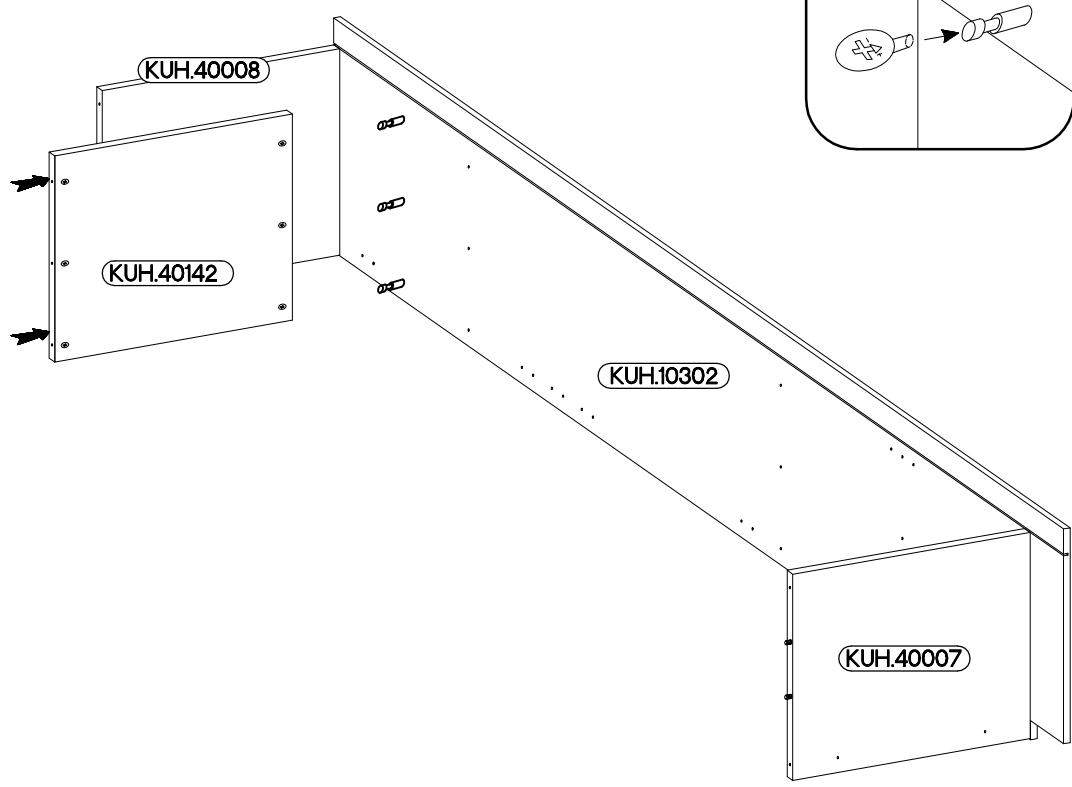

3





4

6,4 x 50mm

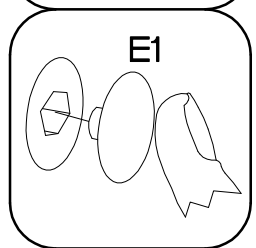
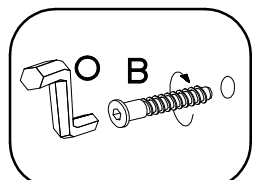
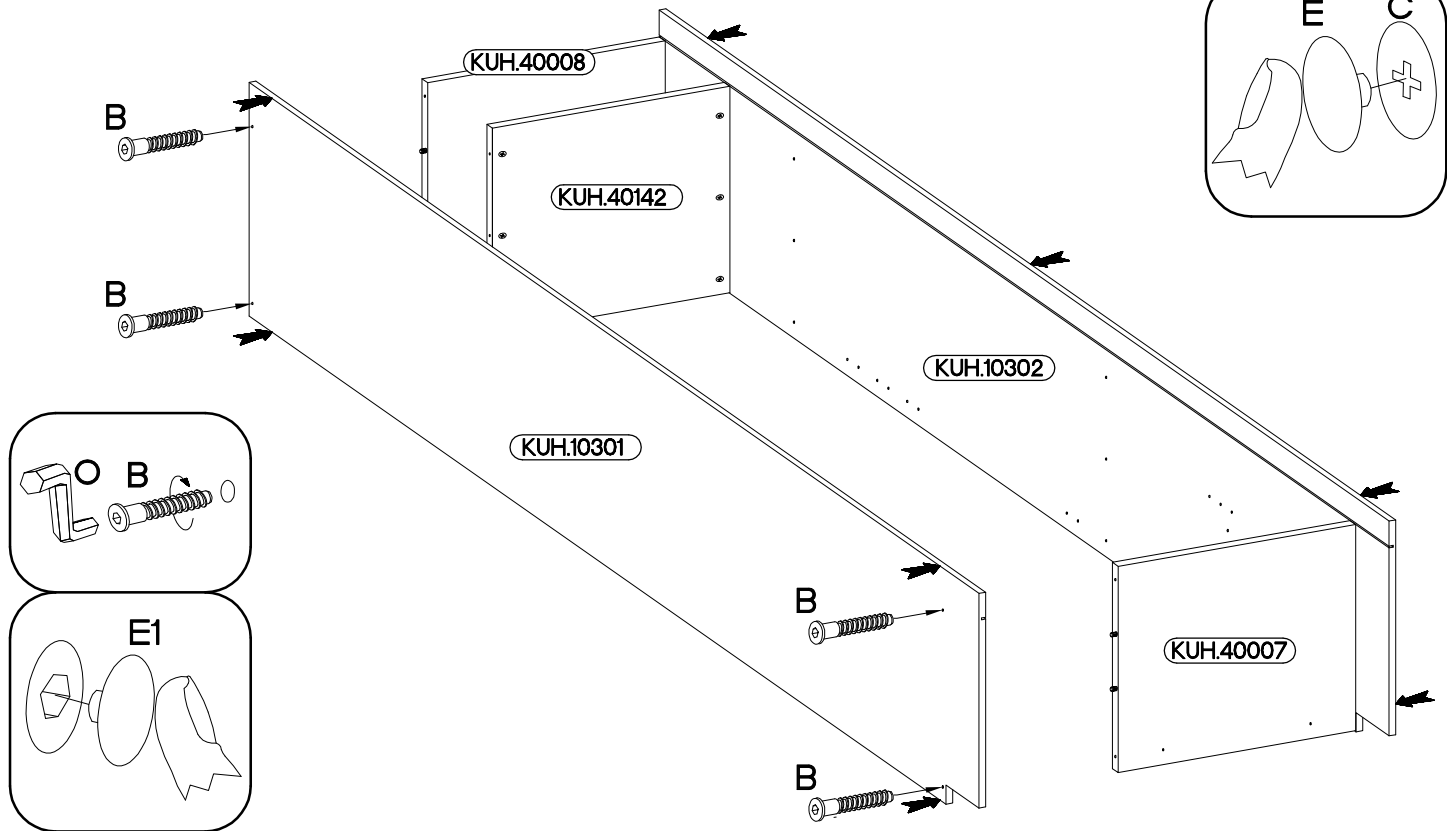
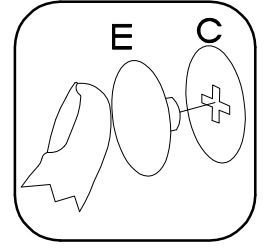
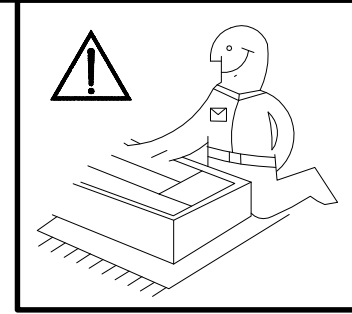
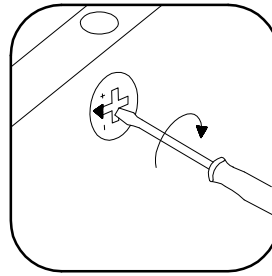
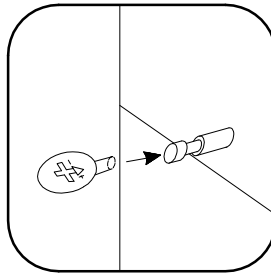
			
B	O	E1	E
4	1	4	6



5

	
T4	P1
4	16

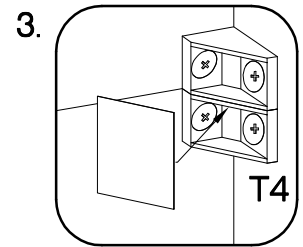
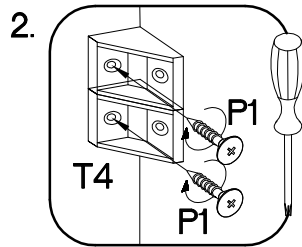
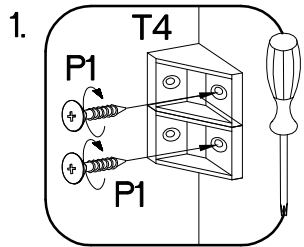
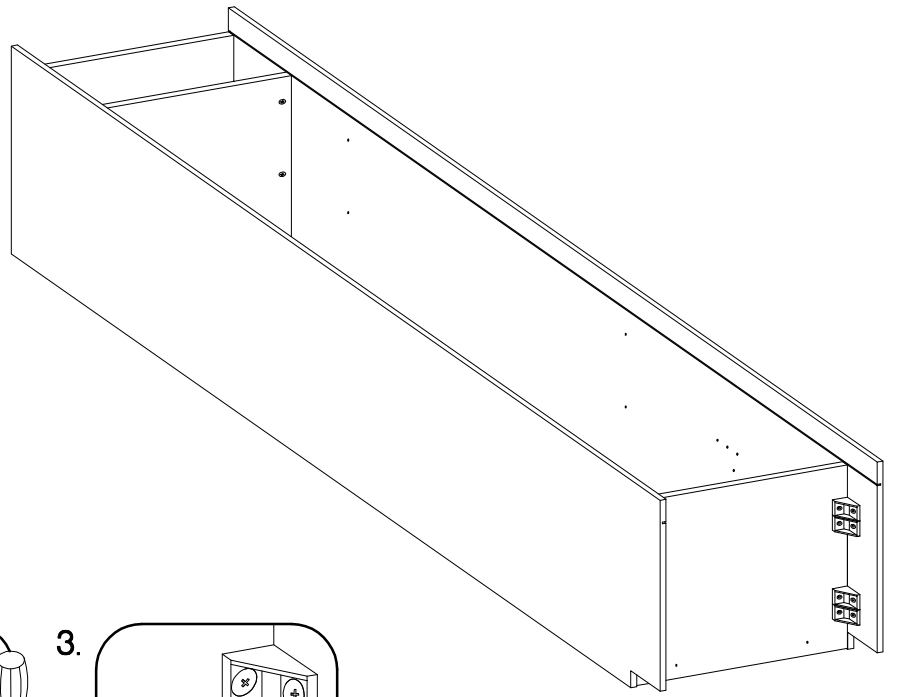
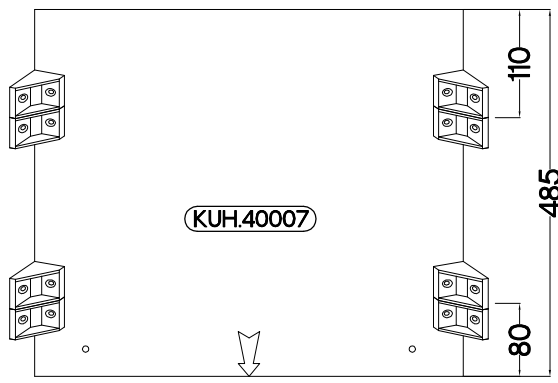

+4.0x16mm

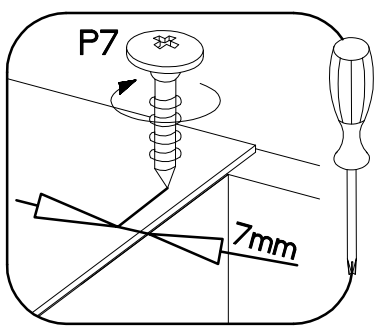
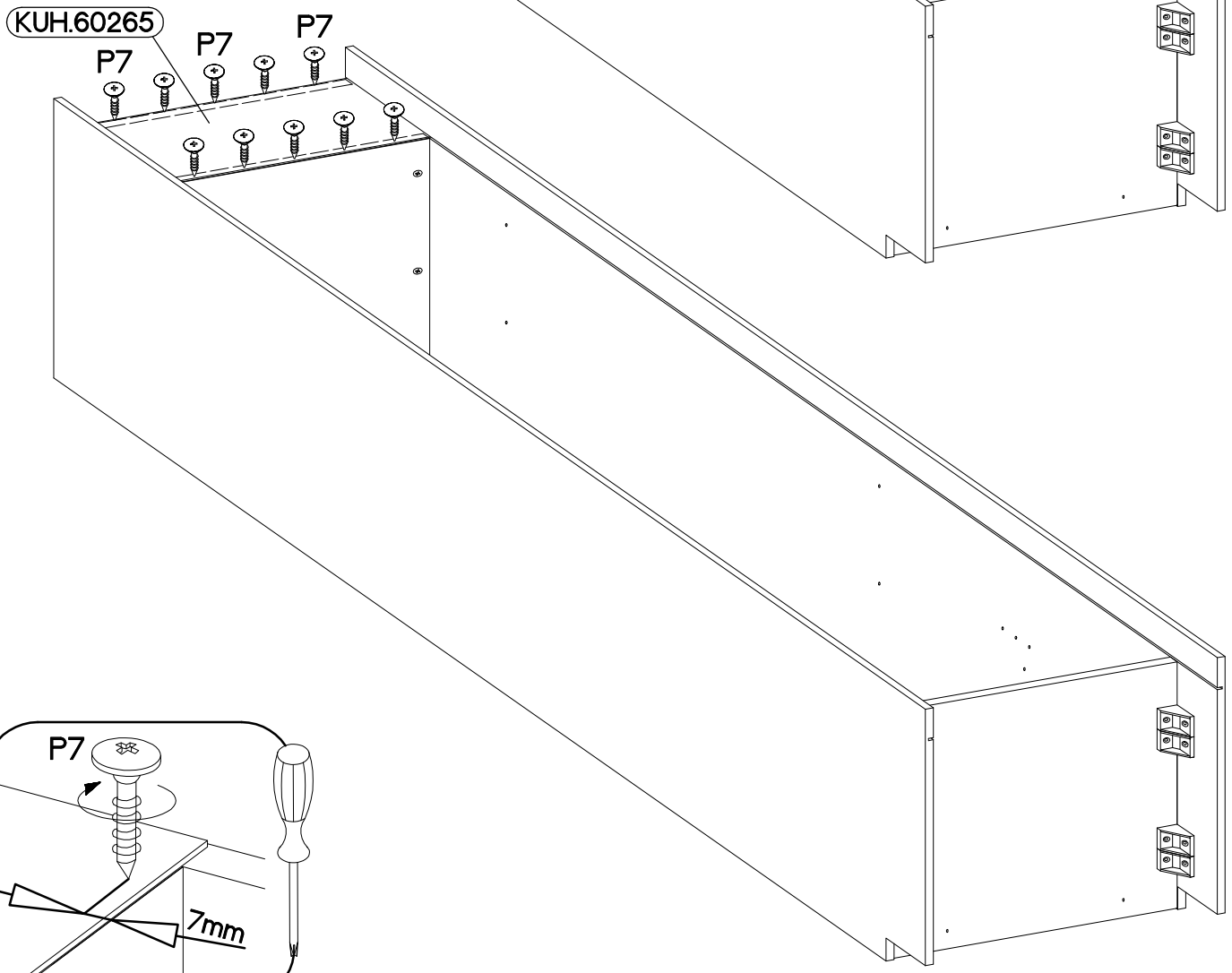
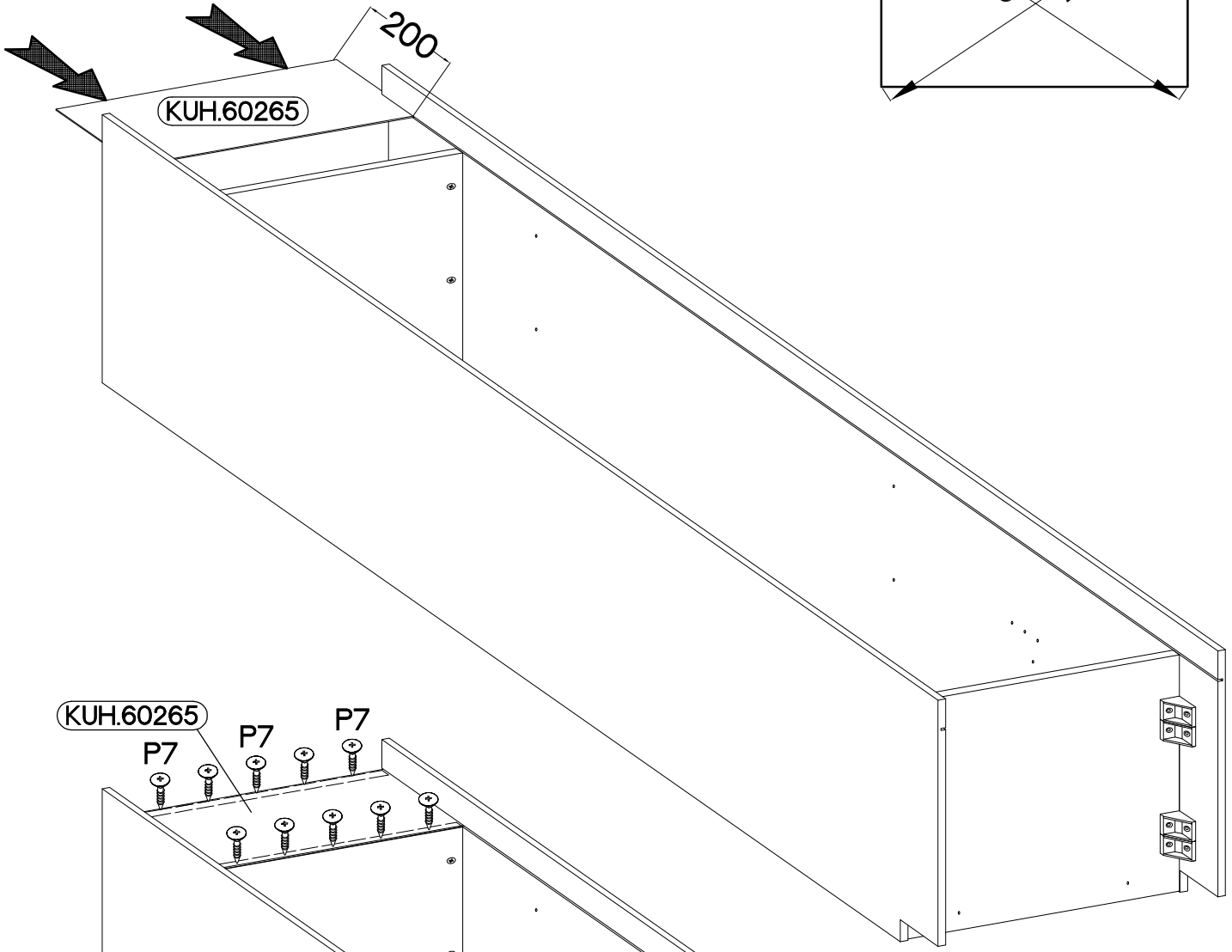
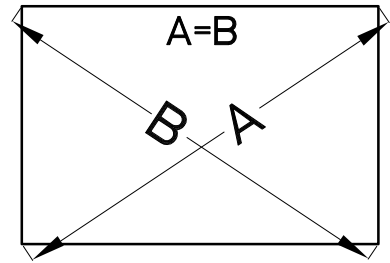

6

±3.0x20mm
P7
8-10

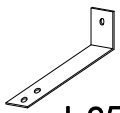

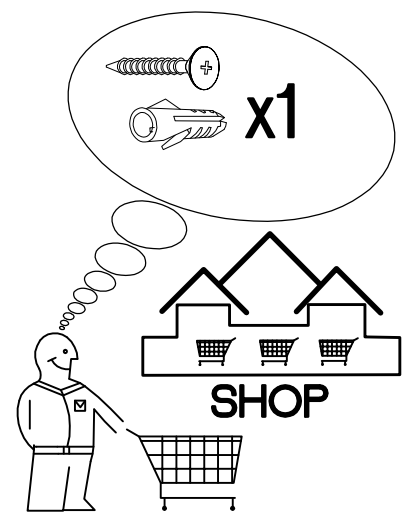
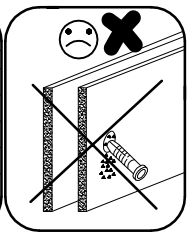
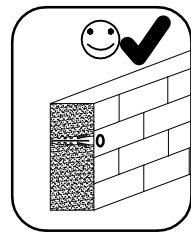
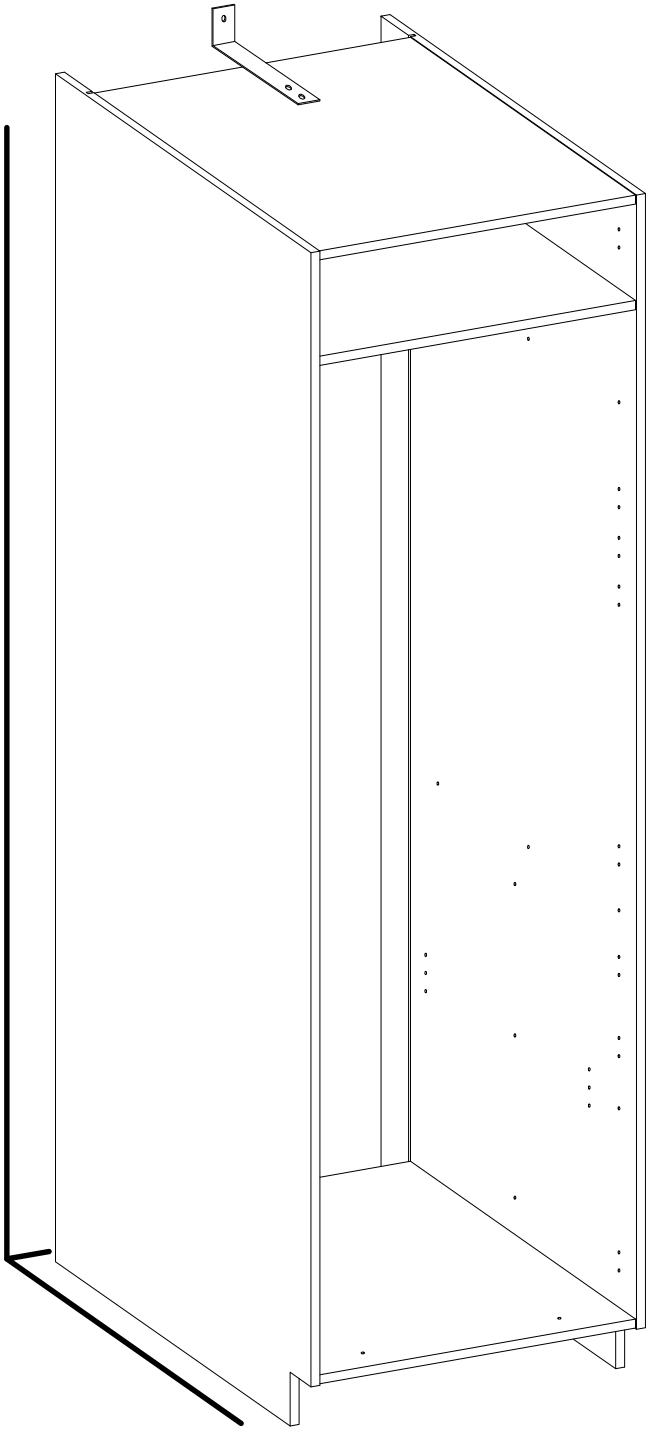
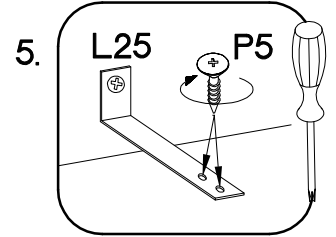
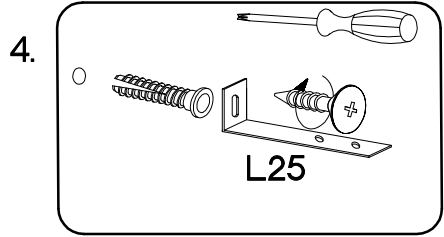
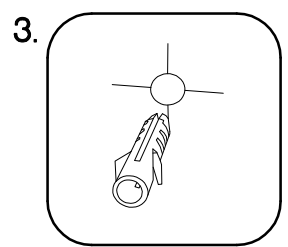
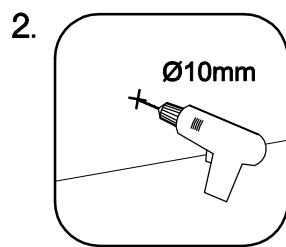
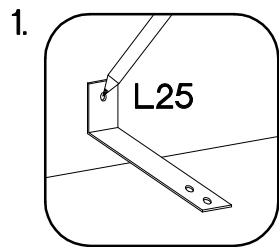

 L25 1	 P5 2
--	---

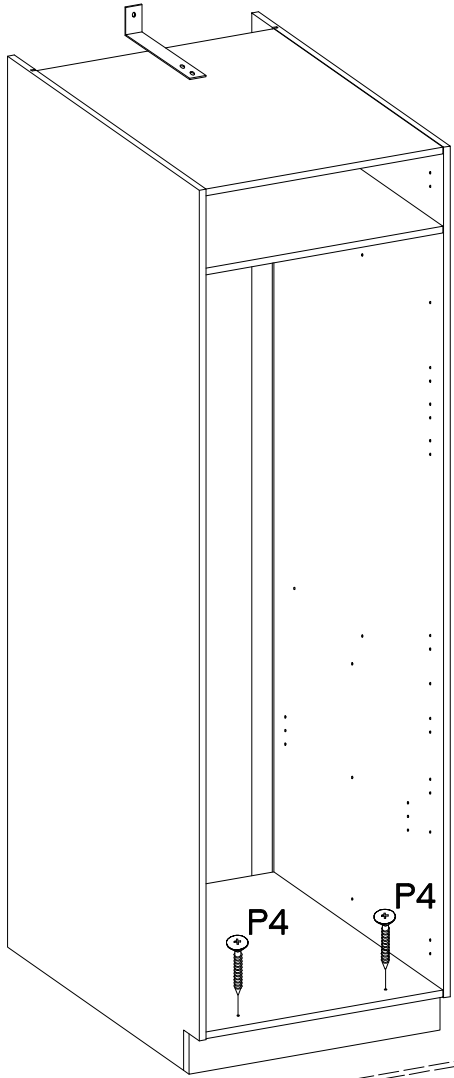

8



+4.0x45mm  P4 2	 E9 2
--	---

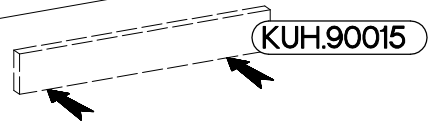
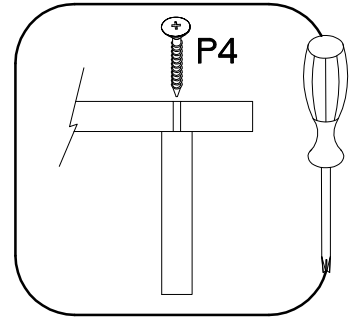

9

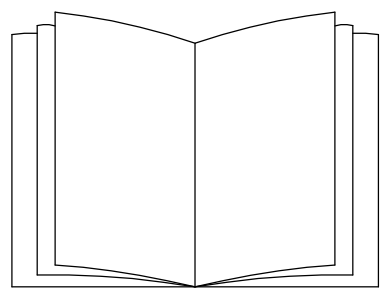
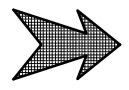
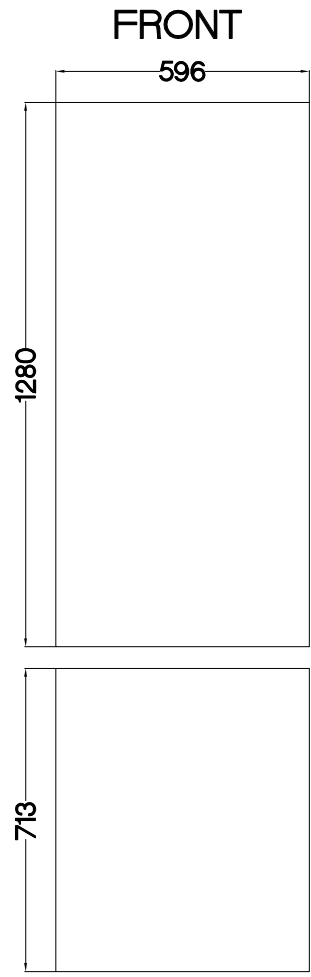
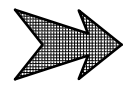
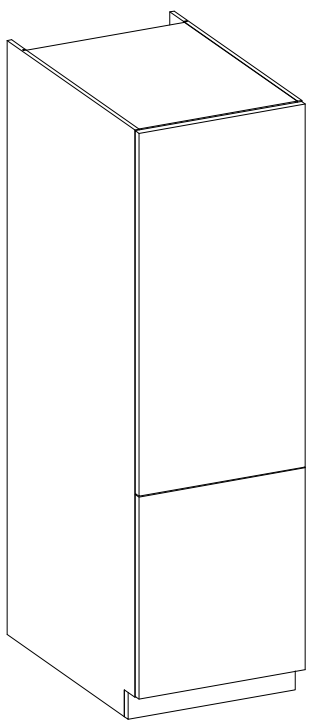

WARIANT B

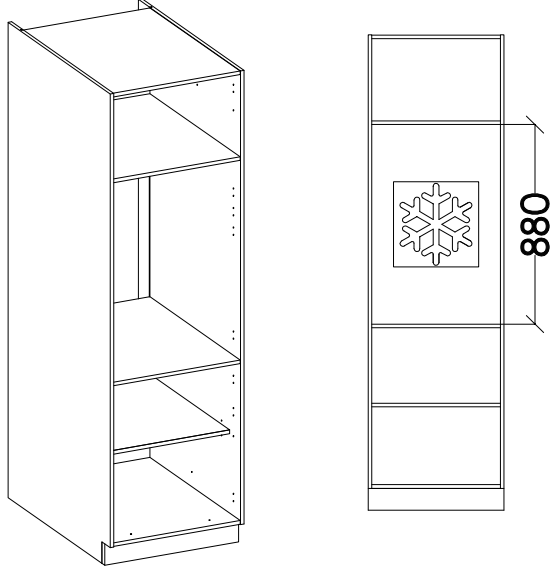

$\varnothing 8 \times 30 \text{mm}$ A	$6.5 \times 48 \times 16$ F2
8 L=20mm D2	4 $\varnothing 15 / 12 \text{mm}$ C
12	12

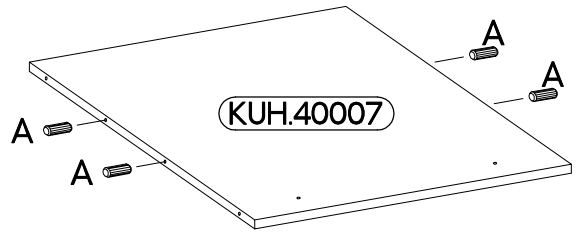
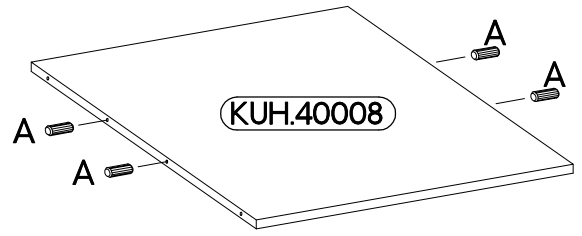
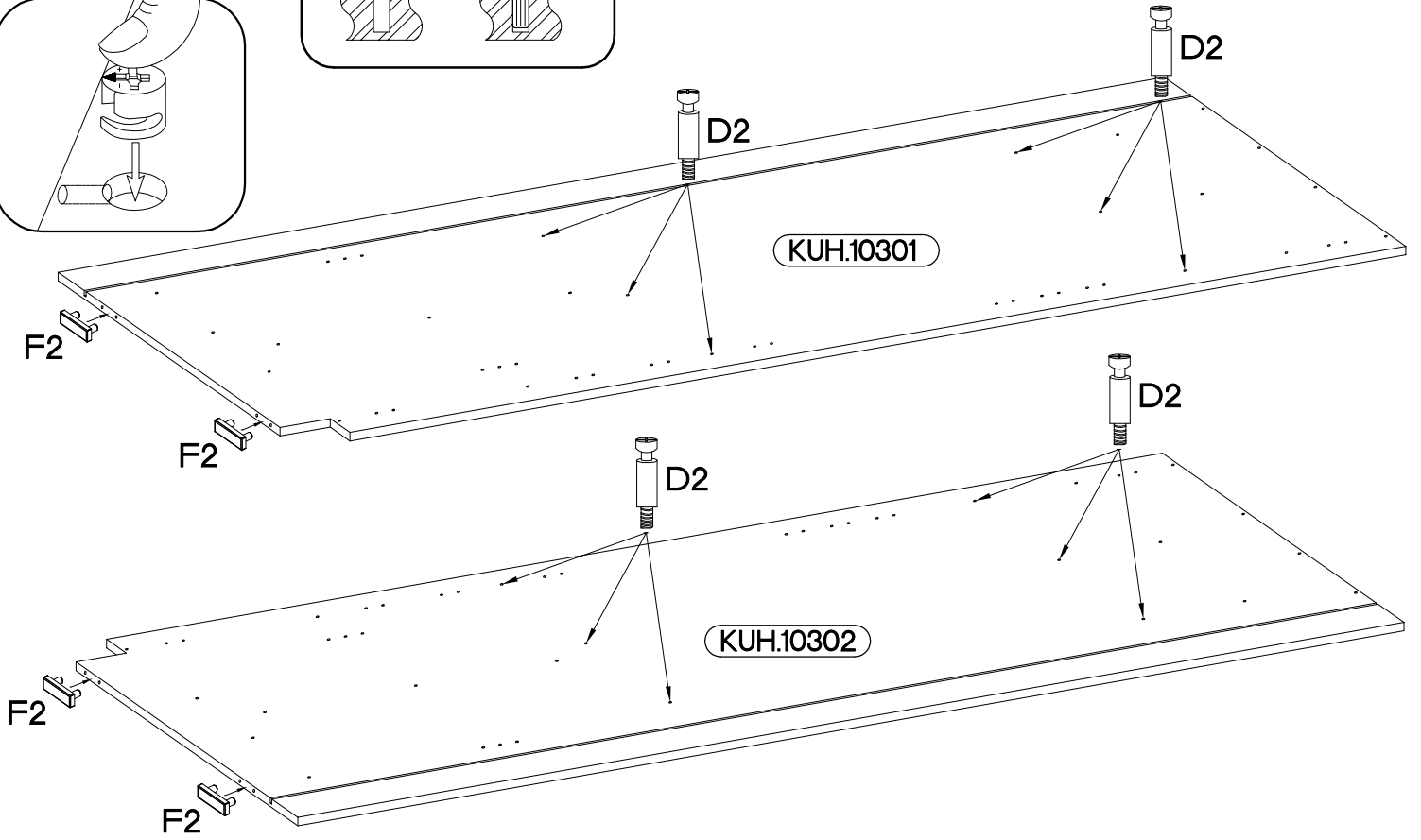
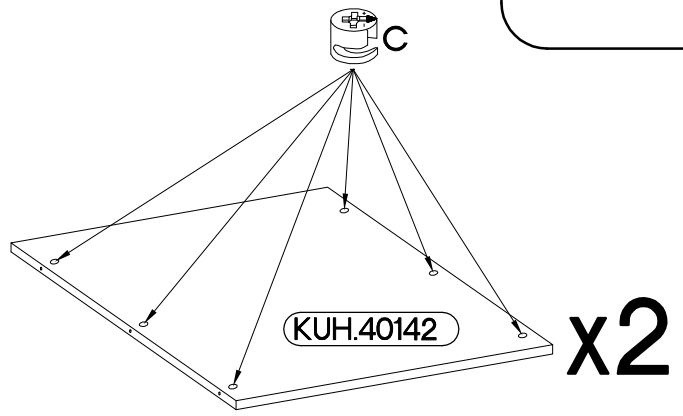
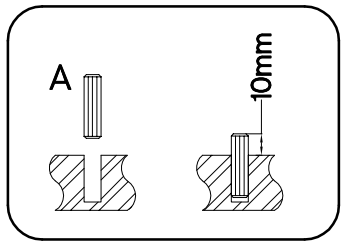
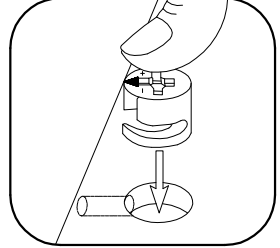
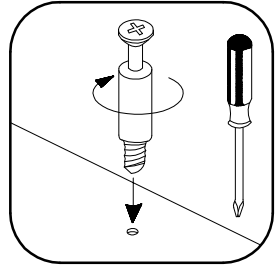
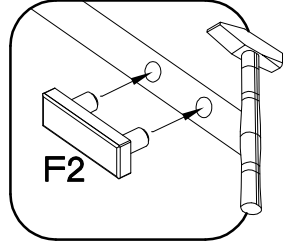
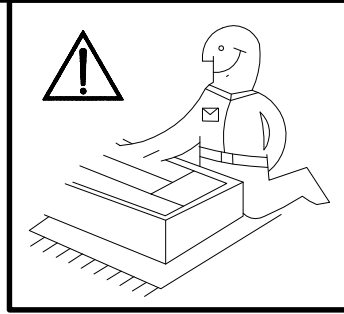

11

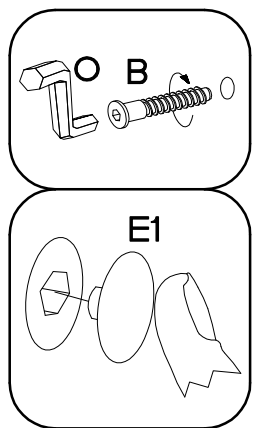
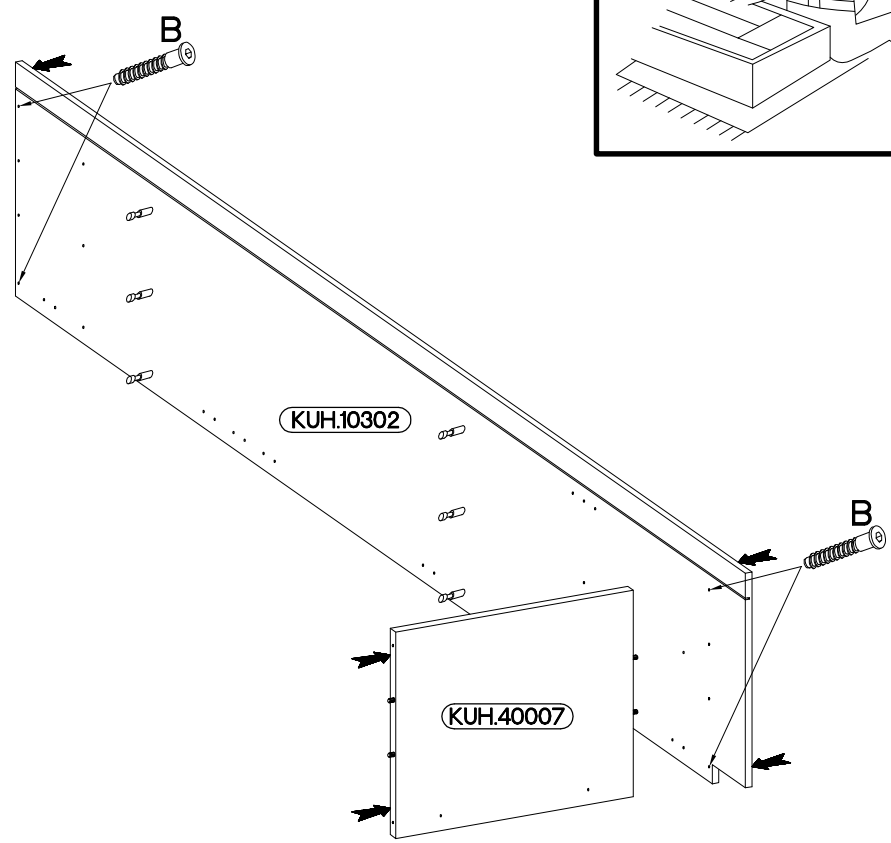
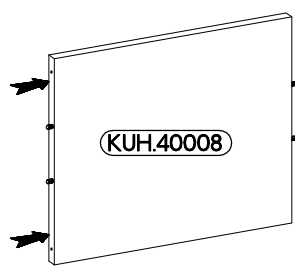
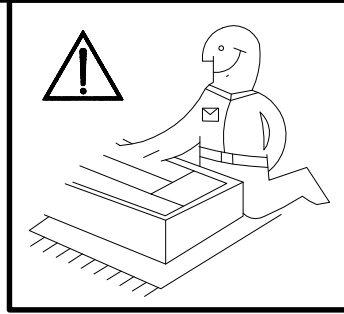
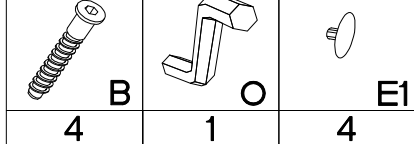

6,4 x 50mm

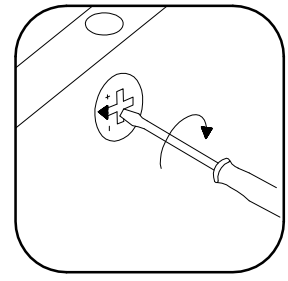
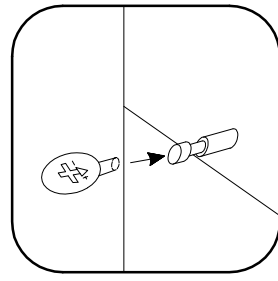
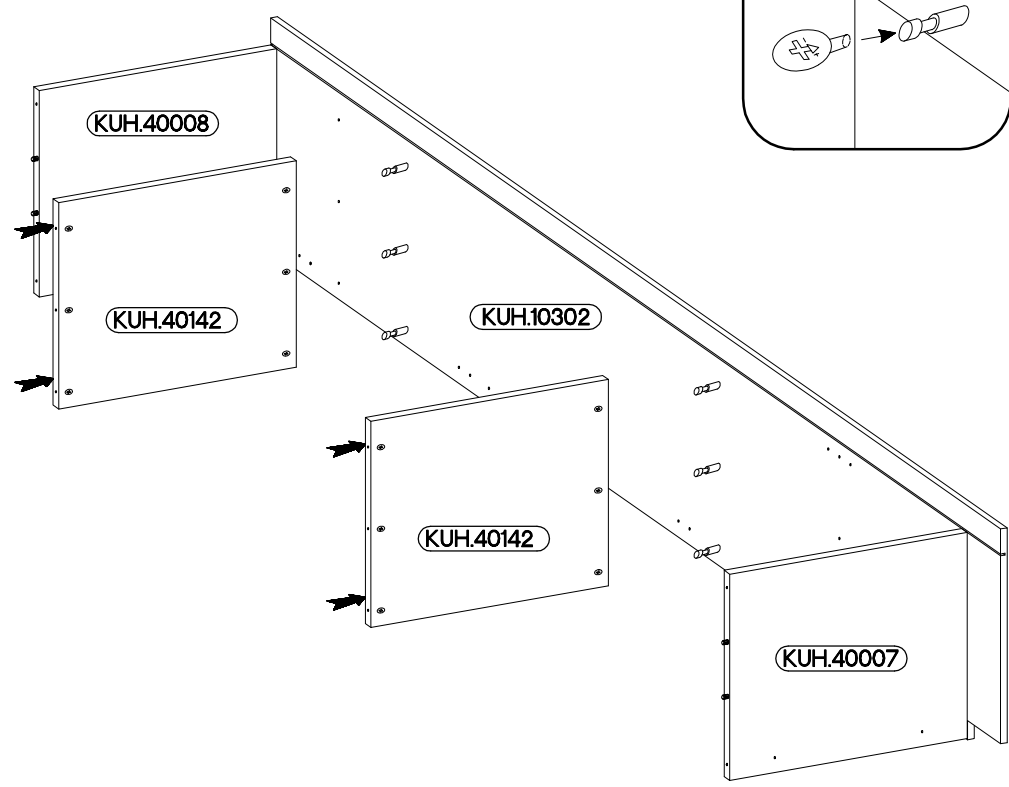

12



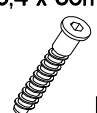
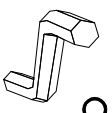

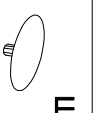
13

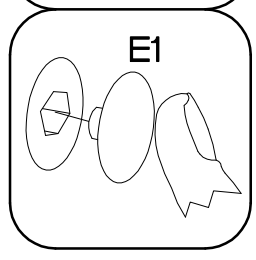
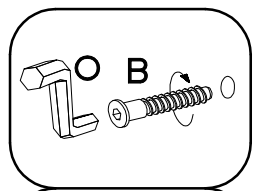
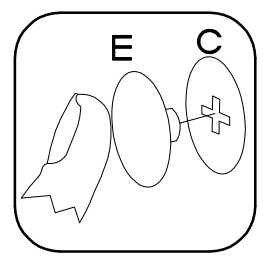
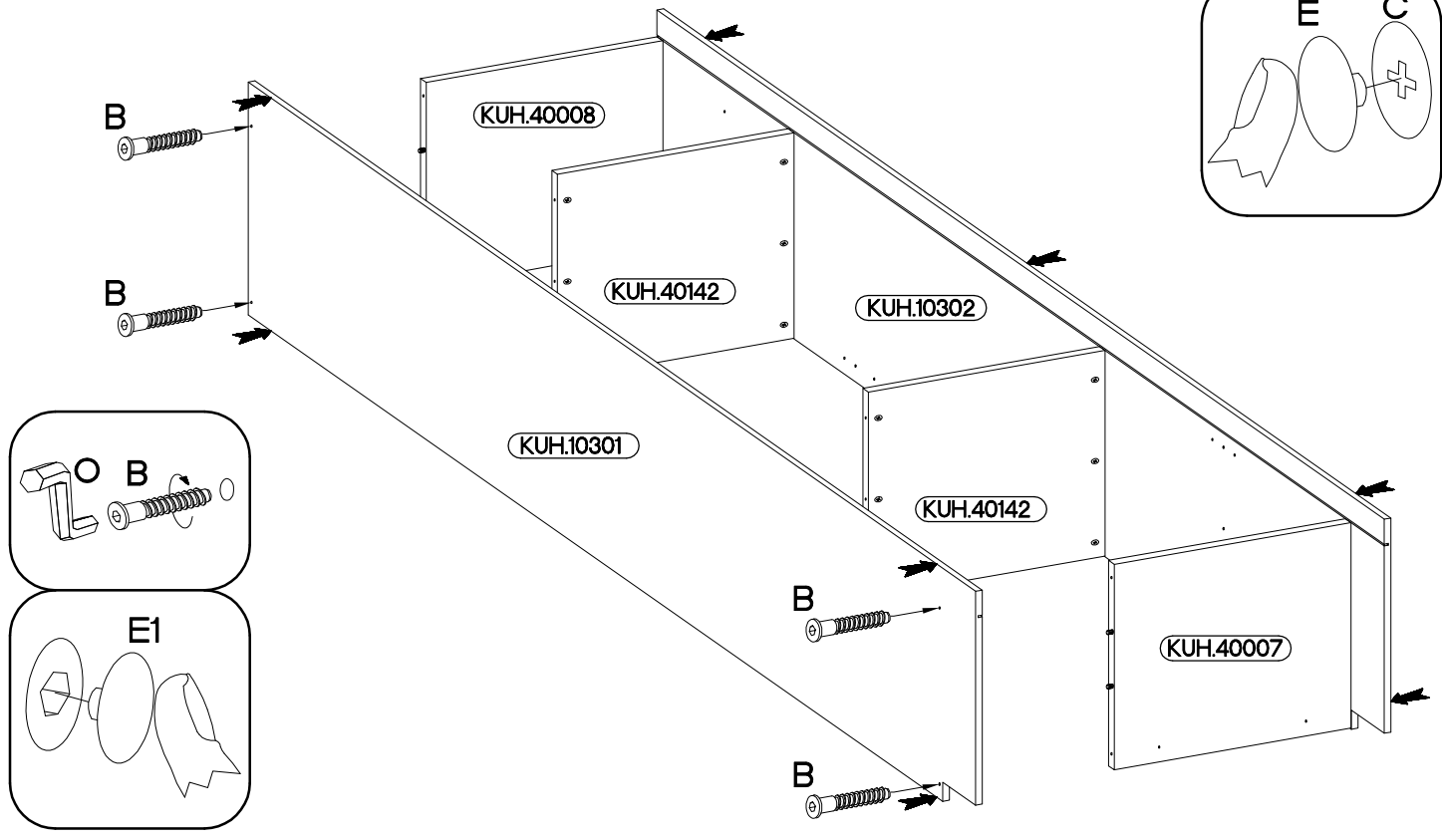
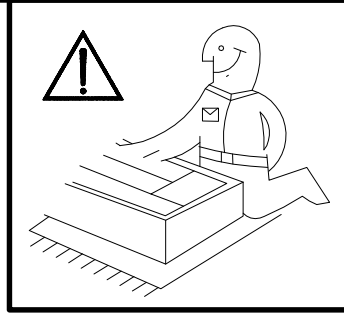
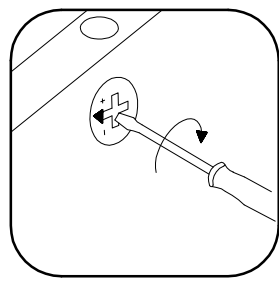
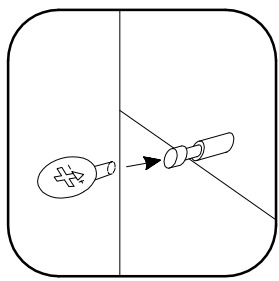
6,4 x 50mm			
			
B	O	E1	E
4	1	4	12



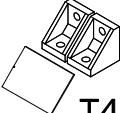

14

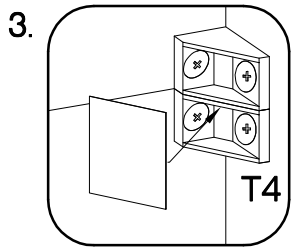
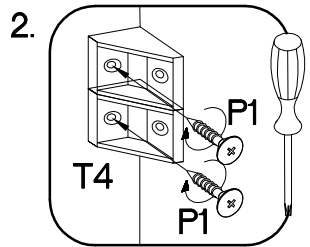
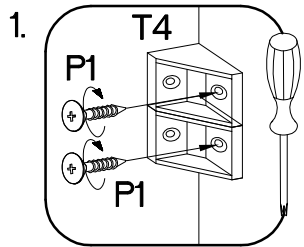
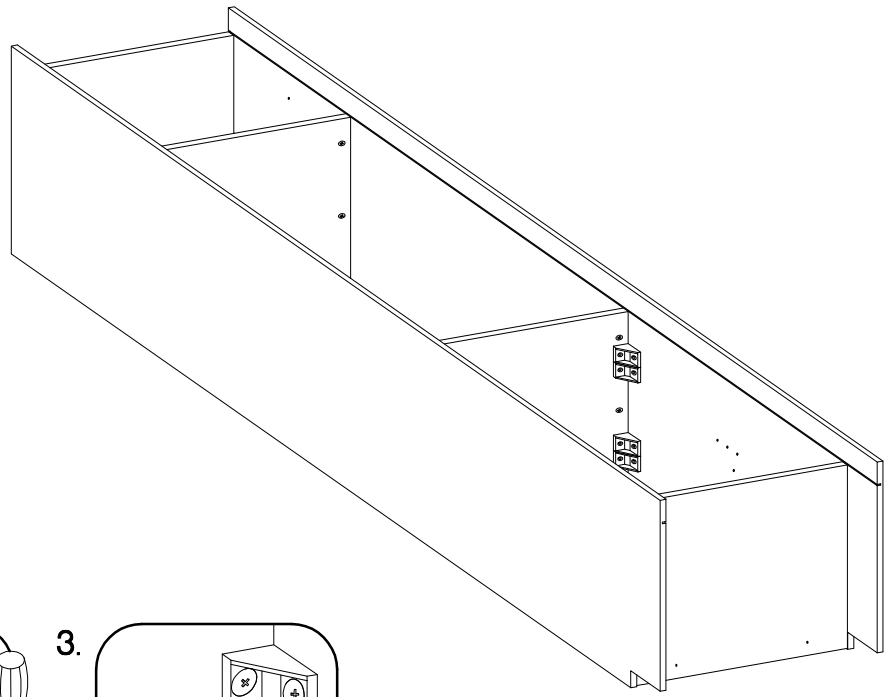
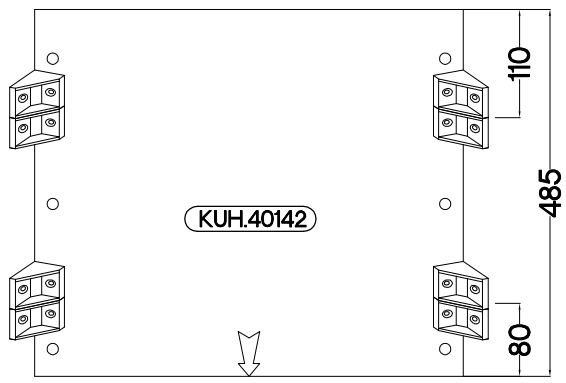
	
T4	P1
4	16



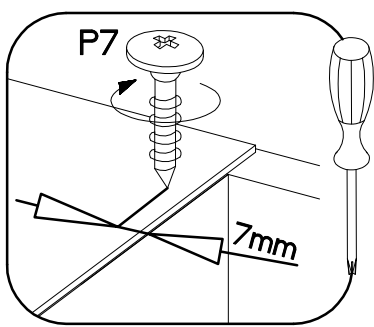
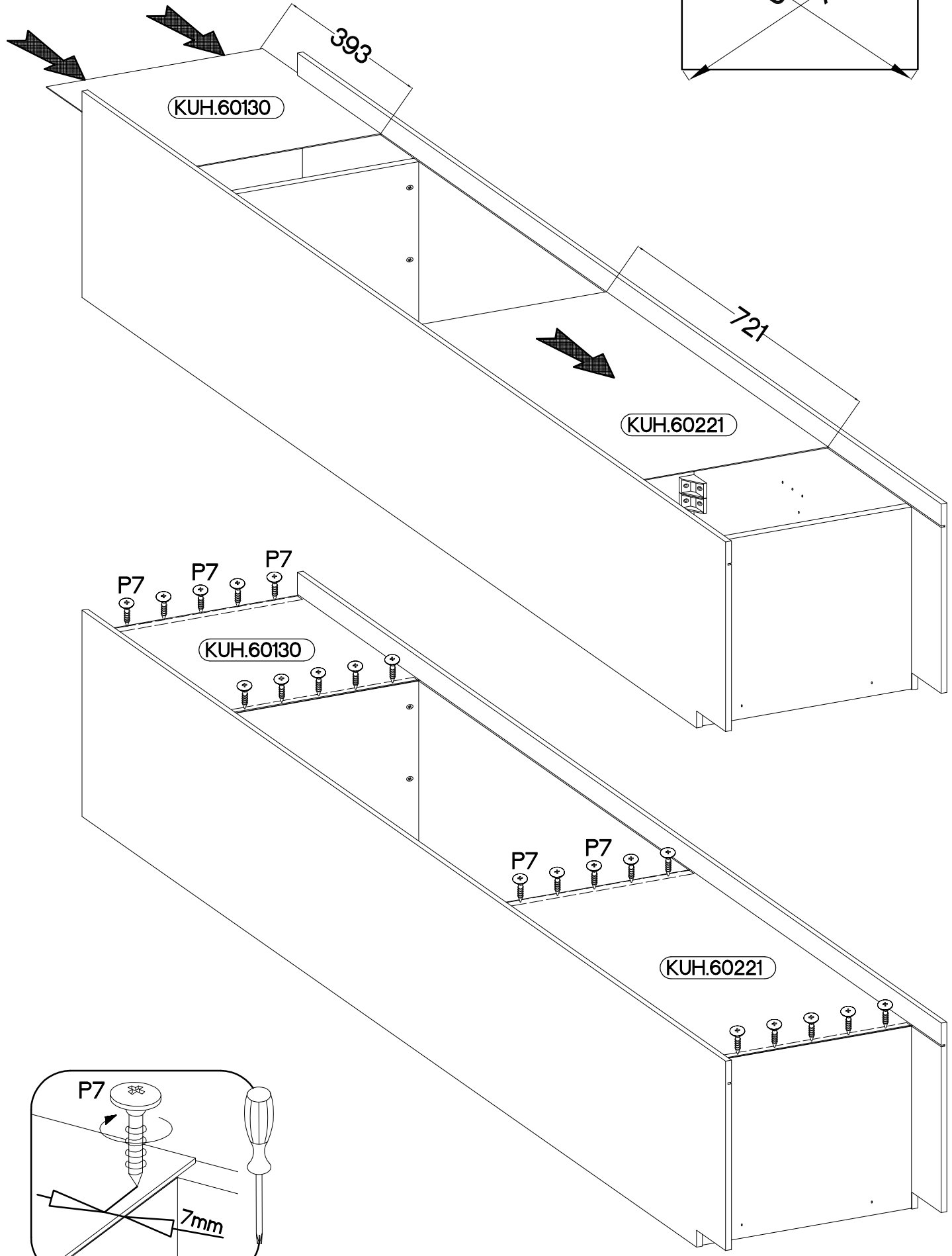
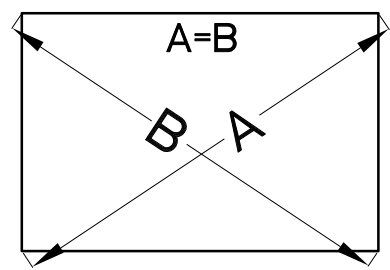

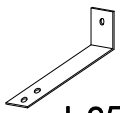
±3.0x20mm
P7
15-20

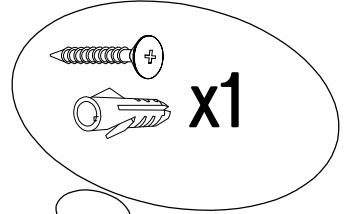
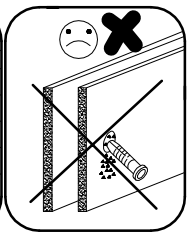
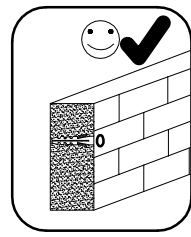
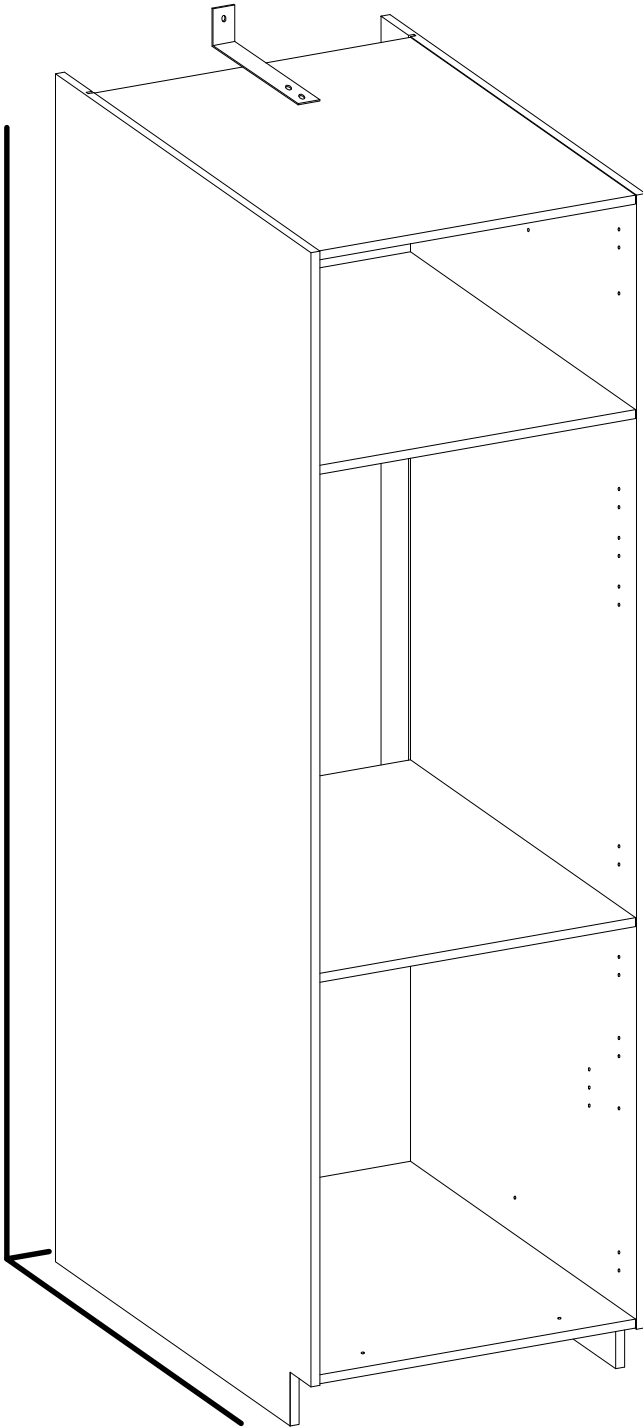
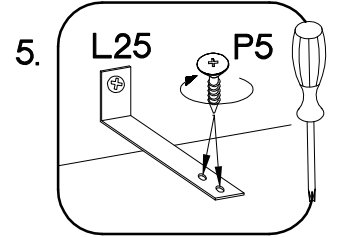
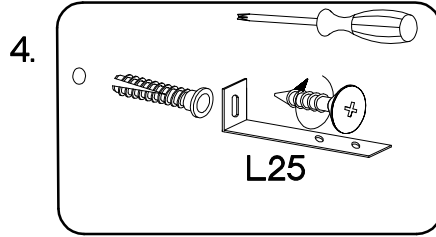
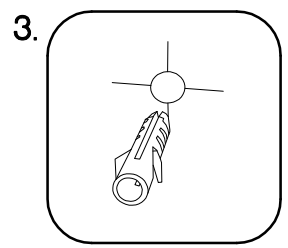
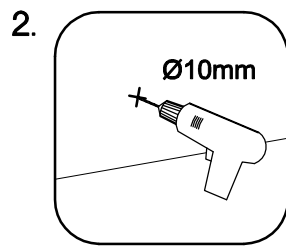
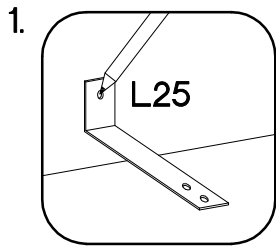

 L25 1	 P5 2
--	---



17

+4.0x45mm  P4 2	 E9 2
--	---

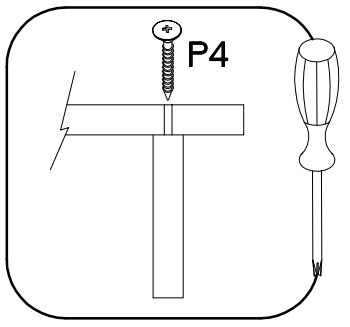
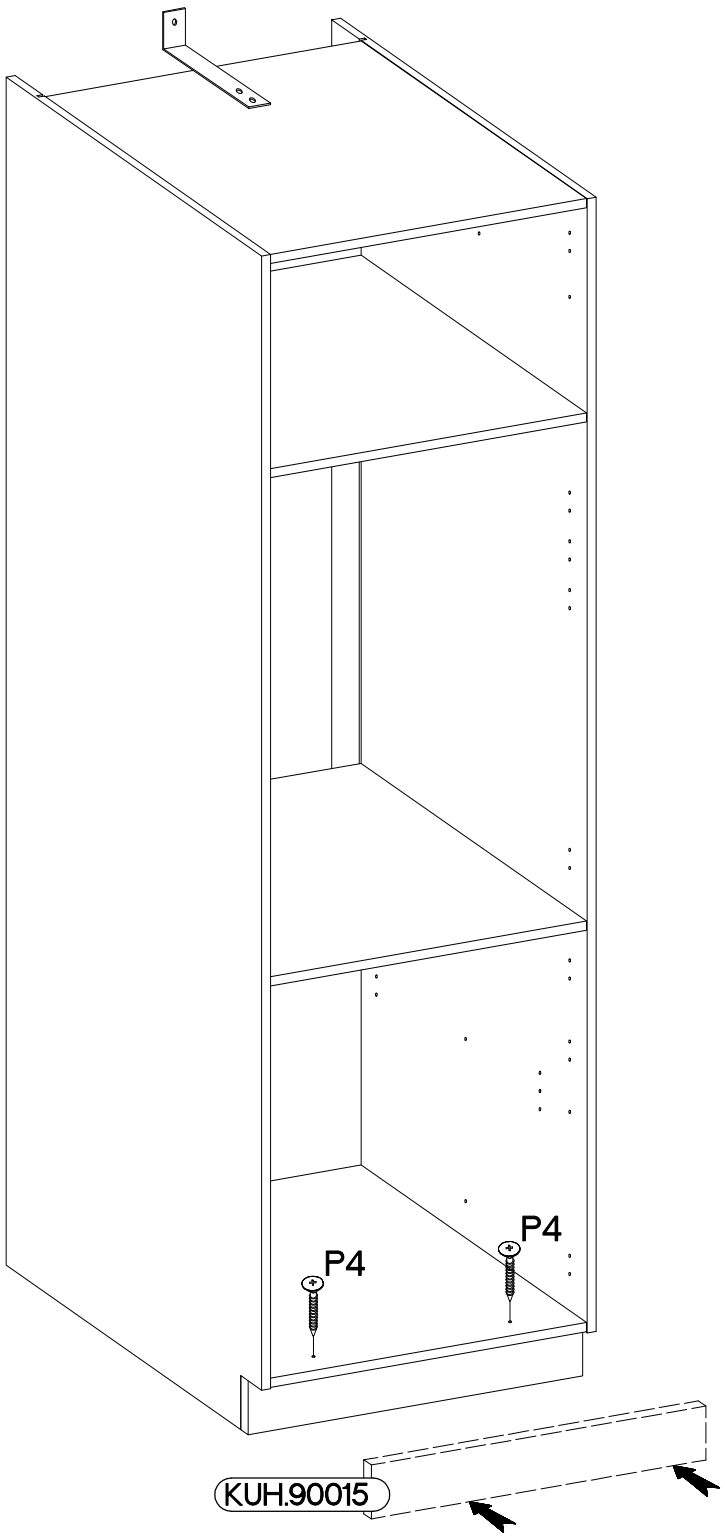

18

+5/19mm  J 4
--

