

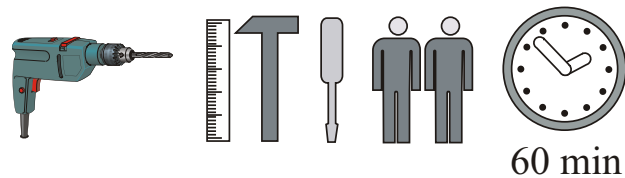

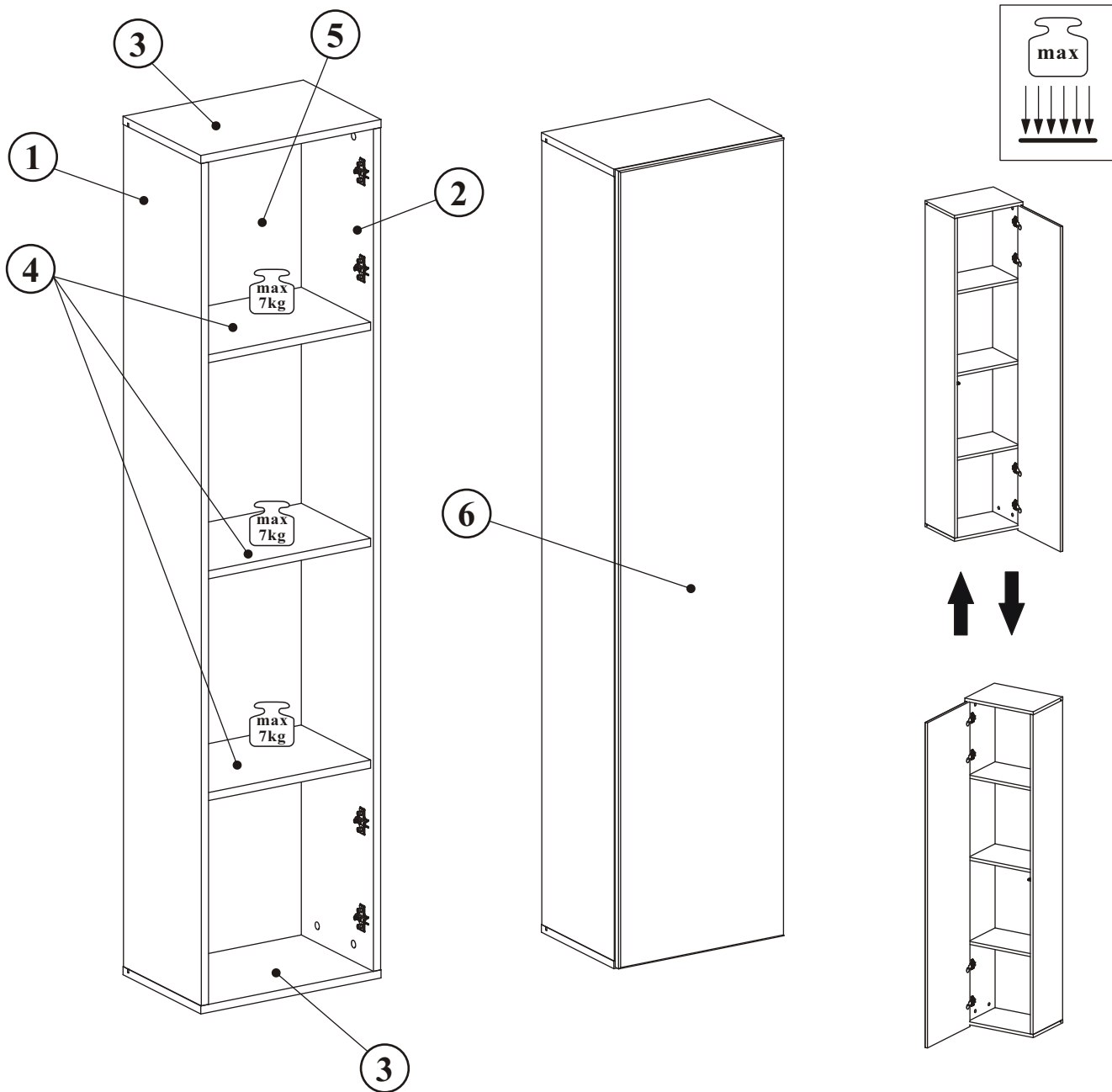

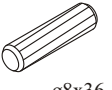

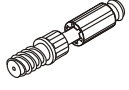

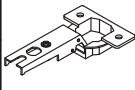
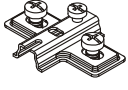
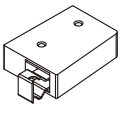

FLY TYP-40

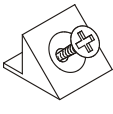

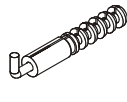
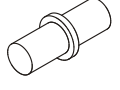
| NO | Dim. | | | Col.-No | Qty |
|----|------|------|----|---------|-----|
| 1 | 1668 | 274 | 16 | 1 | 1 |
| 2 | 1668 | 274 | 16 | 1 | 1 |
| 3 | 400 | 274 | 16 | 1 | 2 |
| 4 | 366 | 244 | 16 | 1 | 3 |
| 5 | 1680 | 378 | 3 | 1 | 1 |
| 6 | 394 | 1696 | 16 | 1 | 1 |

FLY TYP-40

| | | | | | |
|--|--|---|---|---|--|
| A1 x8  ø8x36 | B4 x8  | B5 x8  ø15x12 | G5 x8  | E1 x4  Ø26 H=0 | E2 x4  H=0 |
| ZR1 x2  | D6 x4  USØ3,5x30 | S1 x10  | D10 x10  USØ3,5x13 | KR2 x2  | G7 x12  |
| Z2 x8  Ø5 | T1 x1  | G2 x1  | | | |

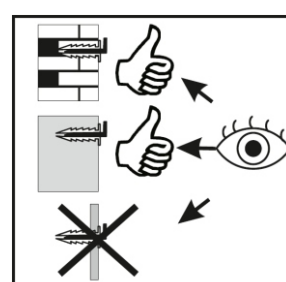
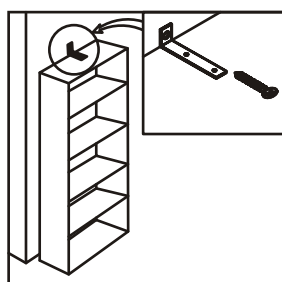
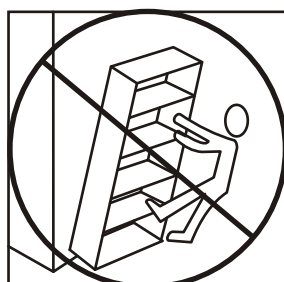
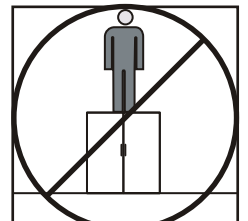
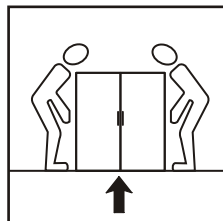
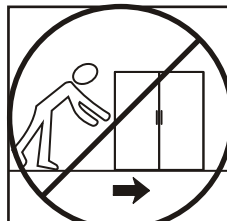
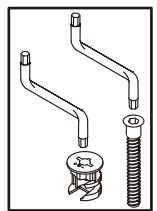
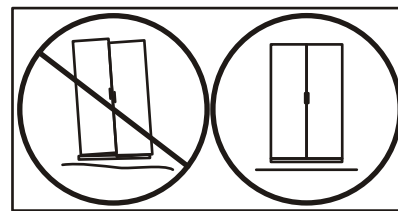
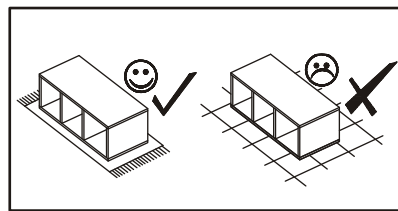
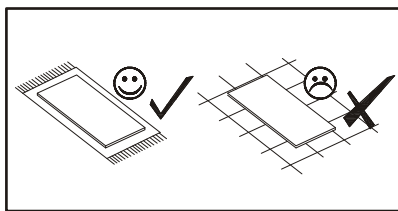
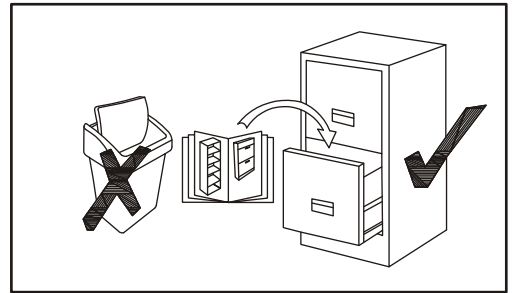
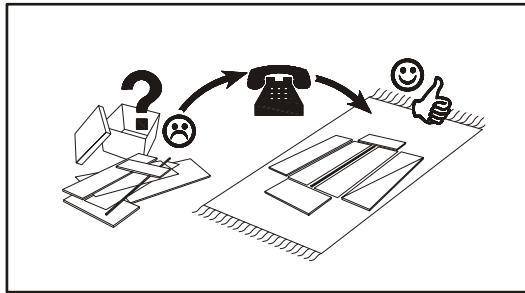
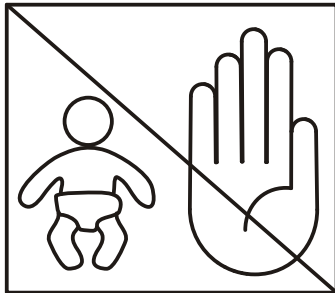
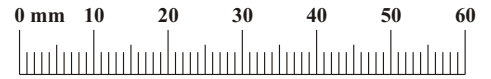

FLY TYP-40

1

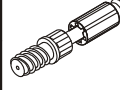
| | |
|----|--|
| B4 |  |
| x8 | |

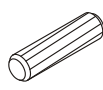
| | |
|----|---|
| A1 |  |
| x8 | ø8x36 |

| | |
|----|---|
| B5 |  |
| x8 | ø15x12 |

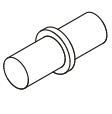
| | |
|-----|---|
| G7 |  |
| x12 | |

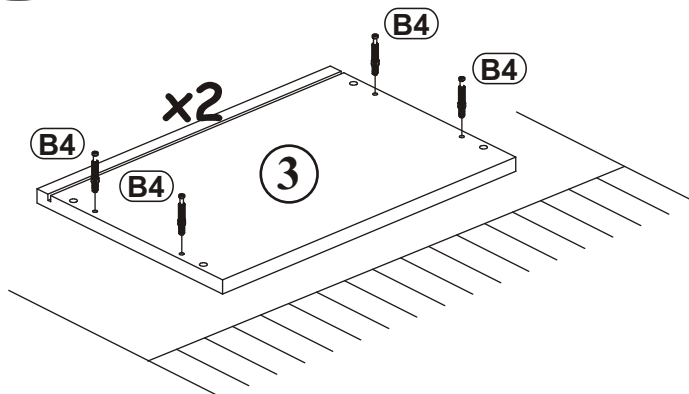
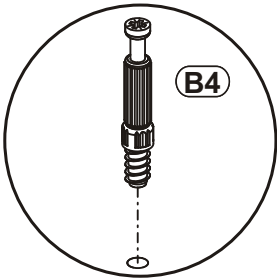
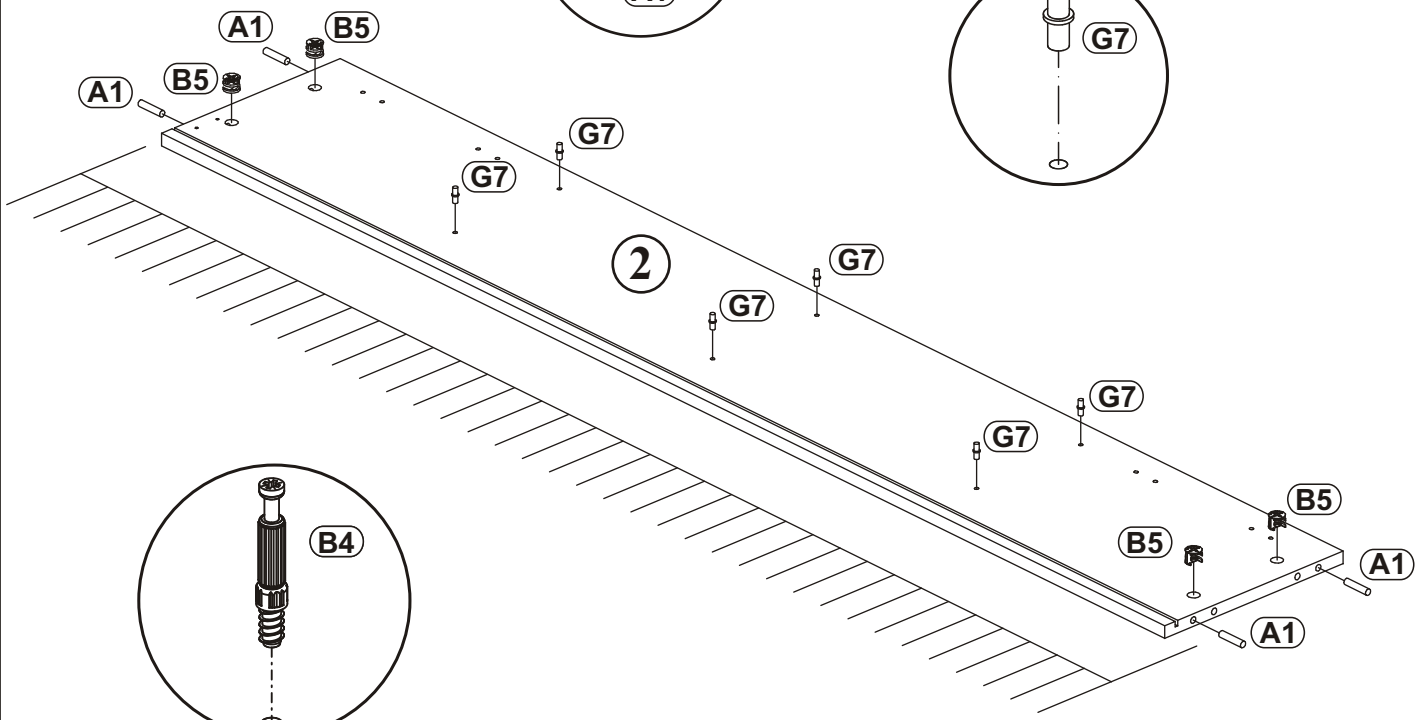
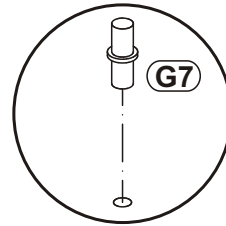
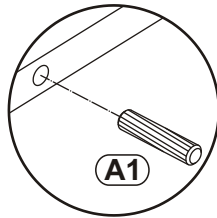
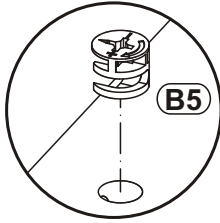
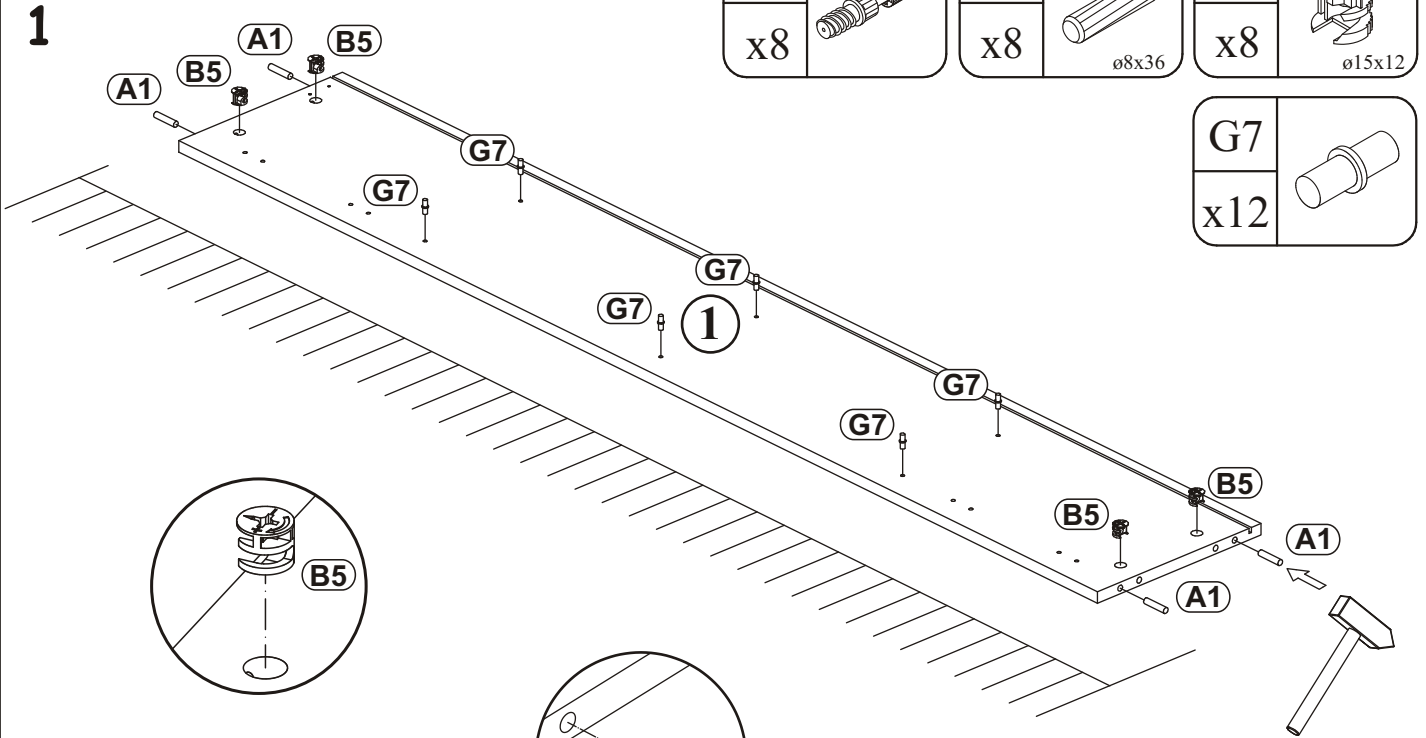

FLY TYP-40

2

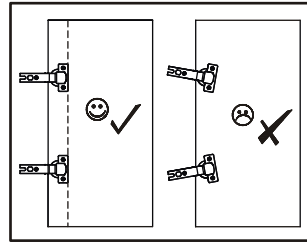

| | |
|----|---|
| E1 | Ø26 |
| x4 |  H=0 |

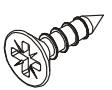
| | |
|-----|---|
| D10 |  |
| x8 | USØ3,5x13 |

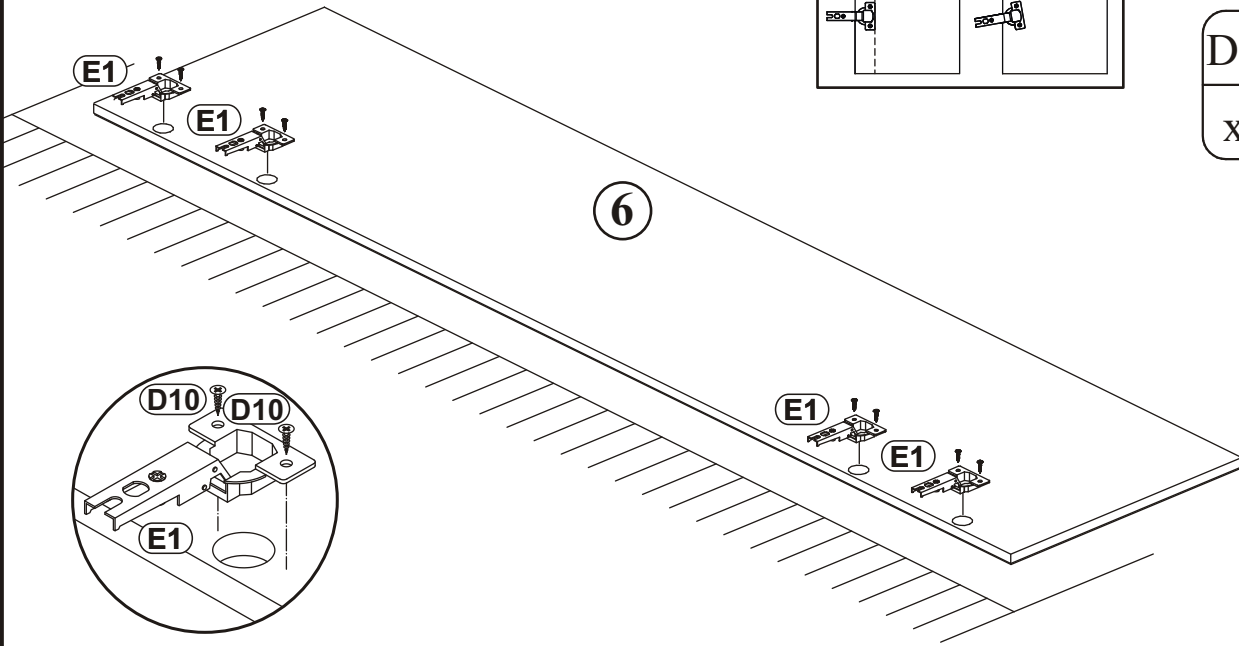

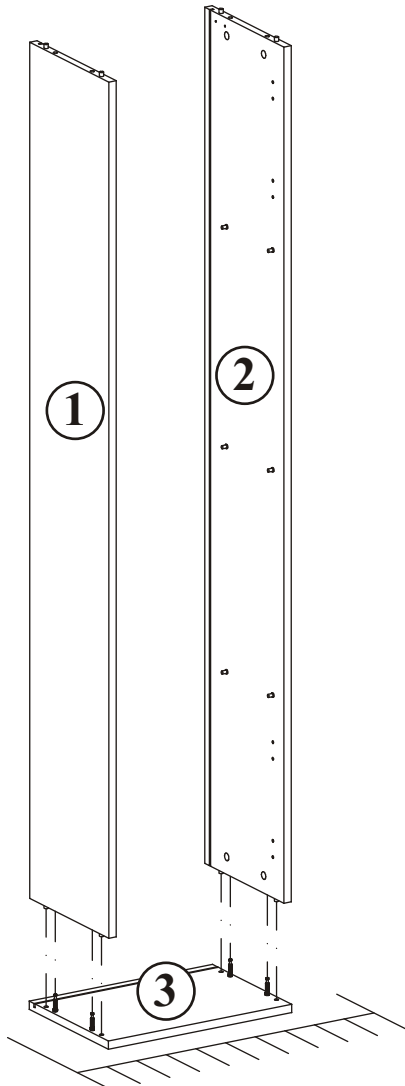

3

a)

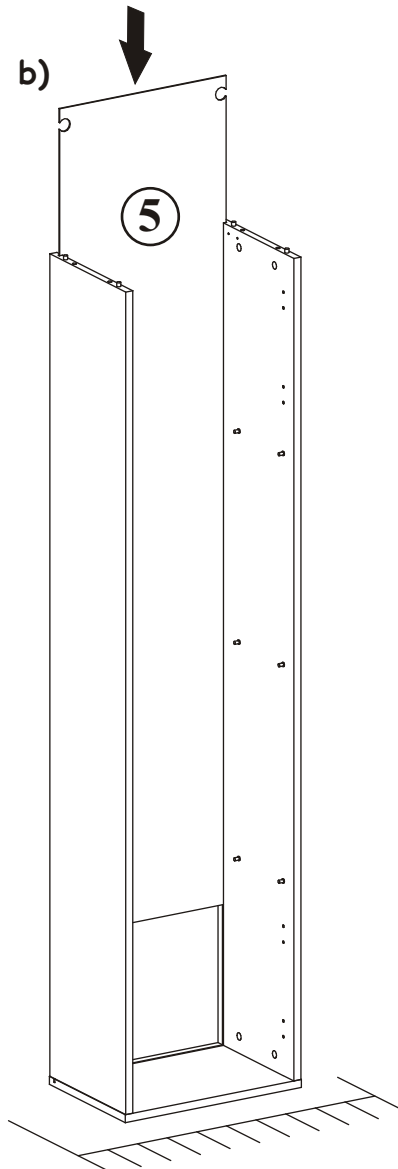

b)



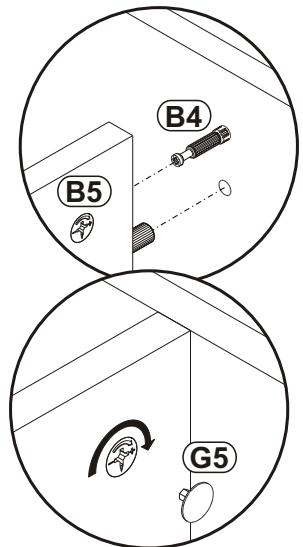

| | |
|----|---|
| G5 |  |
| x4 | |

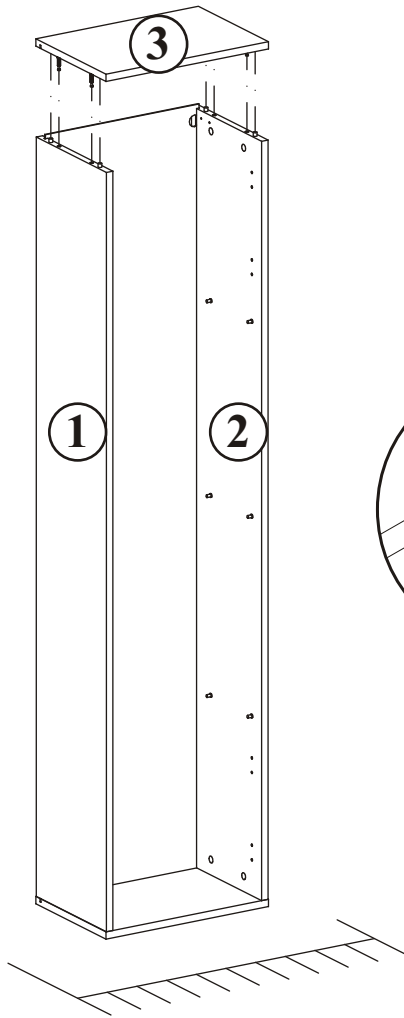

FLY TYP-40

4



| | |
|----|---|
| G5 |  |
| x4 | |

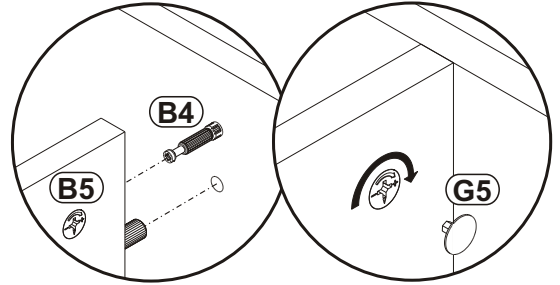

5



Y

X

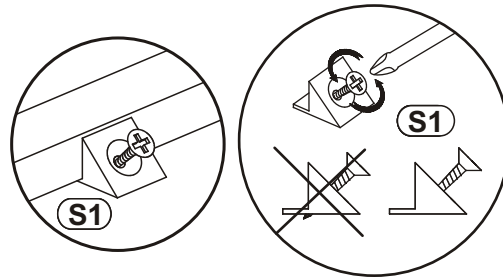

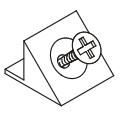
| | |
|-----|---|
| S1 |  |
| x12 | |

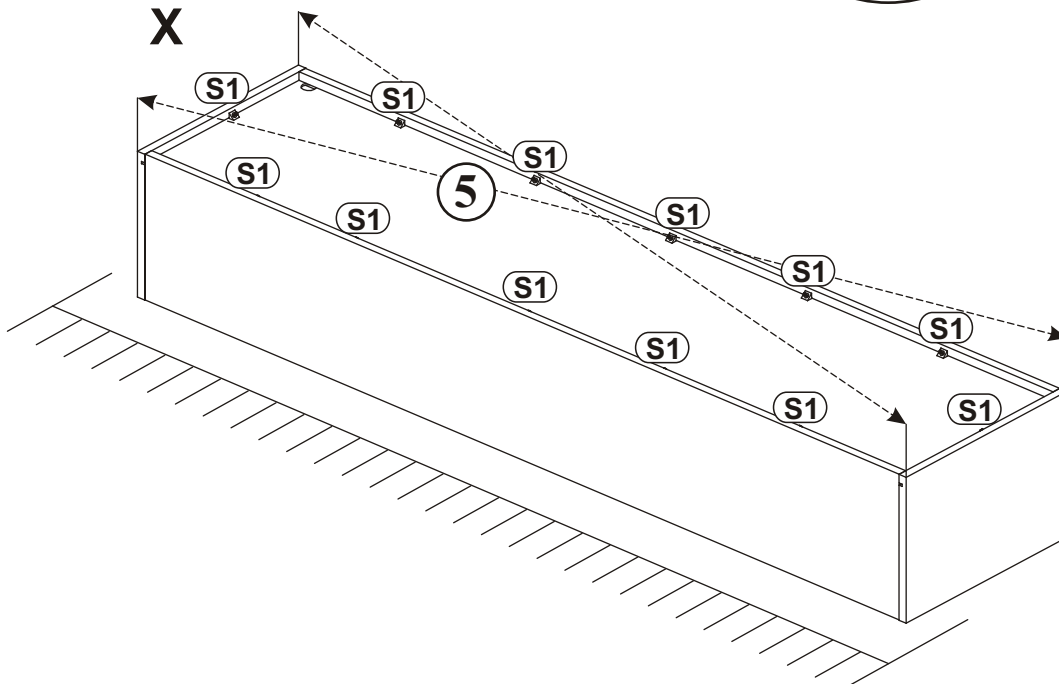

FLY TYP-40

6

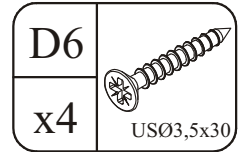
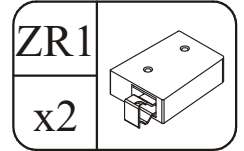
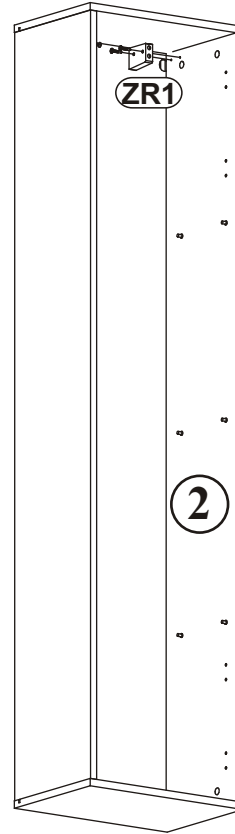
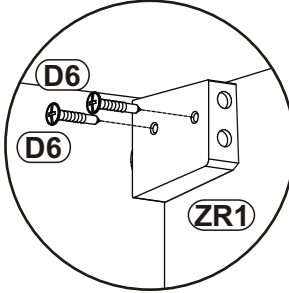
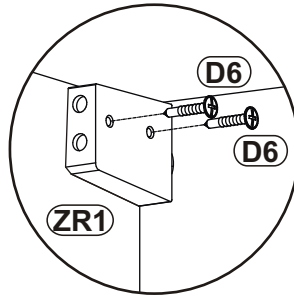
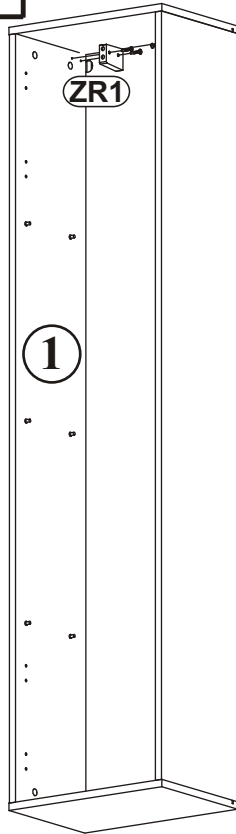

7

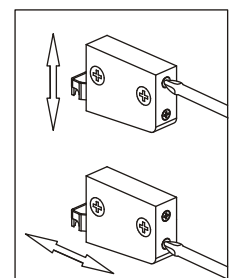
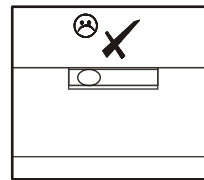
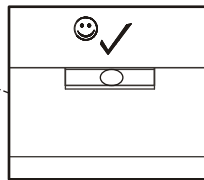
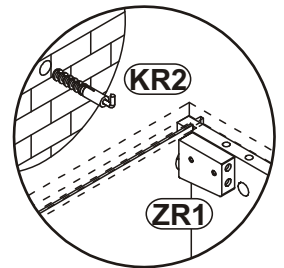
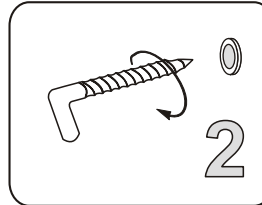
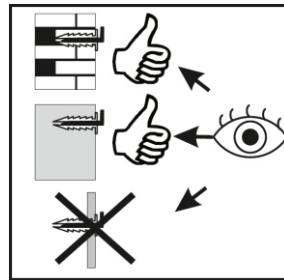
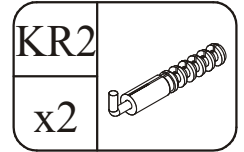
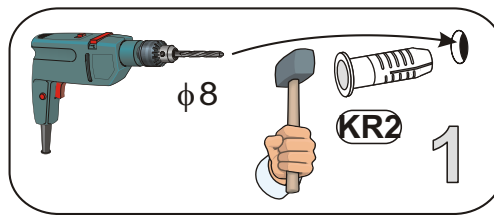
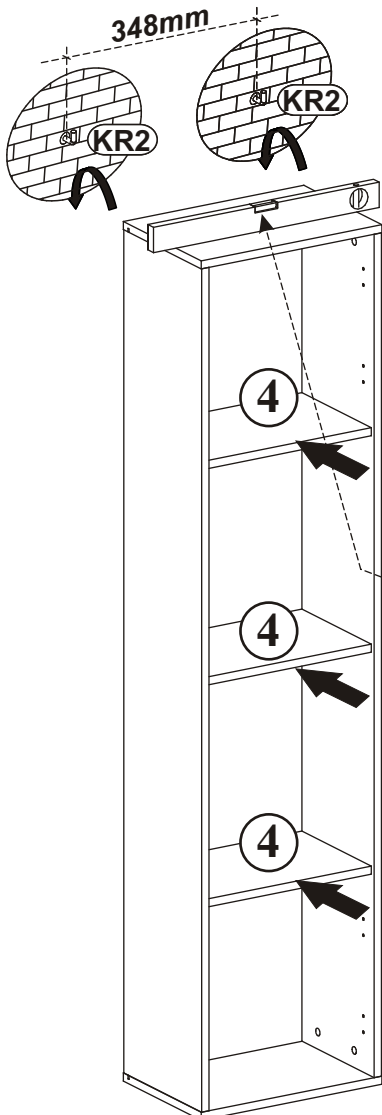

8 - 9

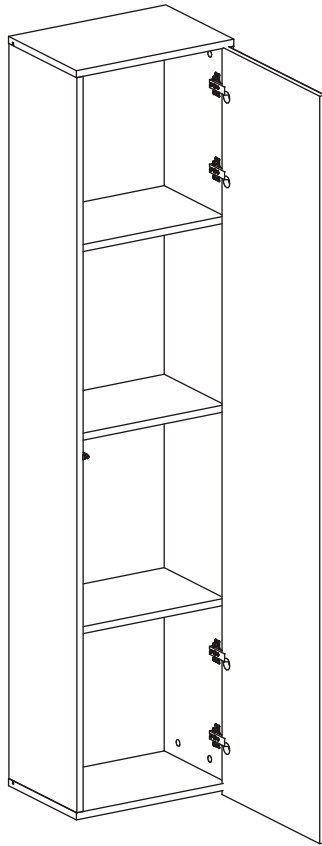

10 - 11

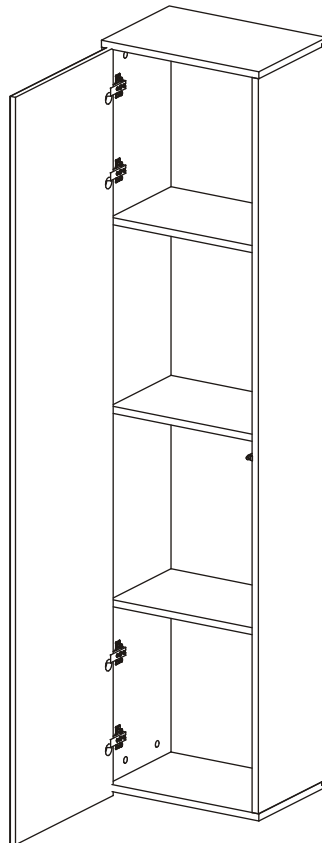

FLY TYP-40

8

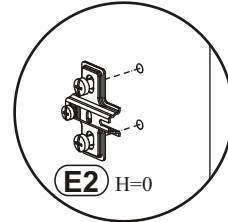
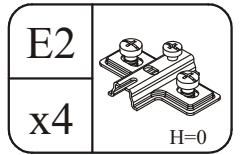
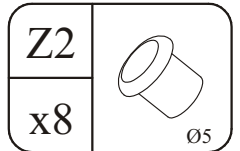
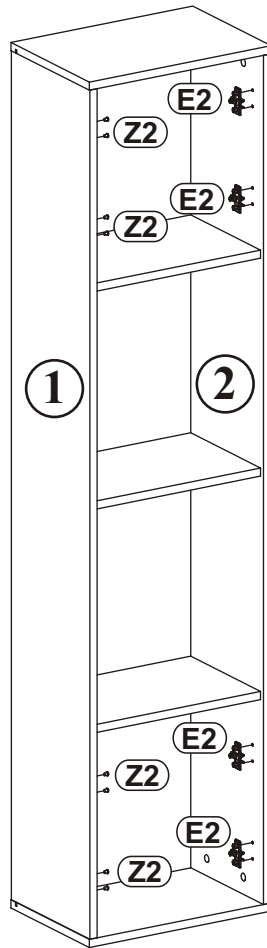
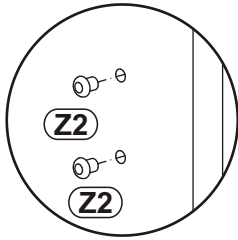
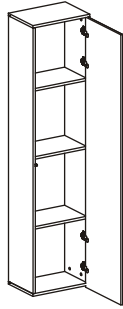

9

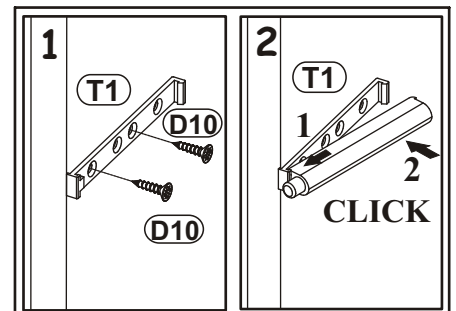
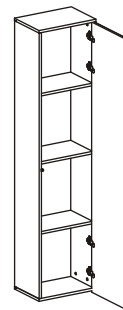
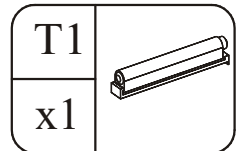
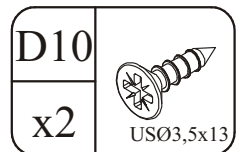
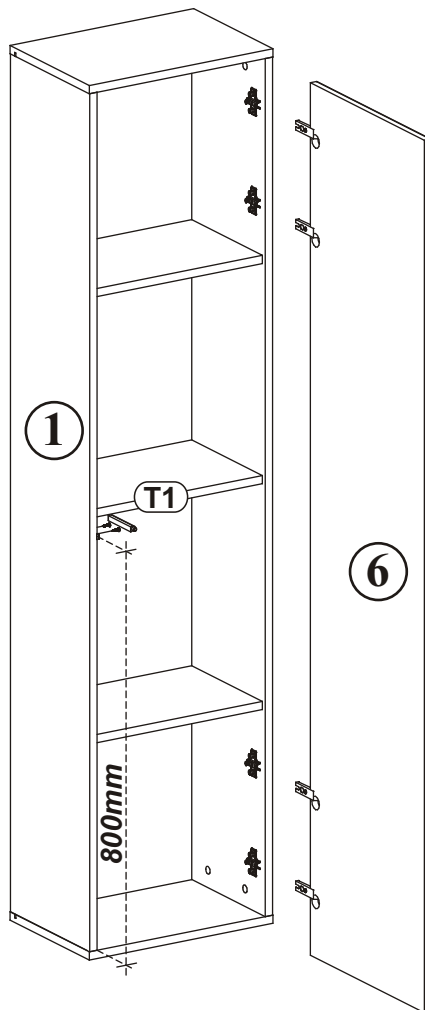
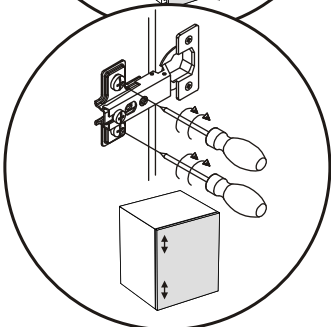
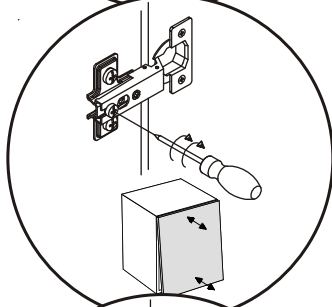
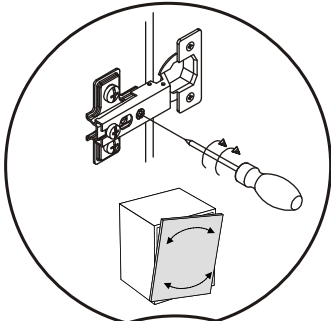

FLY TYP-40

10

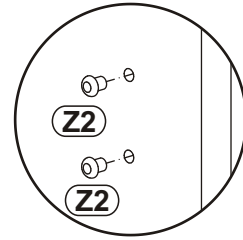
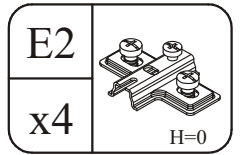
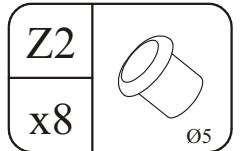
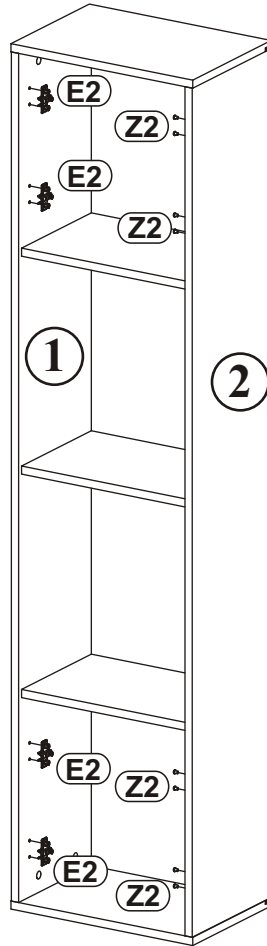
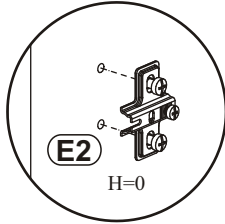
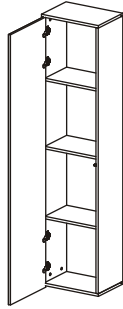

11

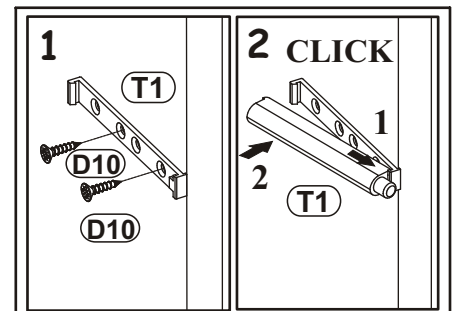
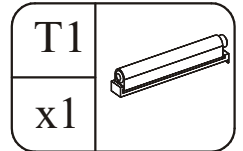
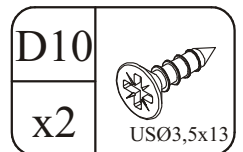
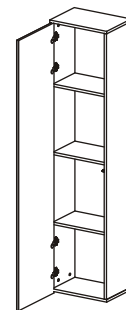
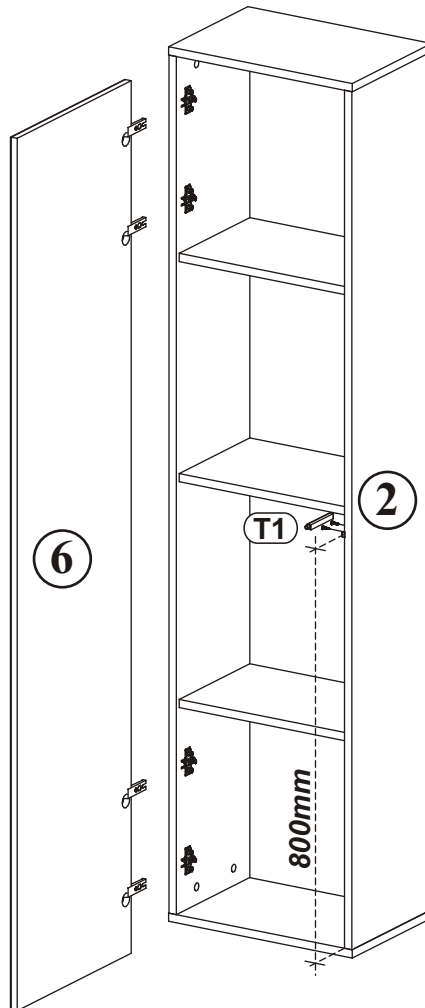
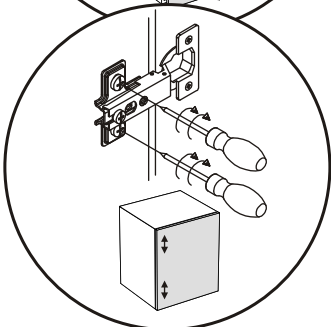
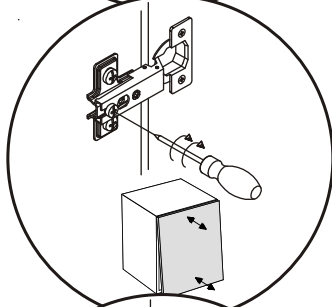
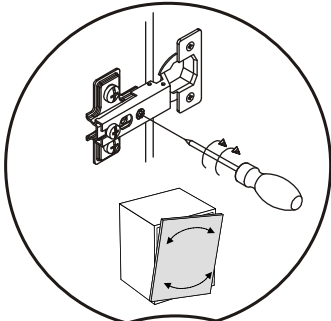



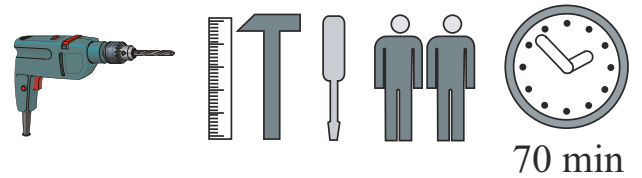
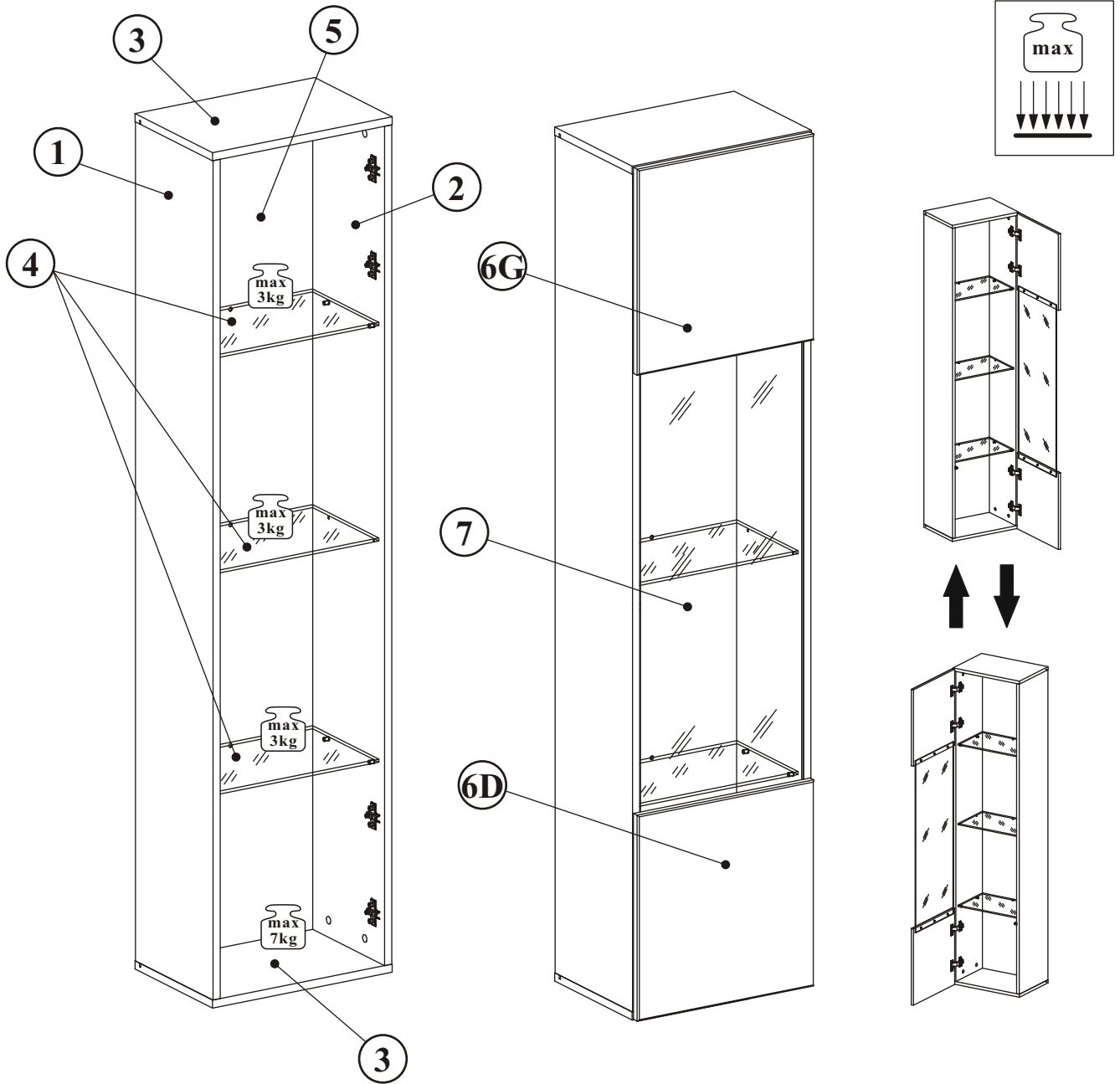





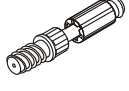

FLY TYP-42

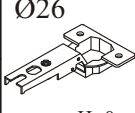
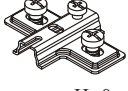
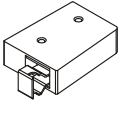

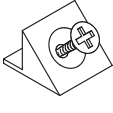
70 min

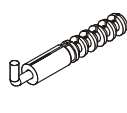
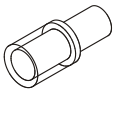
| NO | Dim. | | | Col.-No | Qty |
|----|------|-----|----|---------|-----|
| 1 | 1668 | 274 | 16 | 1 | 1 |
| 2 | 1668 | 274 | 16 | 1 | 1 |
| 3 | 400 | 274 | 16 | 1 | 2 |
| 4 | 364 | 234 | 6 | 1 | 3 |
| 5 | 1680 | 378 | 3 | 1 | 1 |
| 6G | 394 | 410 | 16 | 1 | 1 |
| 6D | 394 | 410 | 16 | 1 | 1 |
| 7 | 925 | 362 | 4 | 1 | 1 |

FLY TYP-42

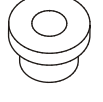
| | | | | | |
|--|--|---|---|---|--|
| A1 x8  ø8x36 | B4 x8  | B5 x8  ø15x12 | G5 x8  | E1 x4  Ø26 H=0 | E2 x4  H=0 |
| ZR1 x2  | D6 x4  USØ3,5x30 | S1 x12  | D10 x10  USØ3,5x13 | KR2 x2  | G20 x12  |
| Z2 x8  Ø5 | T1 x1  | G2 x1  | UP13 x6  UPØ3x16 | P2 x6  | |

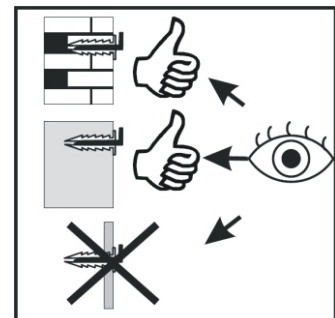
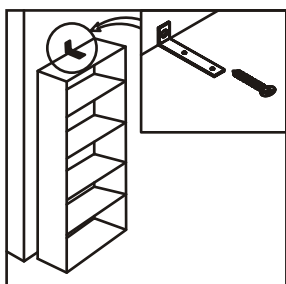
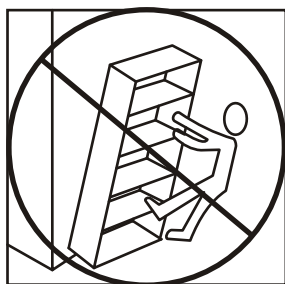
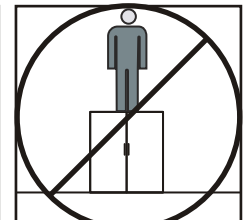
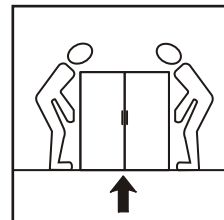
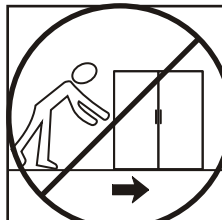
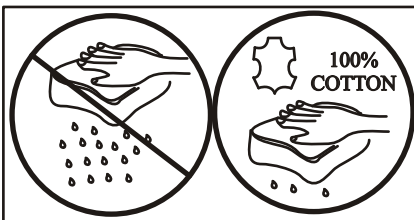
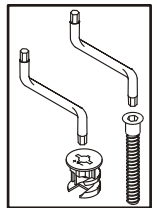
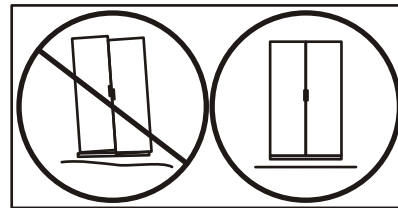
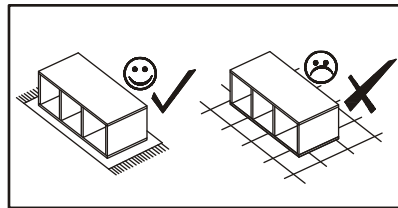
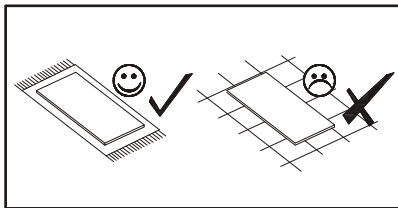
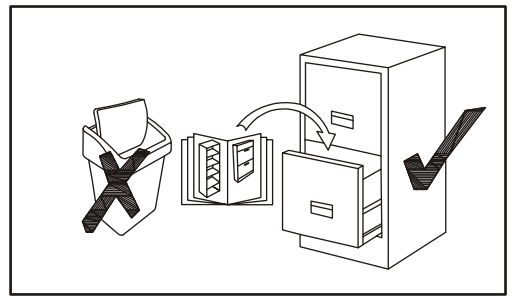
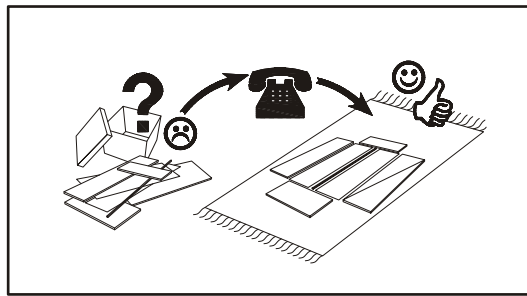
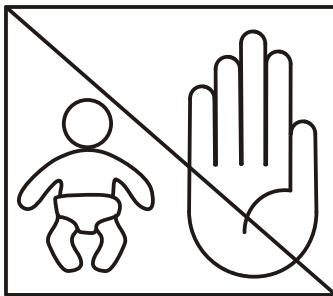
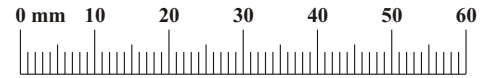

FLY TYP-42

1

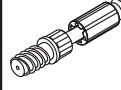
| | |
|----|--|
| B4 |  |
| x8 | |

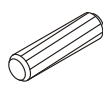
| | |
|----|---|
| A1 |  |
| x8 | ø8x36 |

| | |
|----|---|
| B5 |  |
| x8 | ø15x12 |

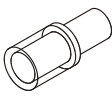

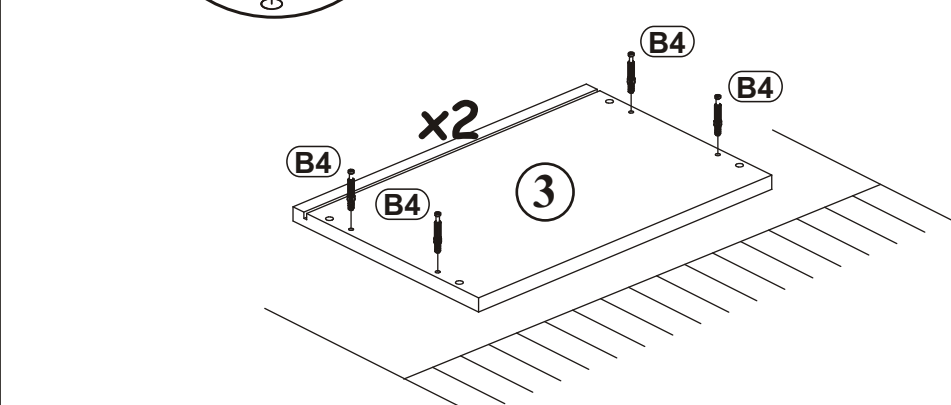
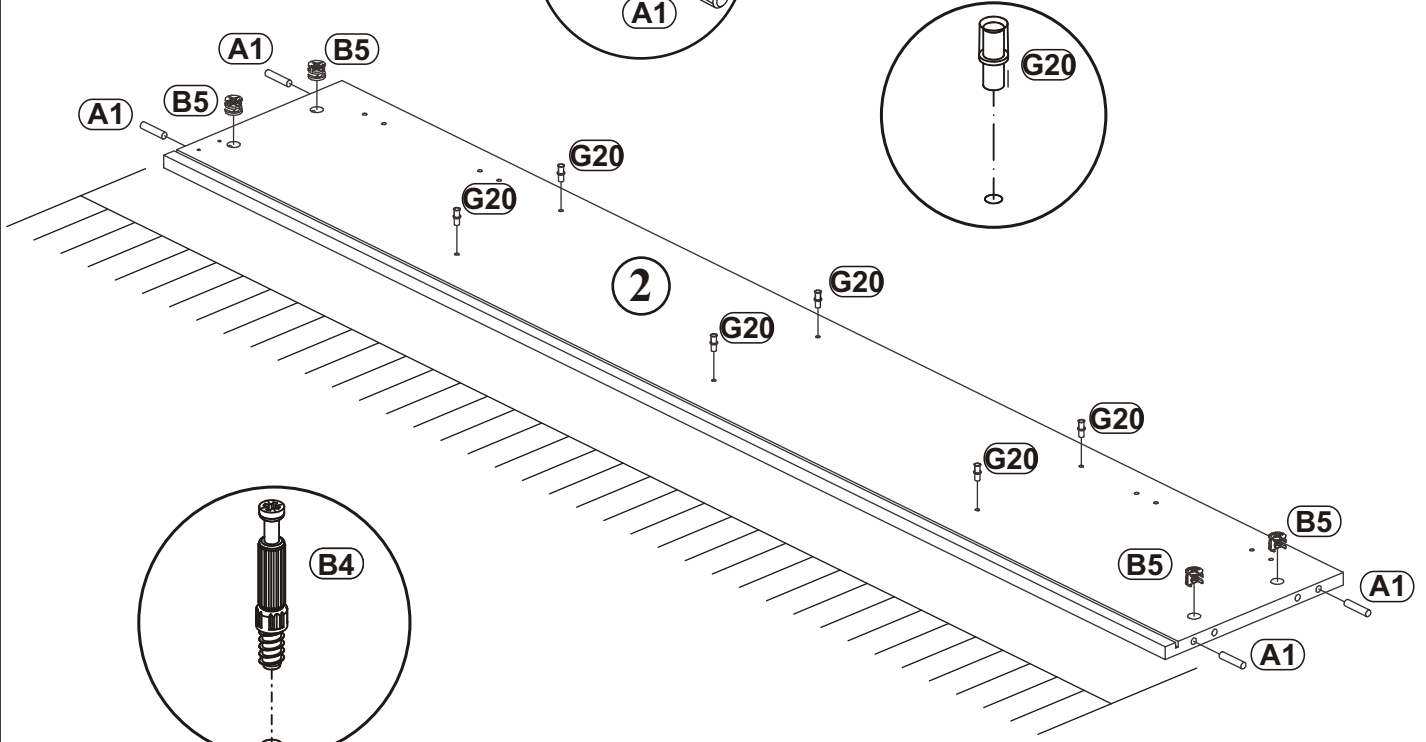
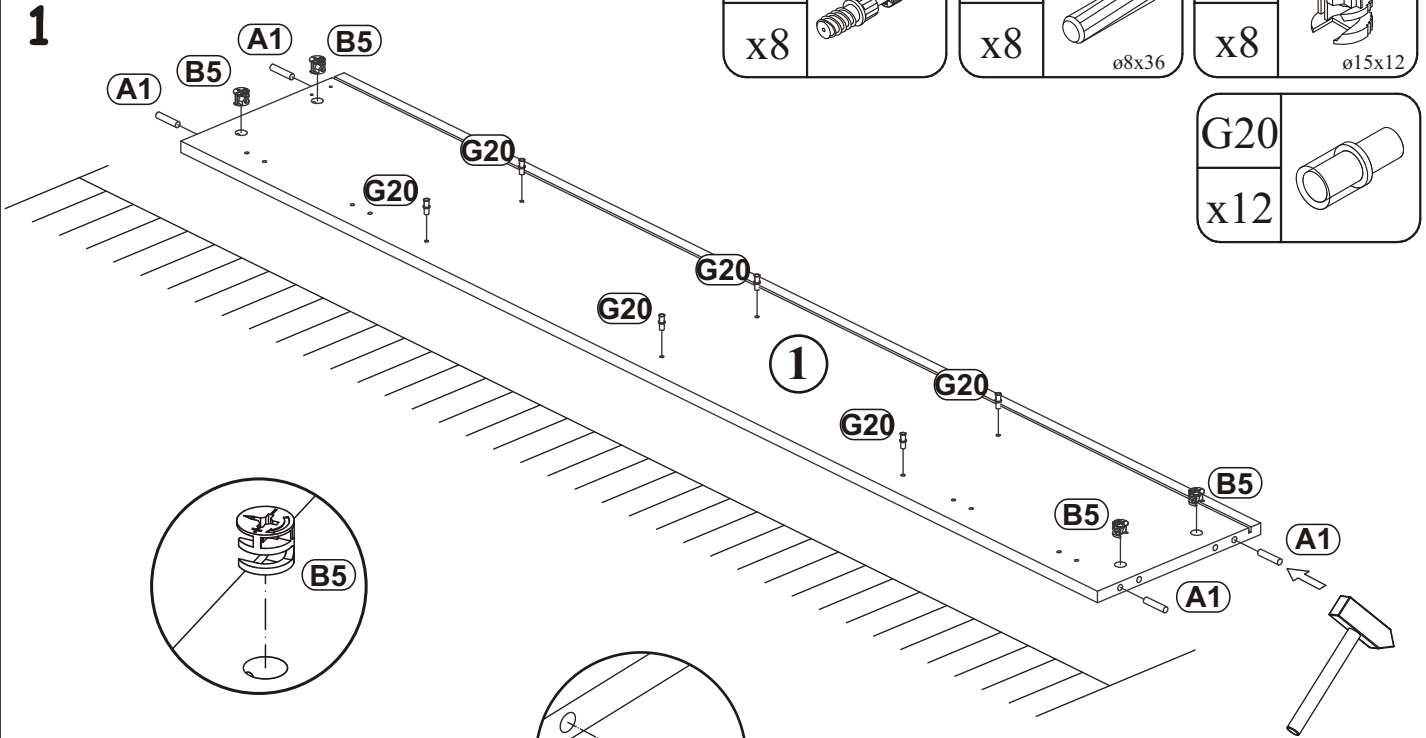
| | |
|-----|---|
| G20 |  |
| x12 | |

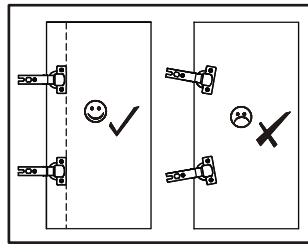
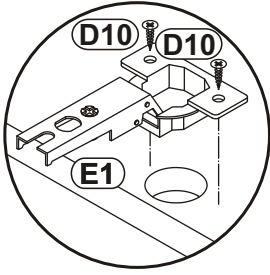

FLY TYP-42

2

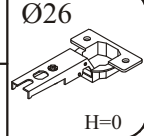

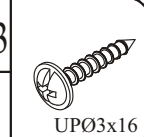
| | | | |
|-----|---|------|---|
| D10 |  | E1 |  |
| x8 | USØ3,5x13 | x4 | Ø26 H=0 |
| P2 |  | UP13 |  |
| x6 | | x6 | UPØ3x16 |

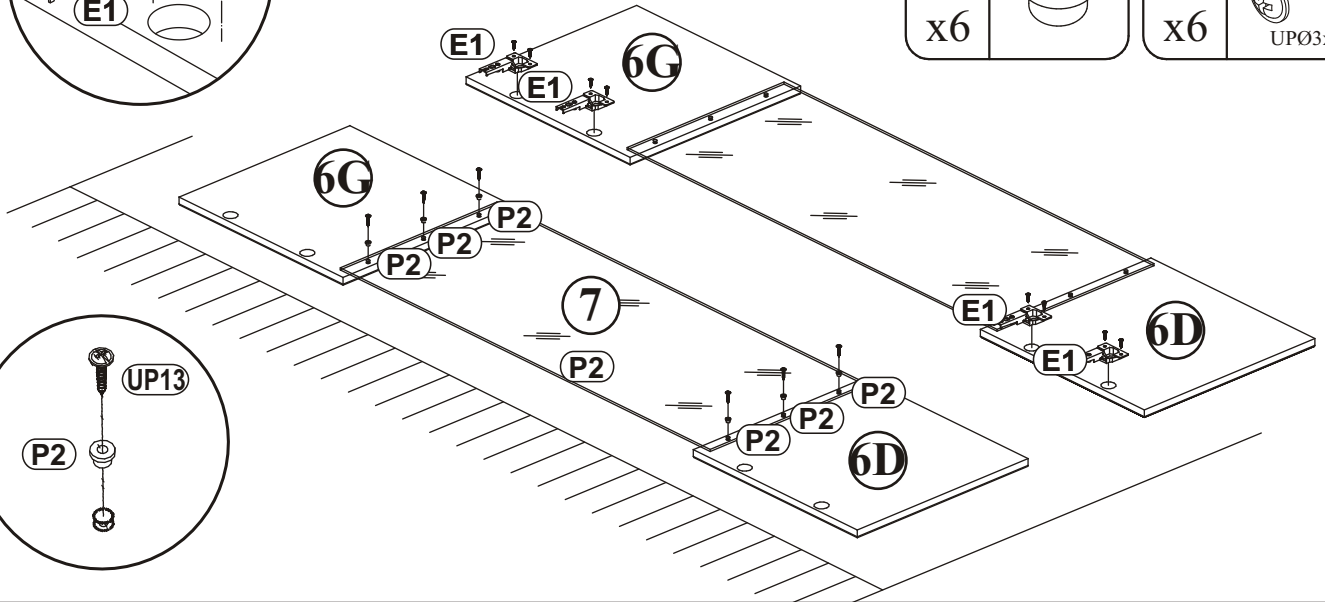
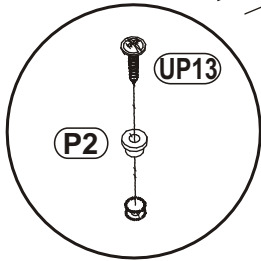

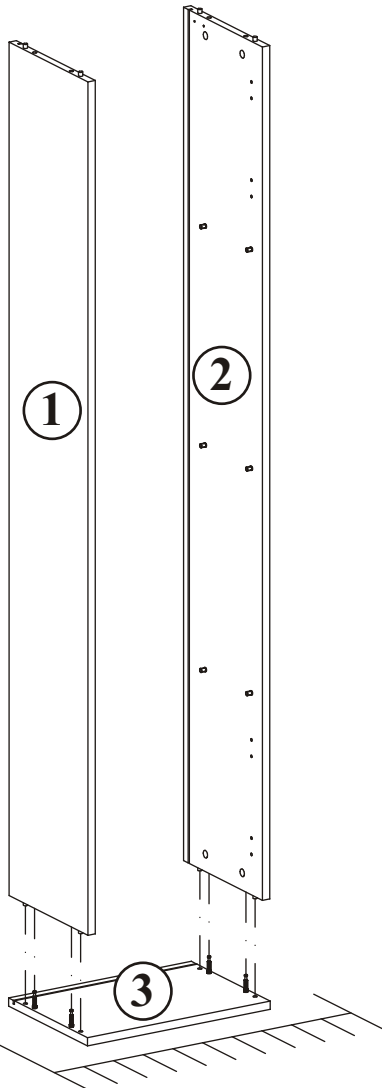

3

a)

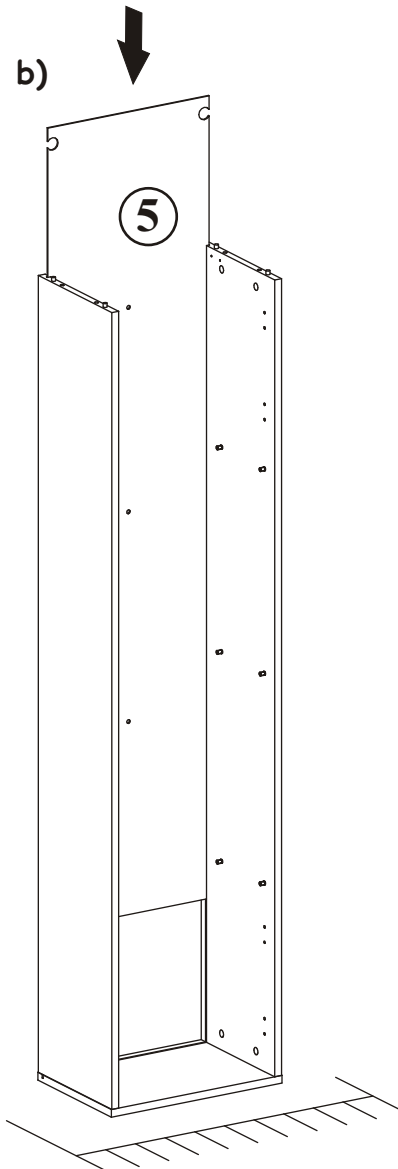

b)



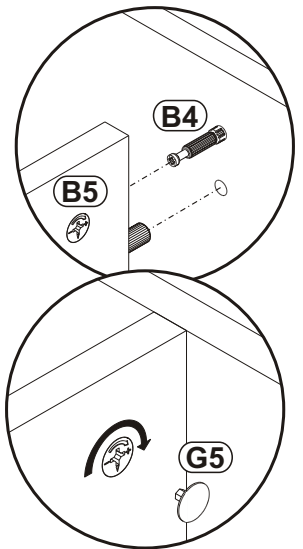

| | |
|----|--|
| G5 |  |
| x4 | |

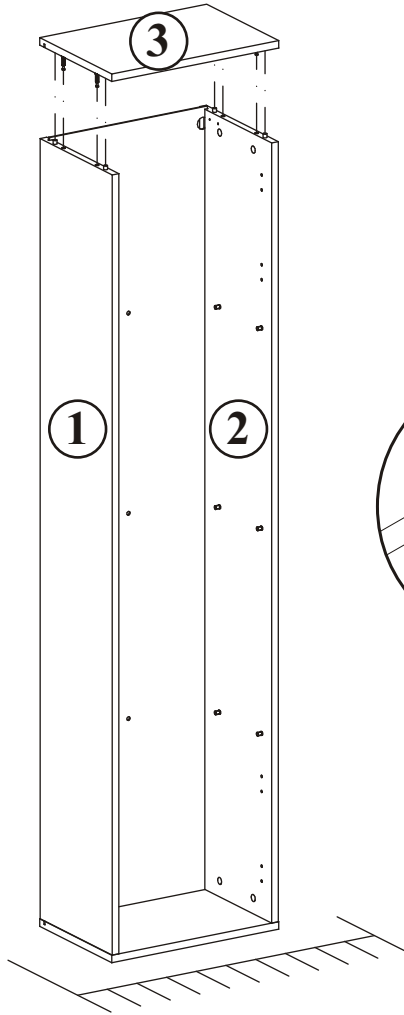

FLY TYP-42

4



| | |
|----|---|
| G5 |  |
| x4 | |

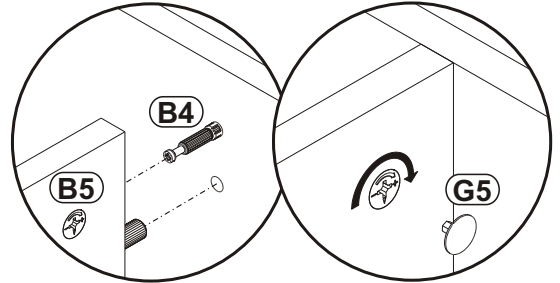

5



Y

X

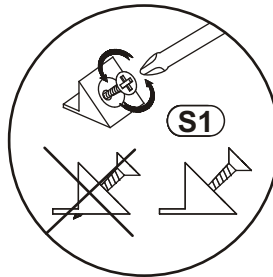
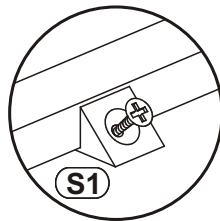

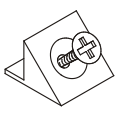
| | |
|-----|---|
| S1 |  |
| x12 | |

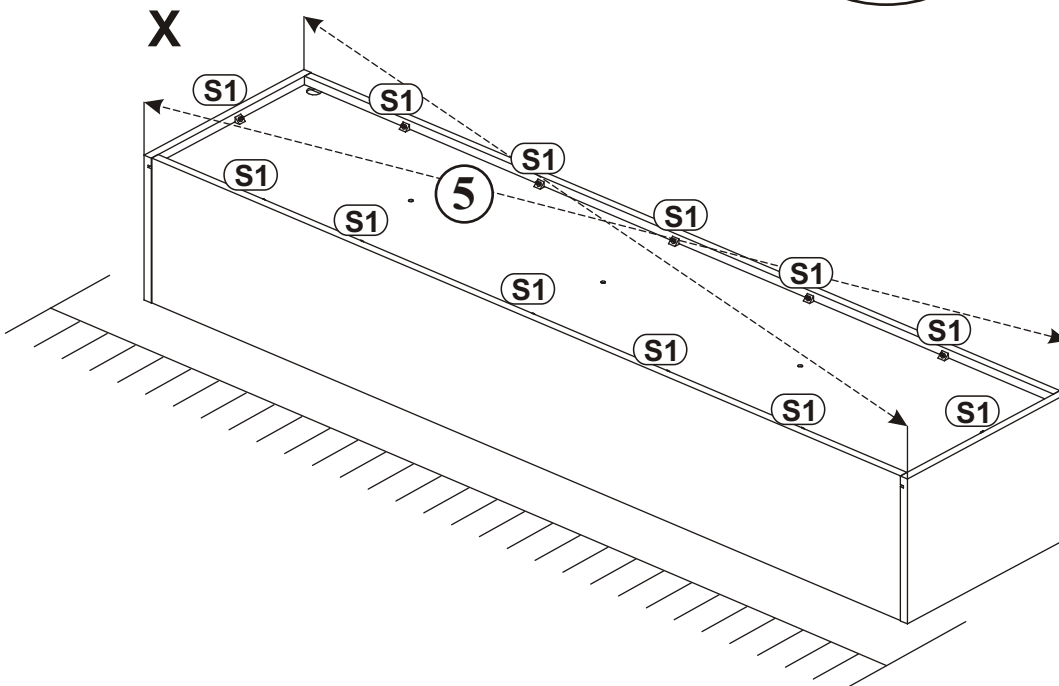

6

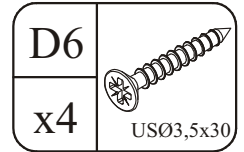
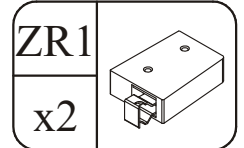
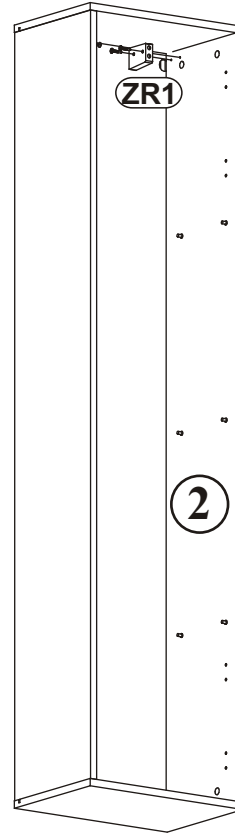
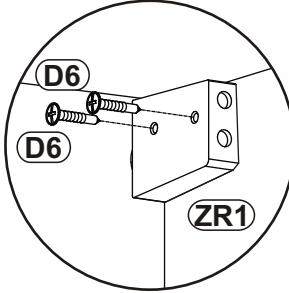
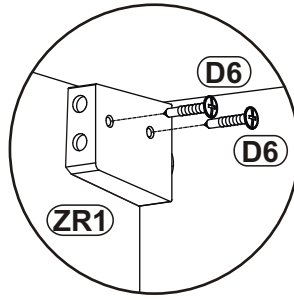
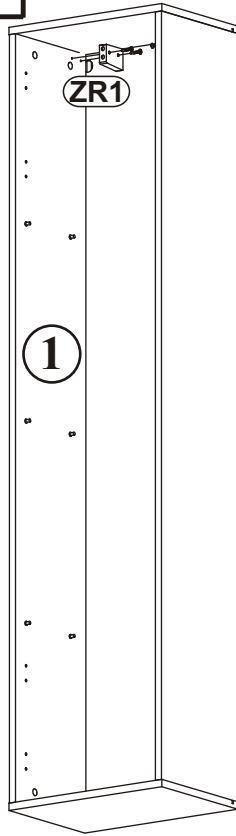

7

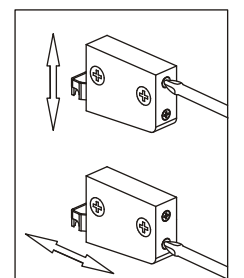
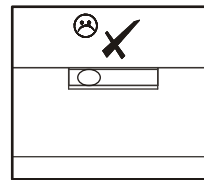
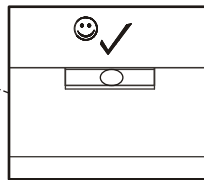
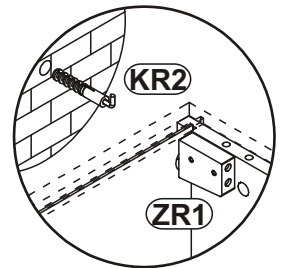
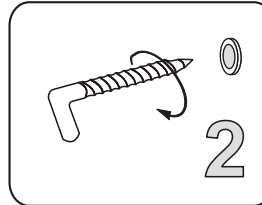
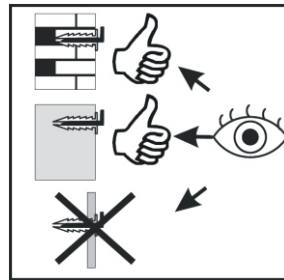
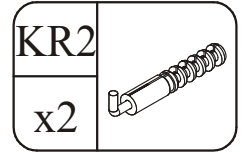
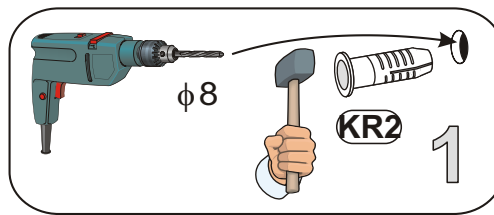
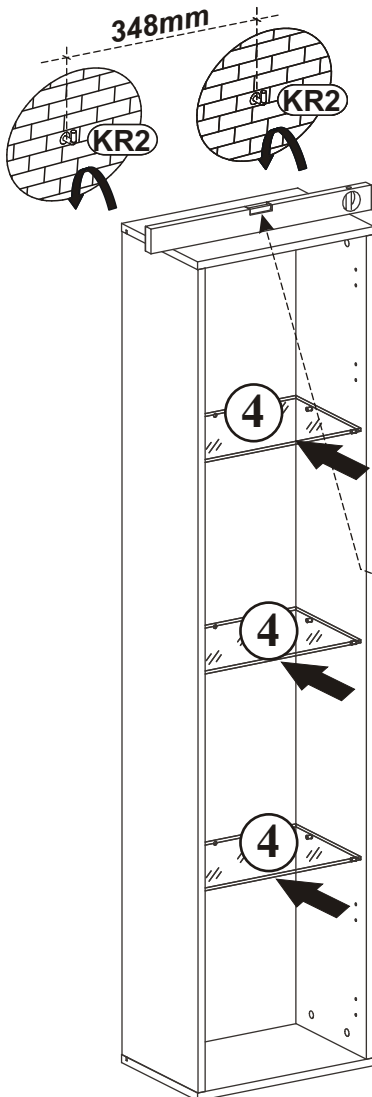

8 - 9

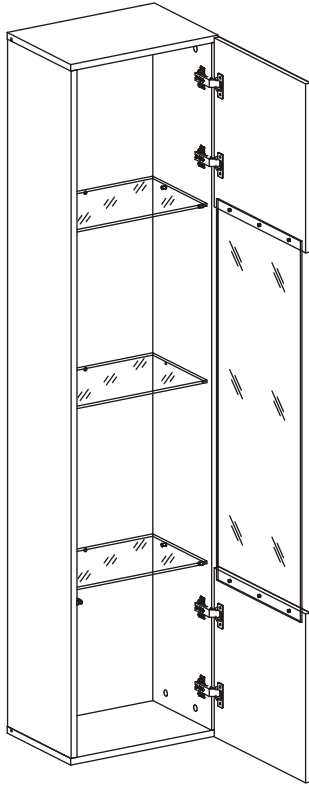

10 - 11

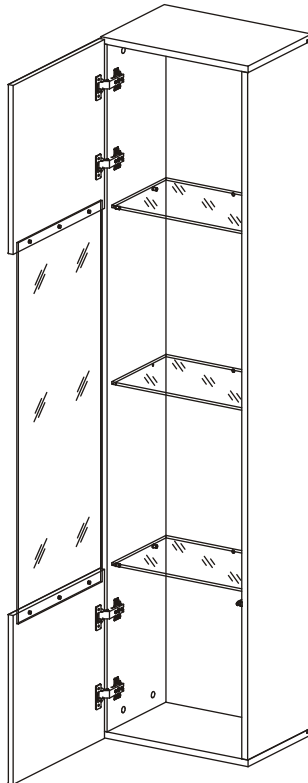

FLY TYP-42

8

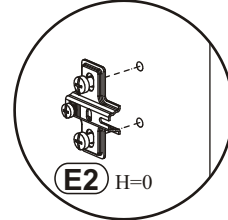
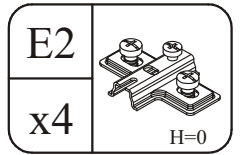
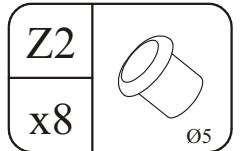
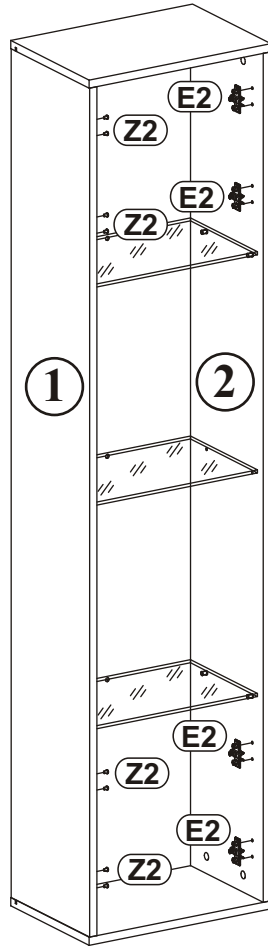
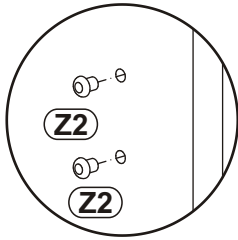
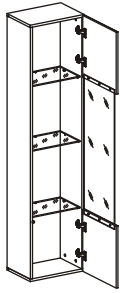

9

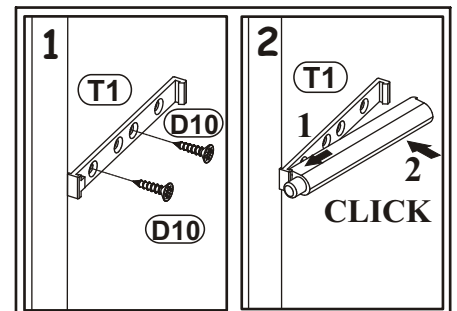
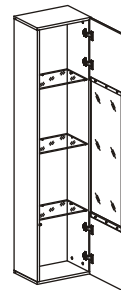
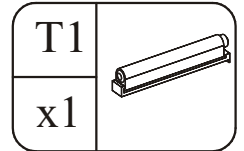
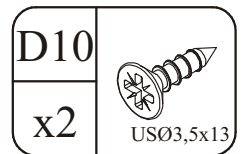
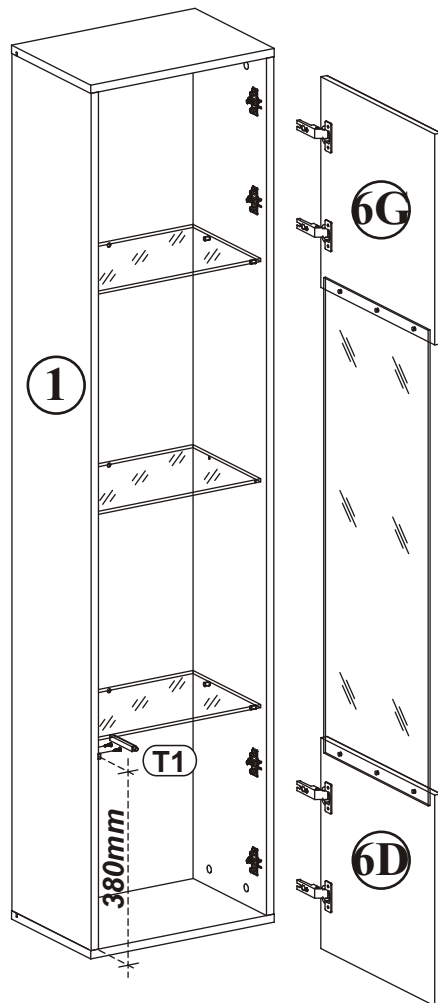
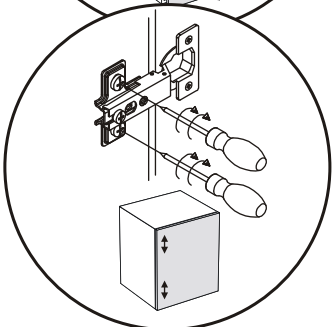
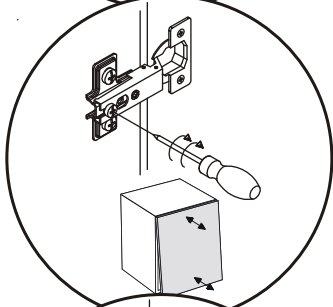
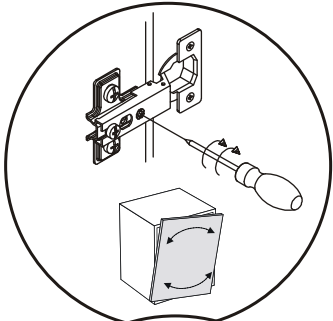

FLY TYP-42

10

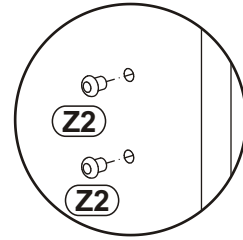
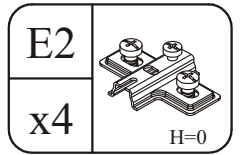
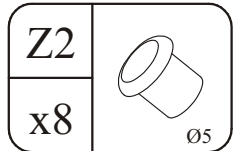
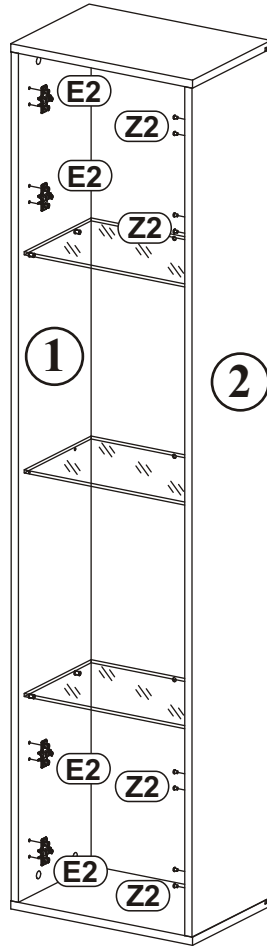
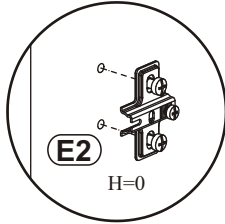
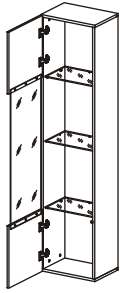

11

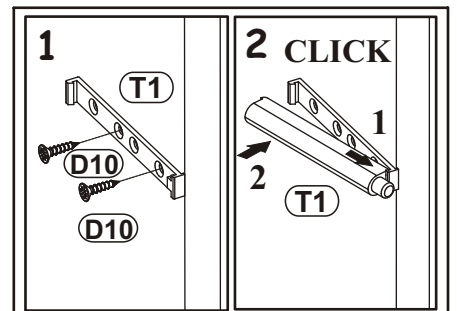
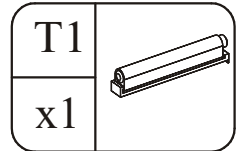
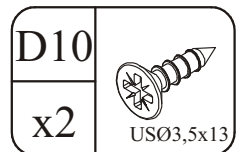
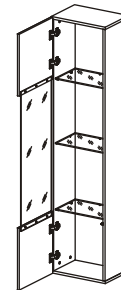
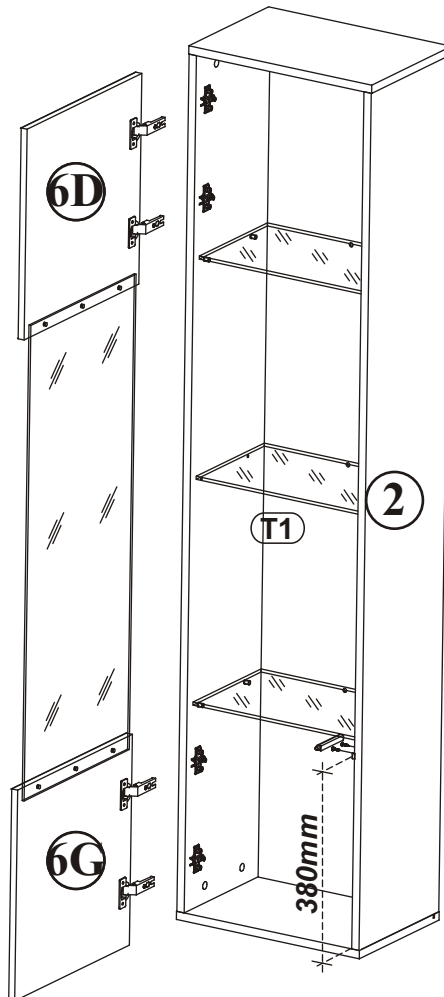
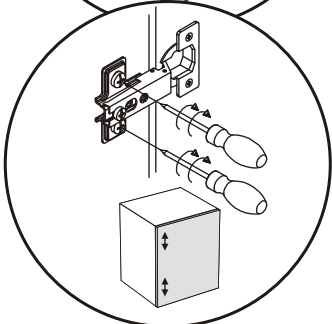
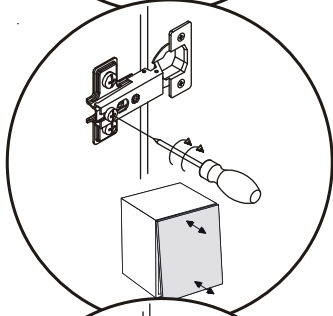
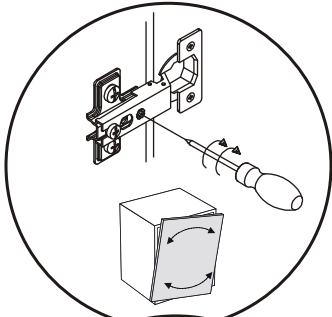



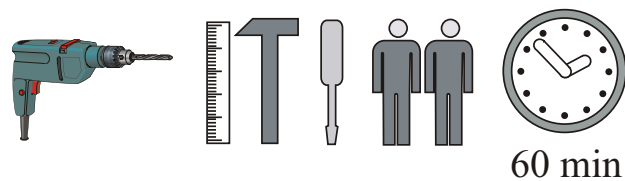
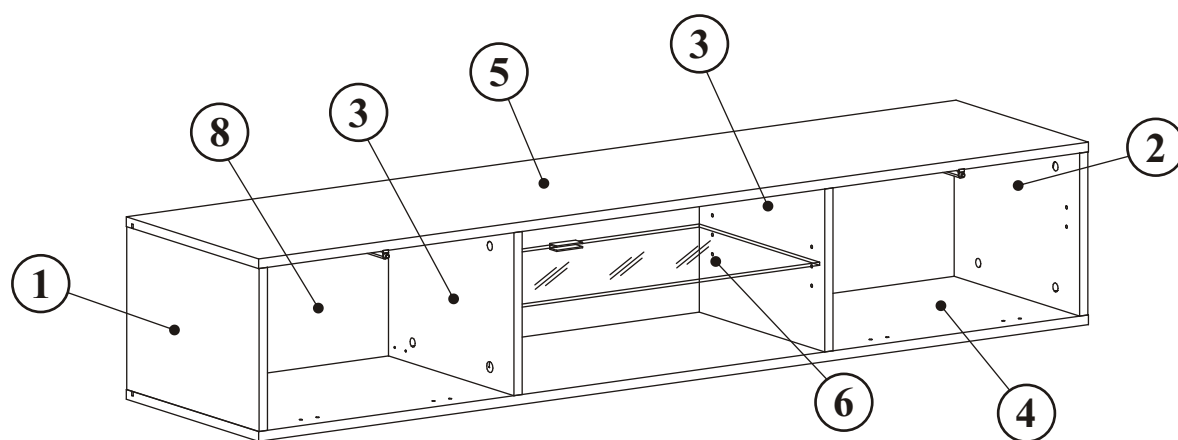
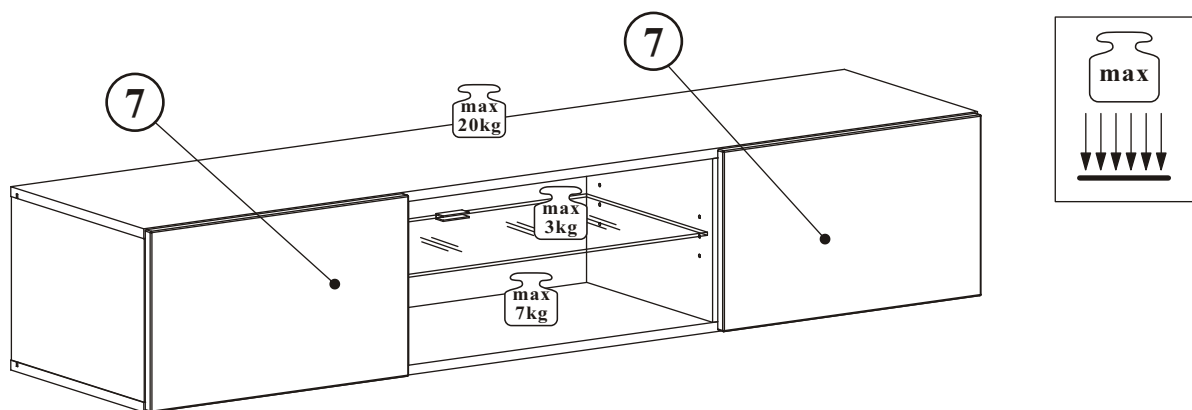





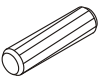
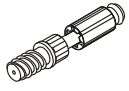

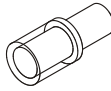

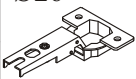
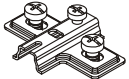
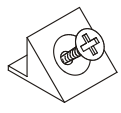
FLY TYP-33



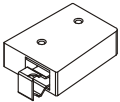

| NO | Dim. | | | Col.-No | Qty |
|----|------|-----|----|---------|-----|
| 1 | 268 | 384 | 16 | 1 | 1 |
| 2 | 268 | 384 | 16 | 1 | 1 |
| 3 | 268 | 364 | 16 | 1 | 2 |
| 4 | 1602 | 384 | 16 | 1 | 1 |
| 5 | 1602 | 384 | 16 | 1 | 1 |
| 6 | 582 | 349 | 6 | 1 | 1 |
| 7 | 496 | 296 | 16 | 1 | 2 |
| 8 | 1580 | 280 | 3 | 1 | 1 |

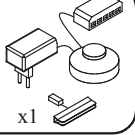
FLY TYP-33

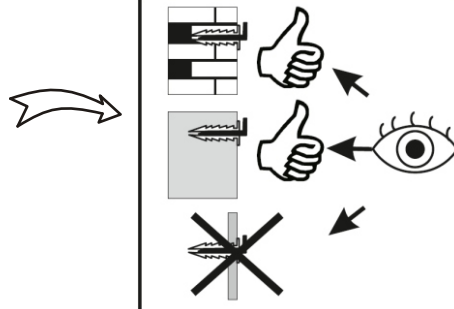
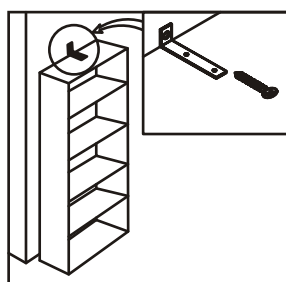
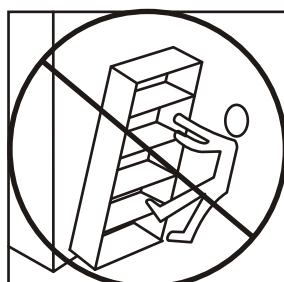
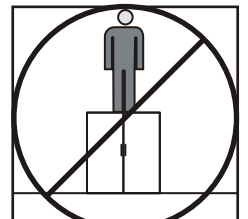
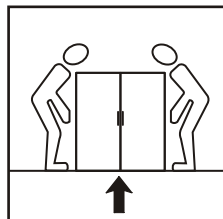
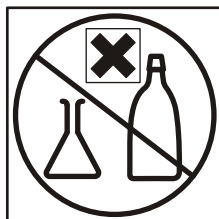
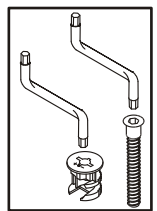
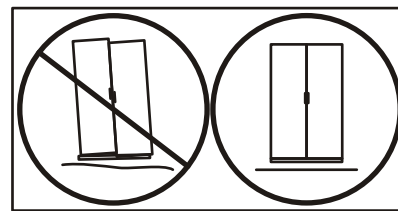
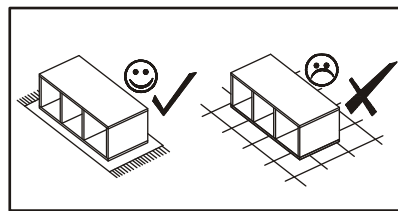
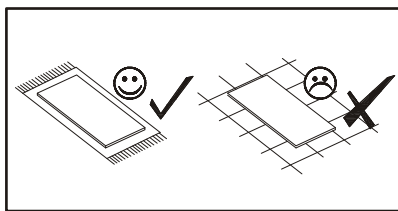
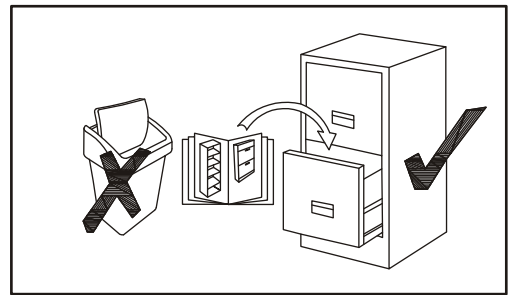
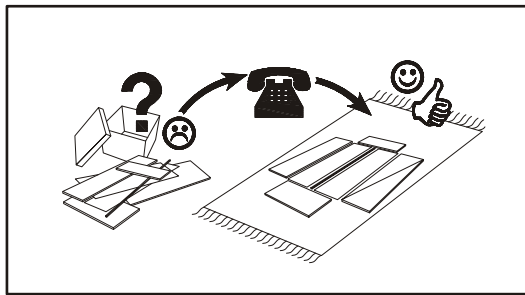
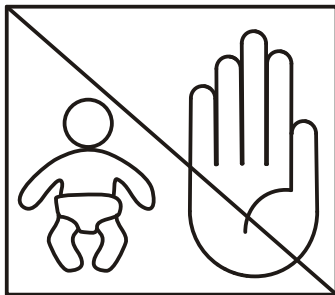
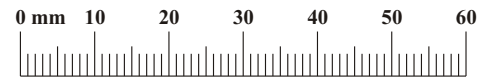
| | | | | | |
|---|--|--|---|--|--|
| A1 x16  ø8x36 | B4 x16  | B5 x16  ø15x12 | G5 x16  | G20 x4  | G2 x1  |
| E1 x4 Ø26 H=0  | E2 x4 H=0  | S1 x12  | D6 x8 USØ3,5x30  | D10 x16 USØ3,5x13  | G21 x2  |
| ZR1 x4  | KR2 x4  | D7 x6 USØ3x16  | T1 x2  | LED x1 x1  | |

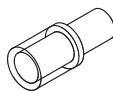
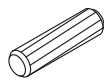

FLY TYP-33

| | | | | | |
|-----|--|-----|---|-----|---|
| G20 |  | A1 |  | B5 |  |
| x4 | | x16 | ø8x36 | x16 | ø15x12 |

1

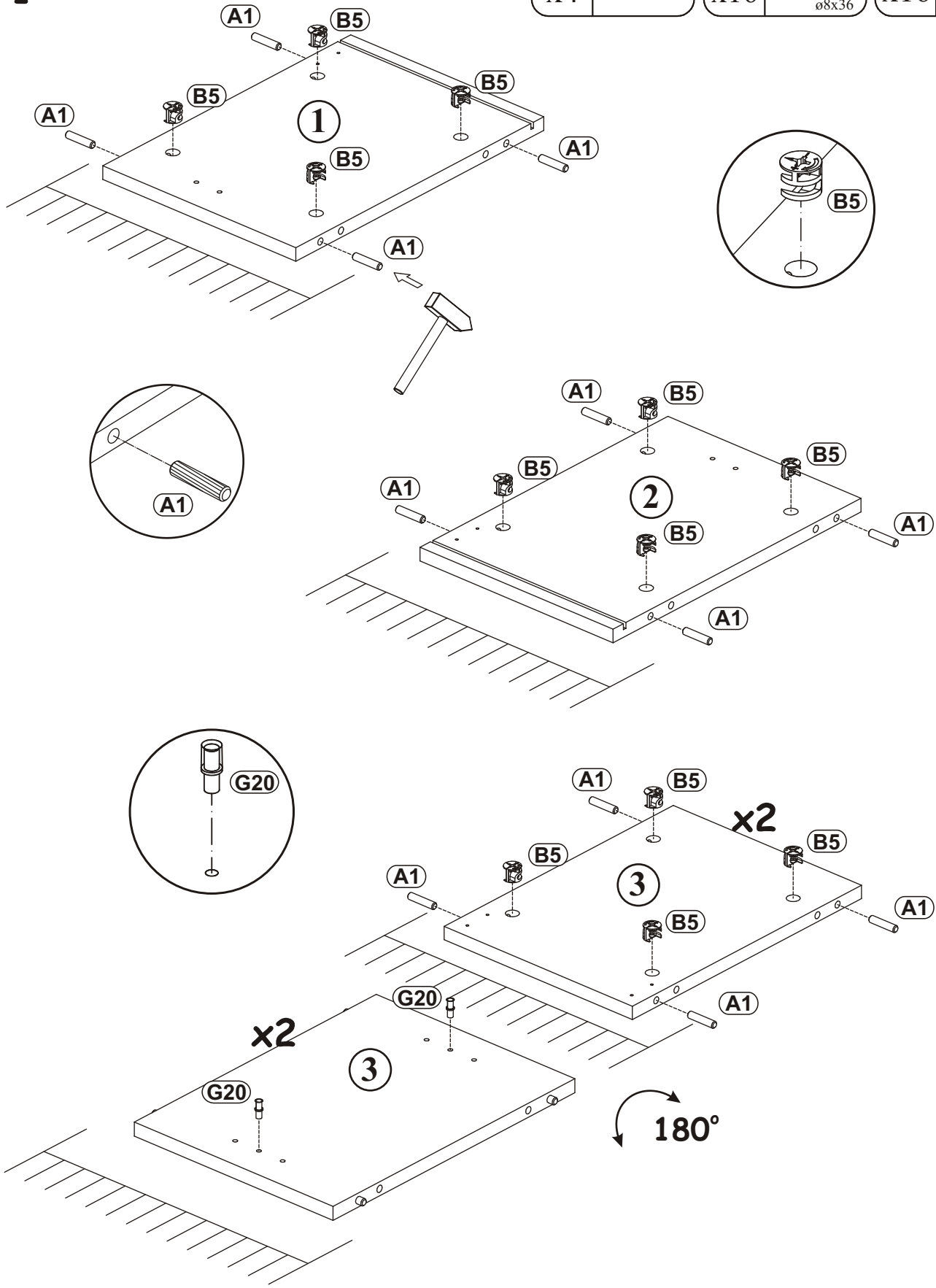

FLY TYP-33

2

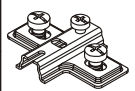
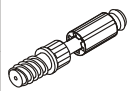
| | | | |
|----|---|-----|---|
| E2 |  | B4 |  |
| x4 | H=0 | x16 | |

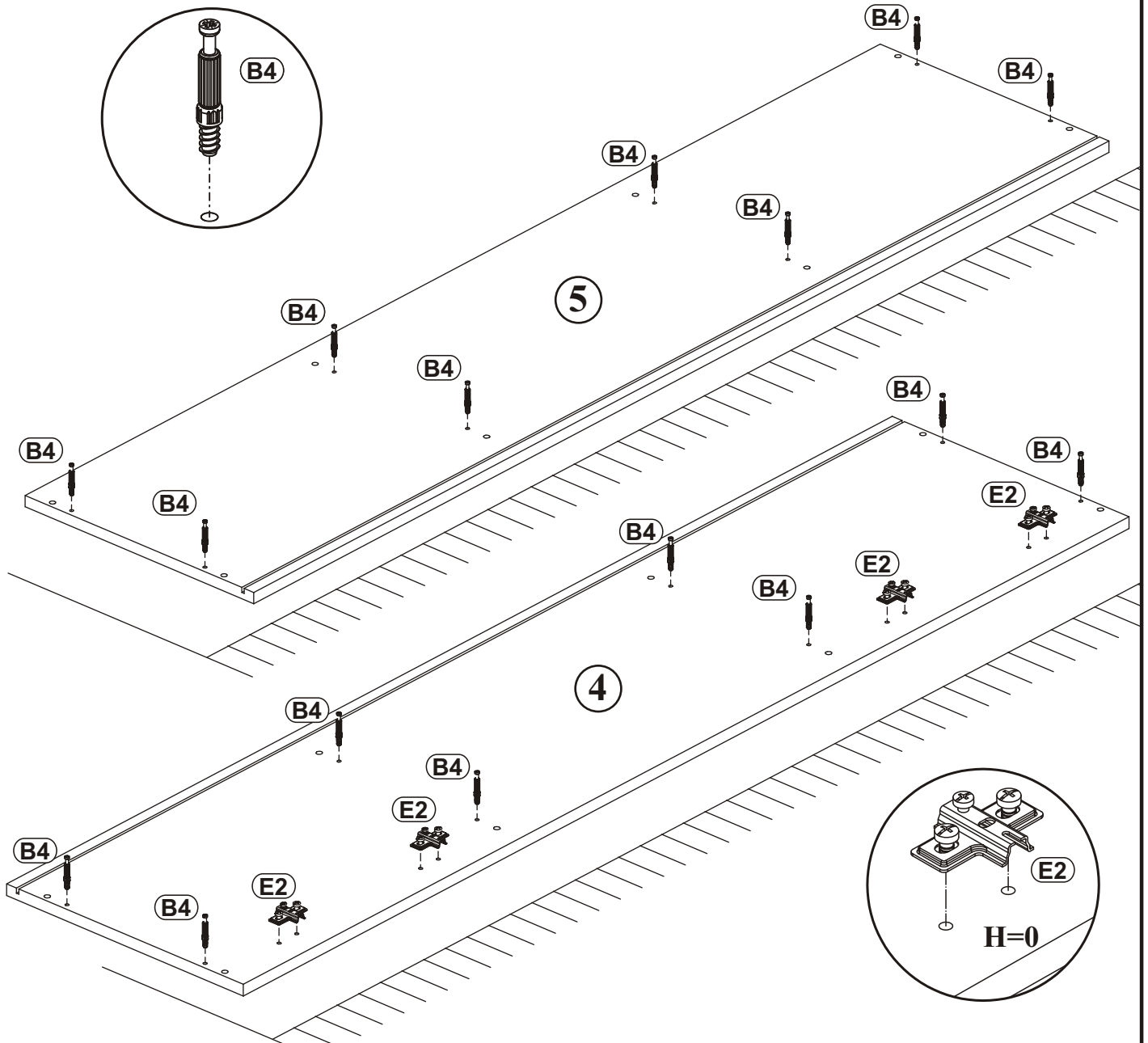

3

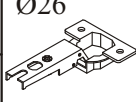
| | | | |
|-----|---|----|---|
| D10 |  | E1 |  |
| x8 | USØ3,5x13 | x4 | Ø26 H=0 |

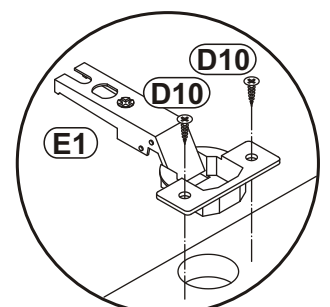
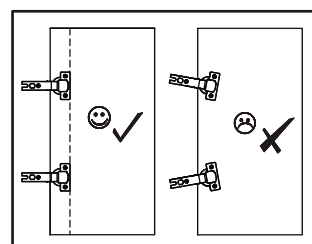
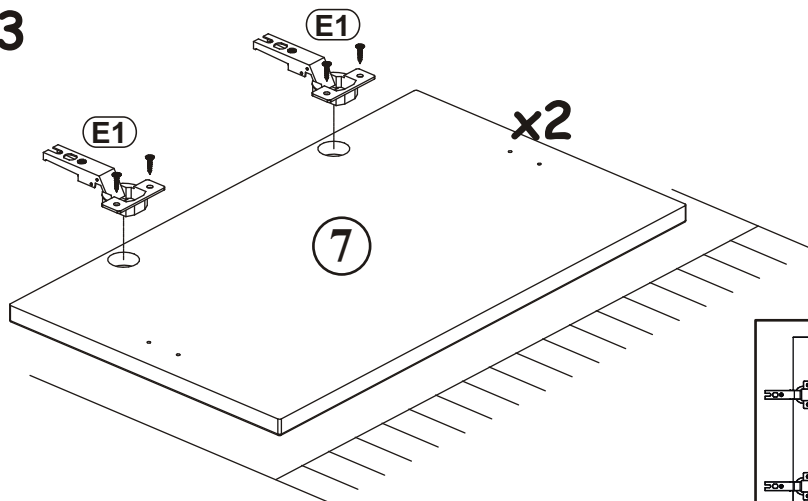

4

a)

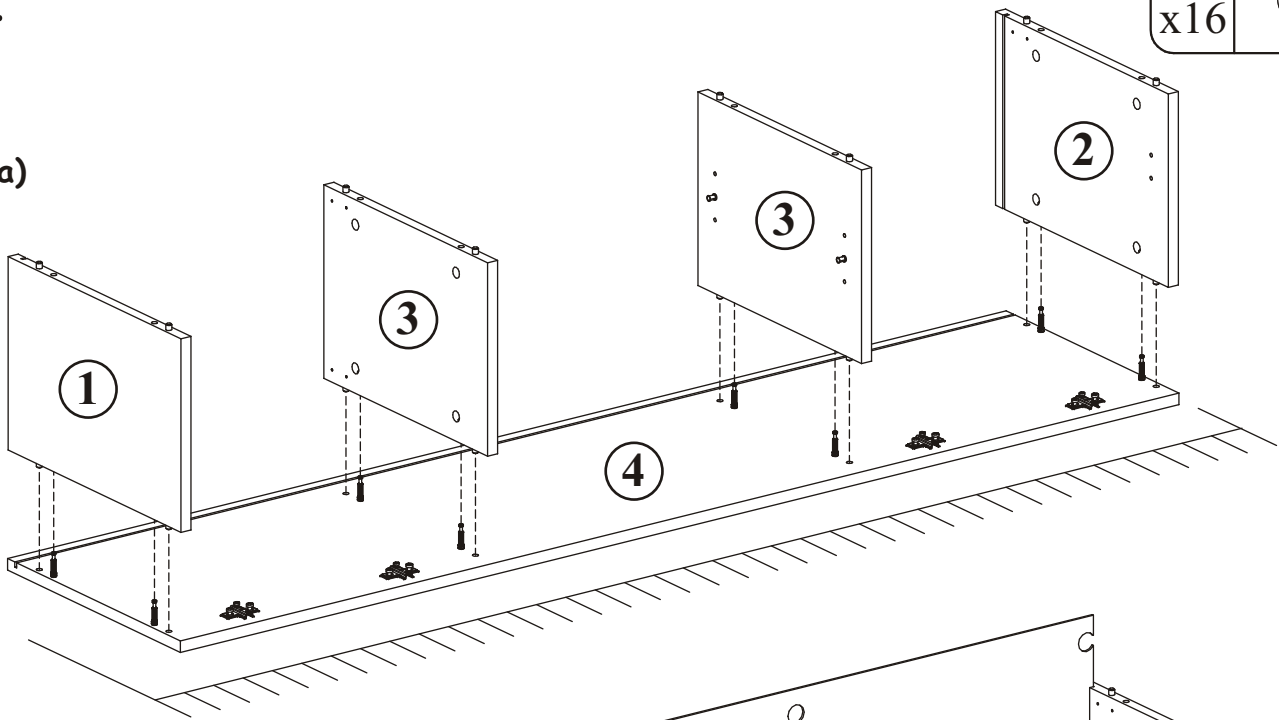

b)

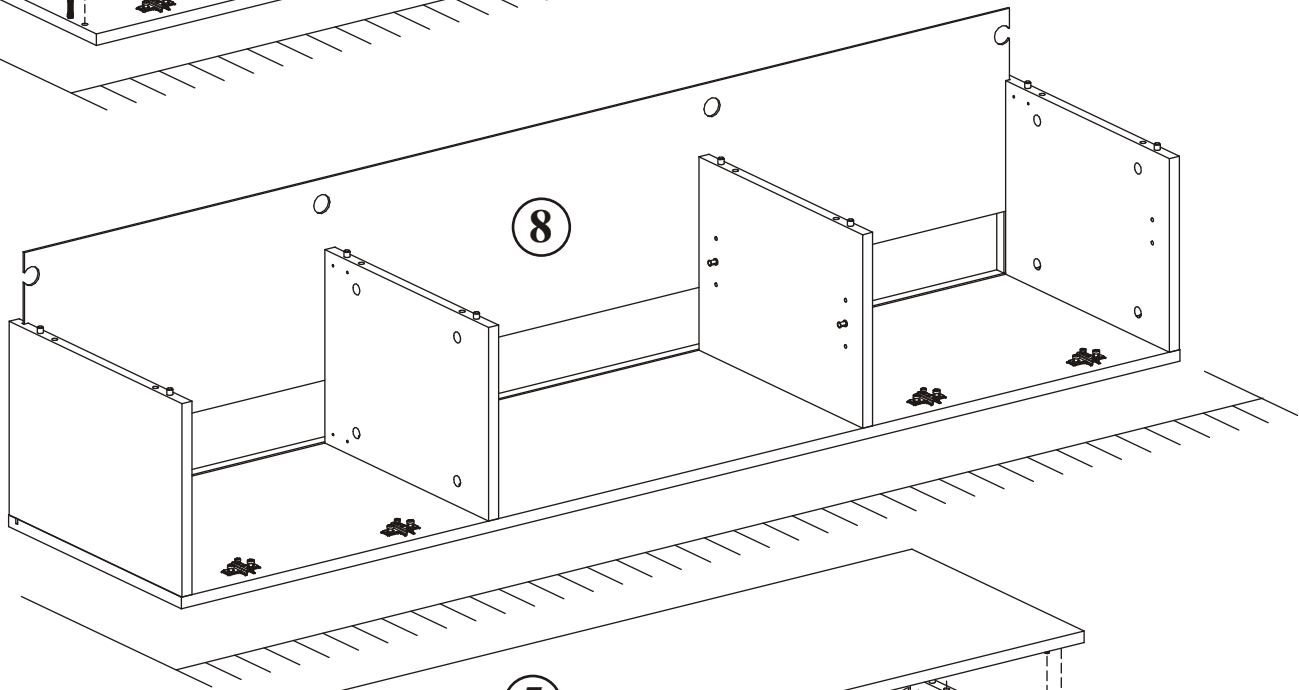

c)

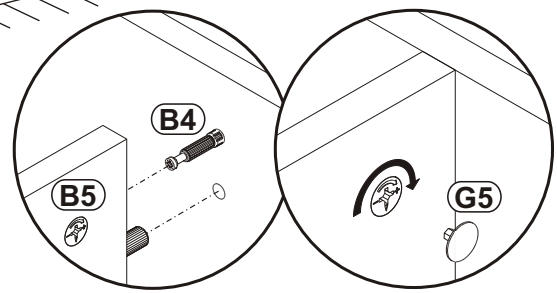
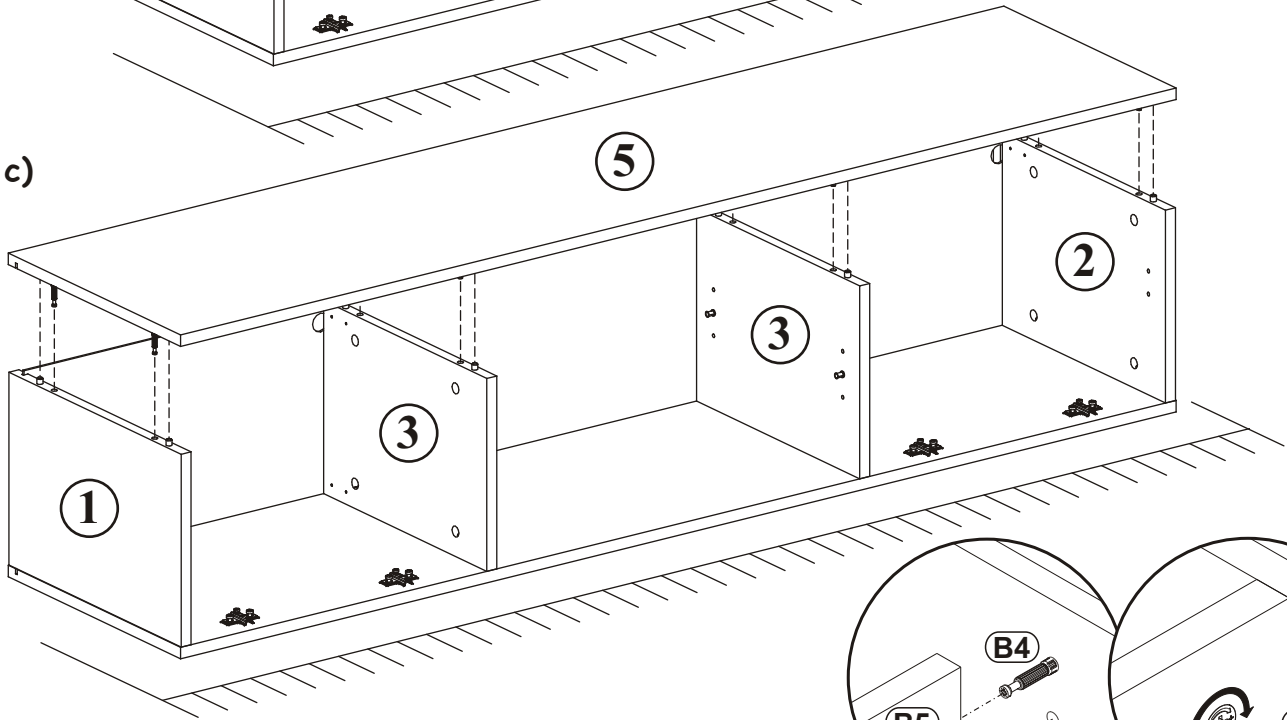

5

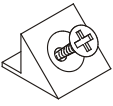
| | |
|-----|---|
| S1 |  |
| x12 | |

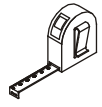

$X=Y$ 90°

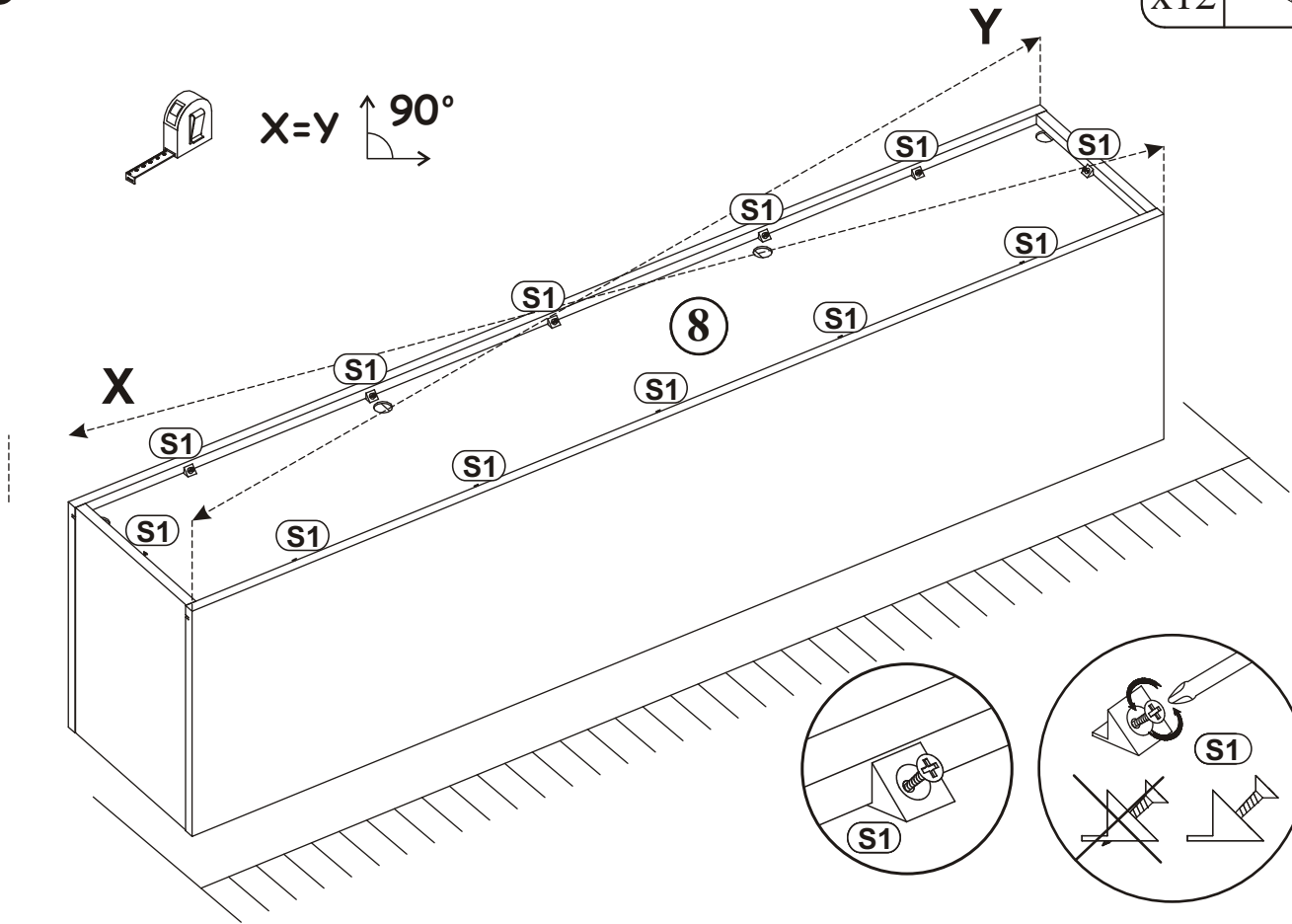

6

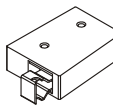
| | |
|-----|---|
| ZR1 |  |
| x4 | |

| | |
|----|---|
| D6 |  |
| x8 | USØ3,5x30 |

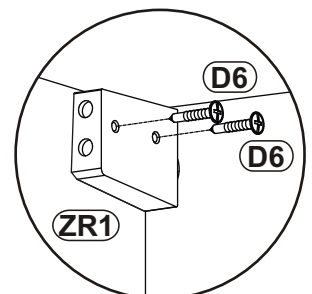
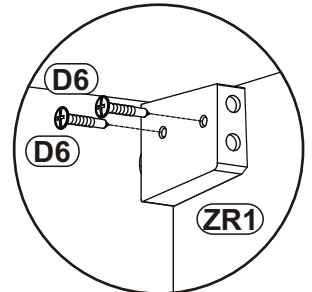
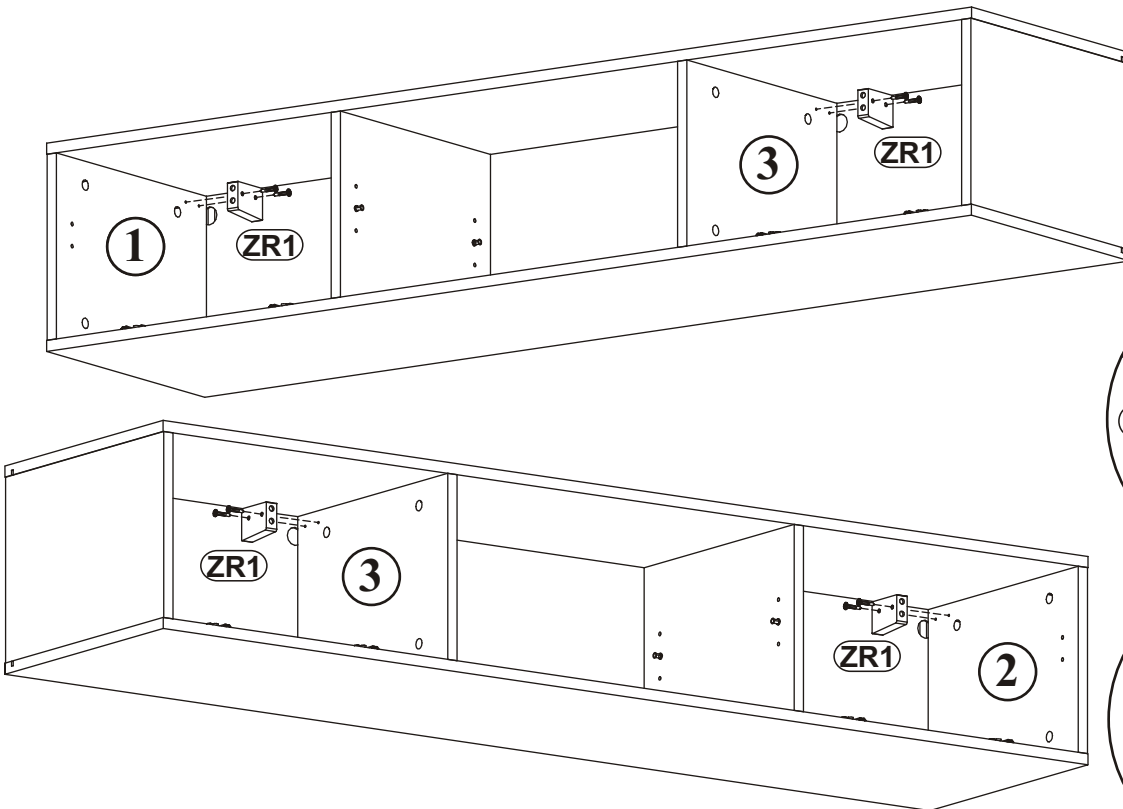

FLY TYP-33

7

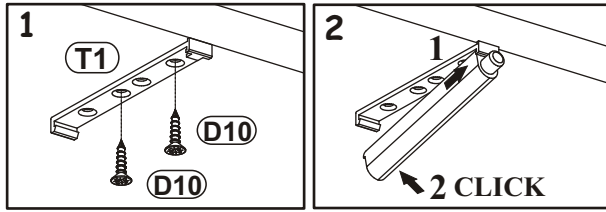

| | | | | | |
|----|--|-----|----|-----|-----------|
| T1 | | LED | | D10 | |
| x2 | | x1 | x1 | x4 | USØ3,5x13 |

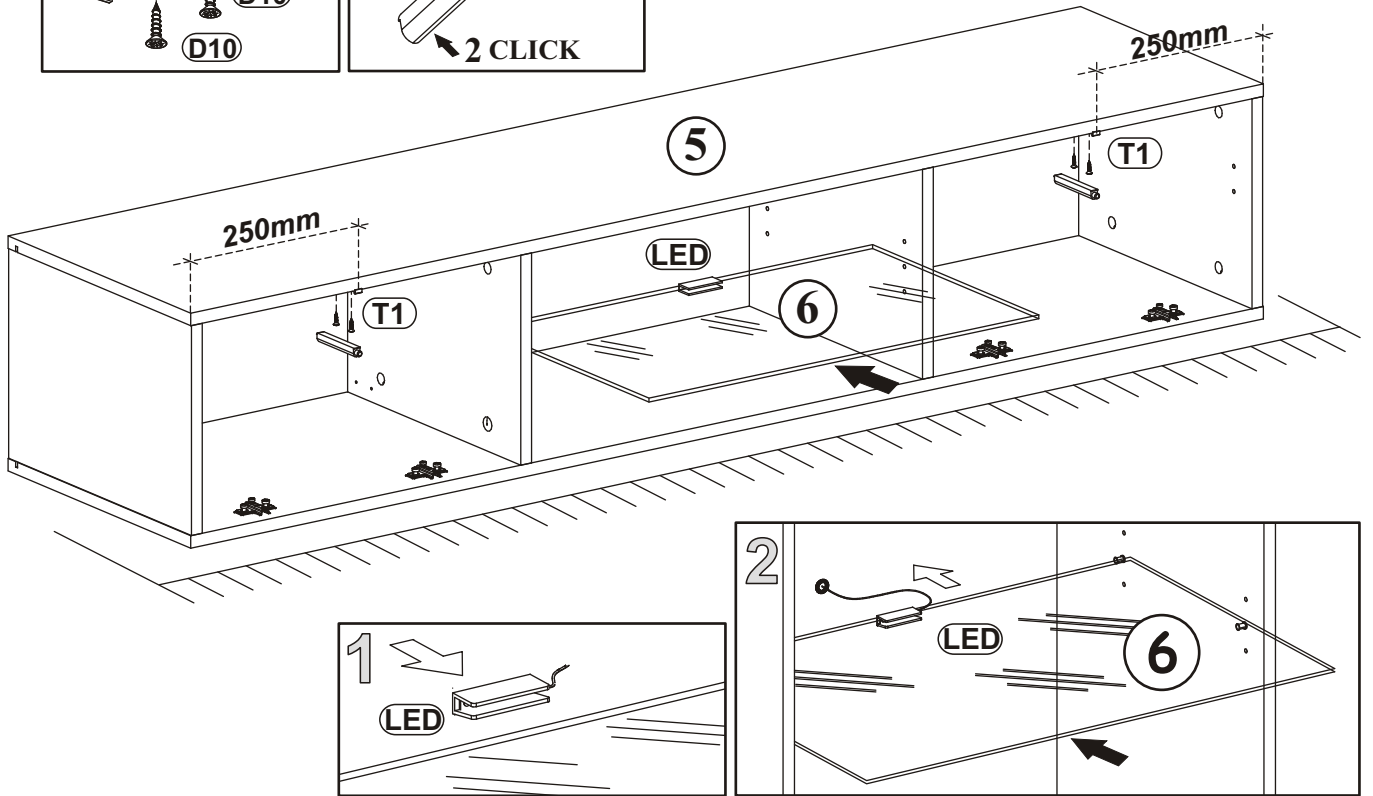

8

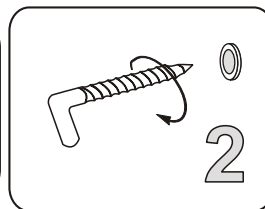
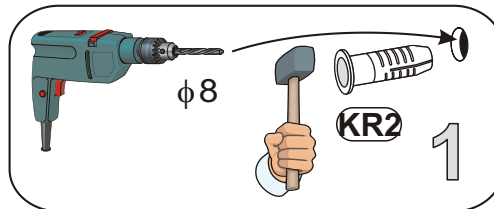
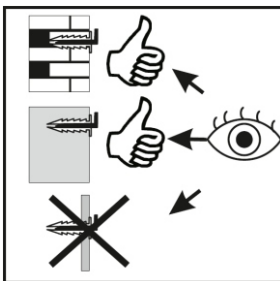

| | |
|-----|--|
| KR2 | |
| x4 | |

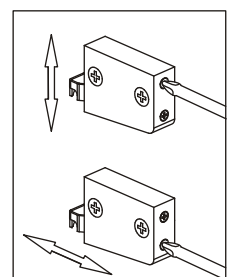
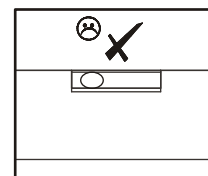
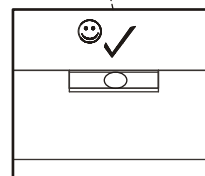
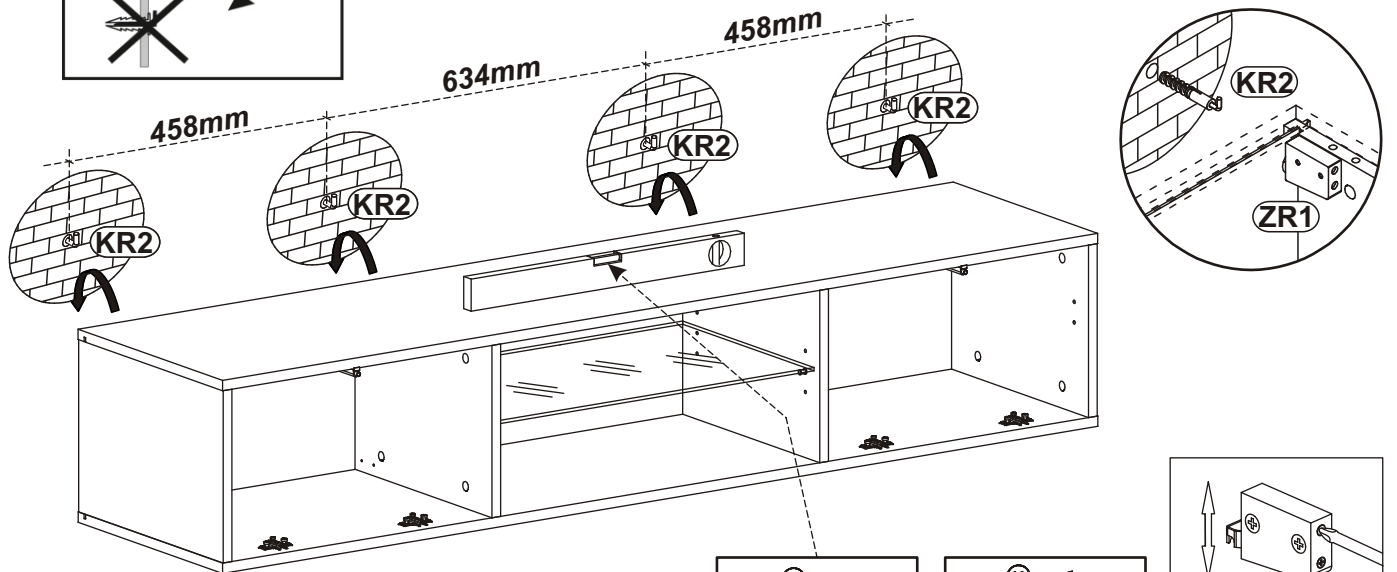

9

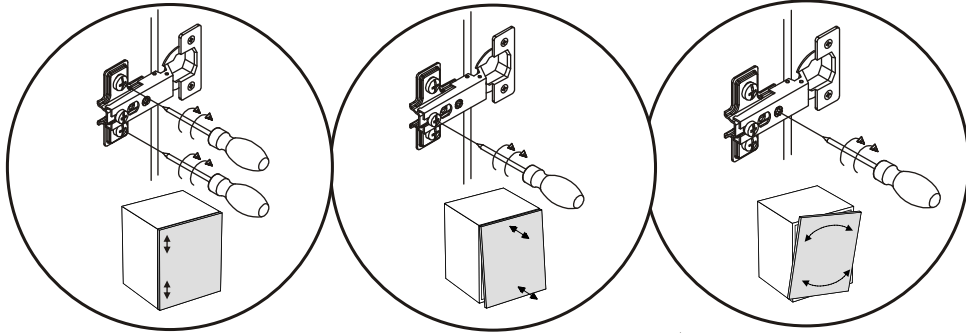
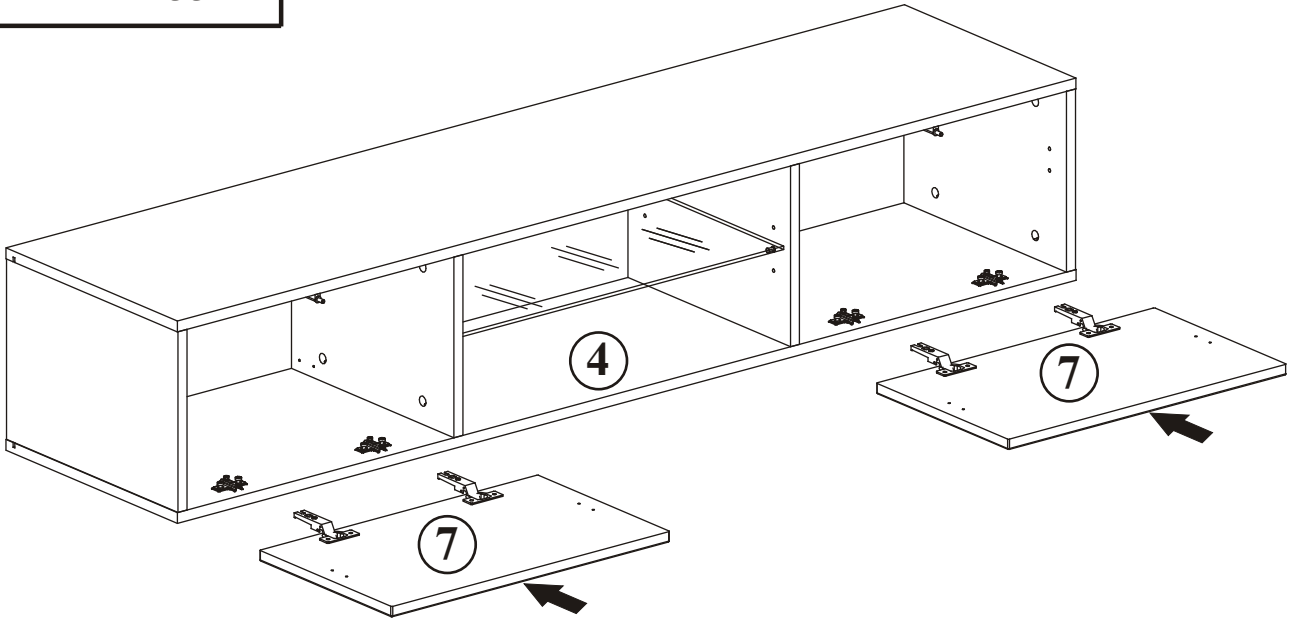

10

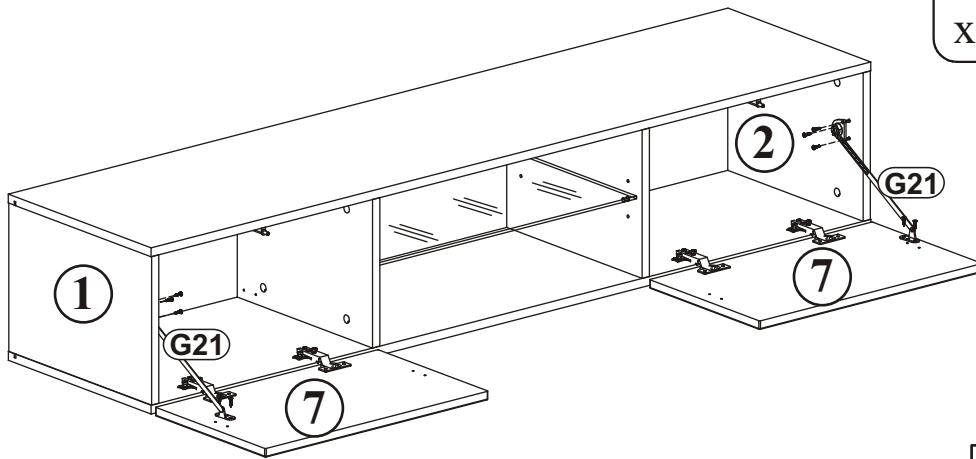

| | | | |
|-----|-----------|-----|---------|
| D10 | | G21 | |
| x4 | USØ3,5x13 | x2 | |
| | | D7 | |
| | | x6 | USØ3x16 |

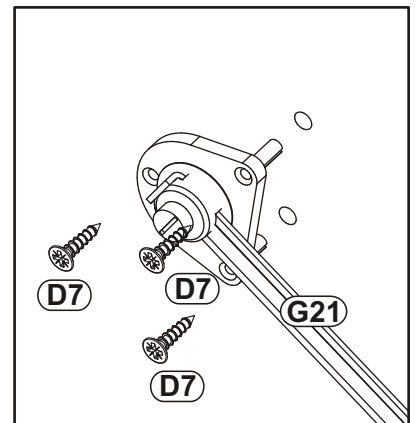
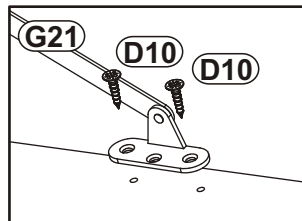



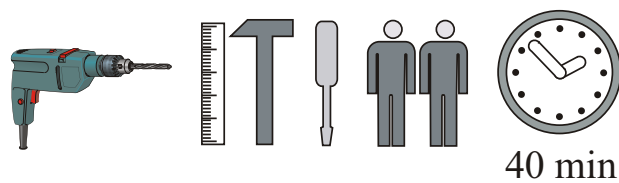
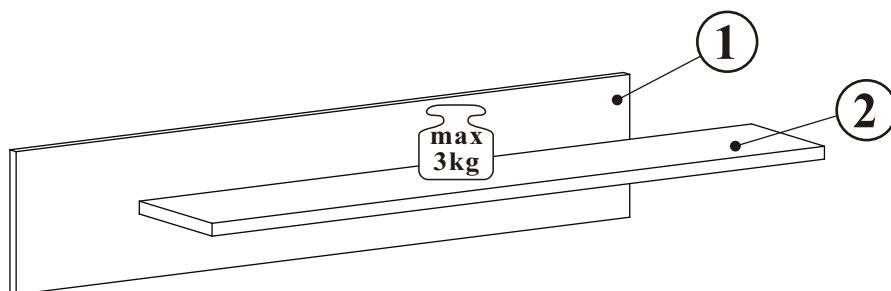
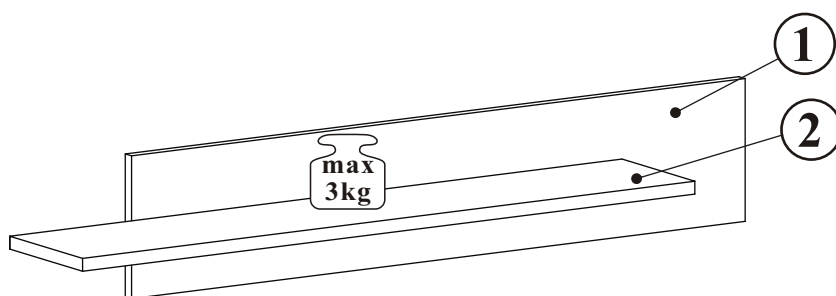
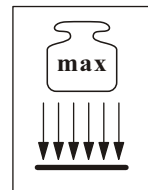
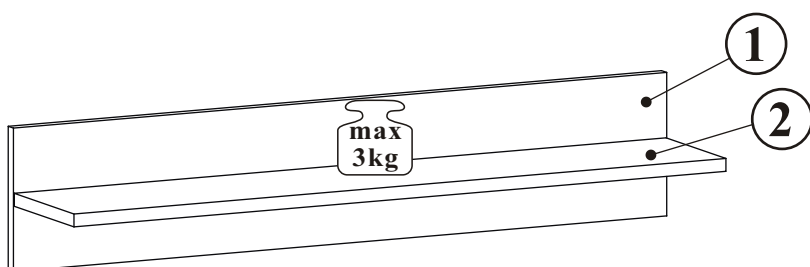



GALINO 23_MX

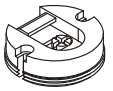

| NO | Dim. | | Col.-No | Qty |
|----|------|-----|---------|-----|
| 1 | 1002 | 200 | 1 | 2 |
| 2 | 1000 | 185 | 1 | 2 |

GALINO 23_MX

| | | | | | | | | | | | |
|-----------|---|-----------|---|------------|--|-----------|---|-----------|---|----------|---|
| ZM1 x4 |  | D20 x8 |  ESØ6x9,5 | B11 x12 |  Ø7x50 | G4 x12 |  | KR2 x4 |  | G2 x1 |  |
|-----------|---|-----------|---|------------|--|-----------|---|-----------|---|----------|---|

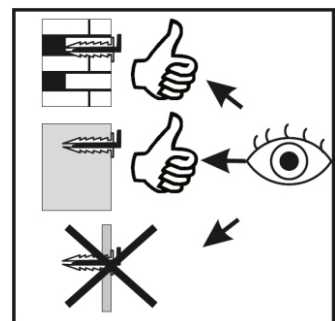
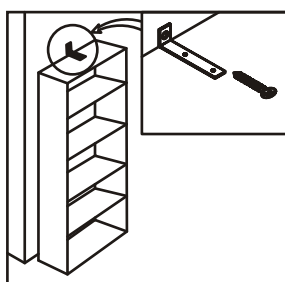
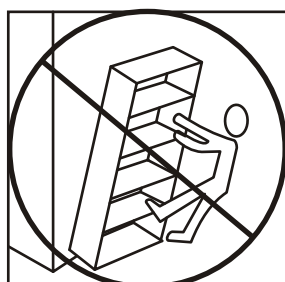
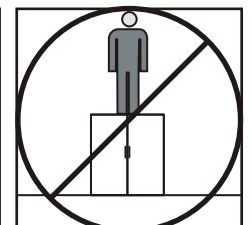
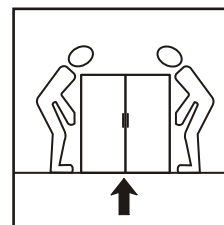
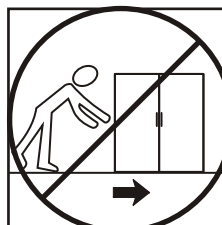
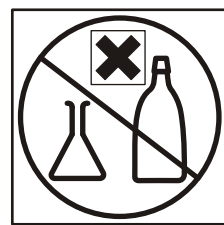
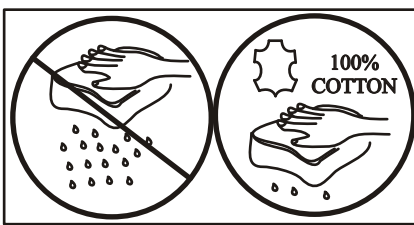
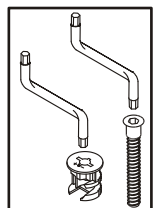
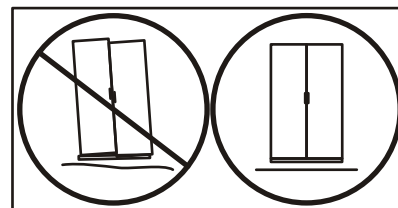
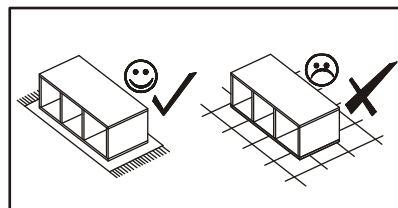
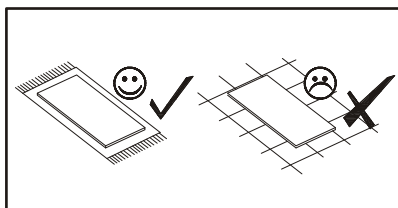
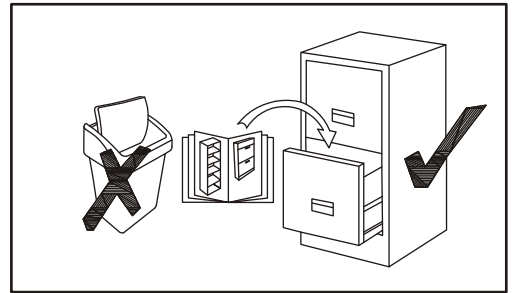
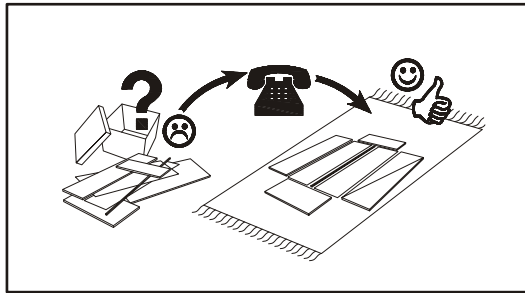
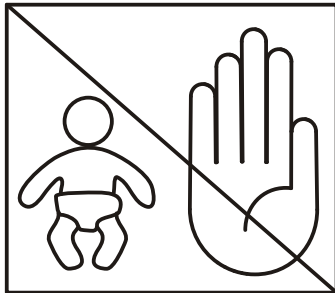
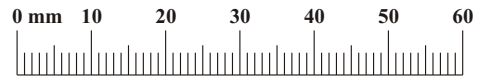

1-3

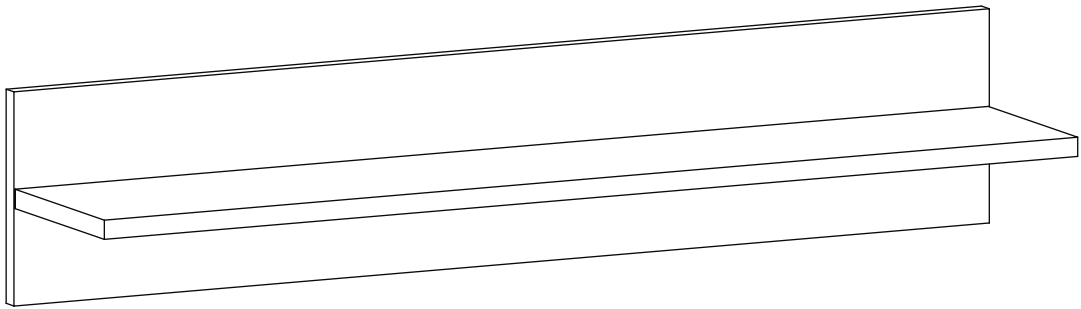

4-6

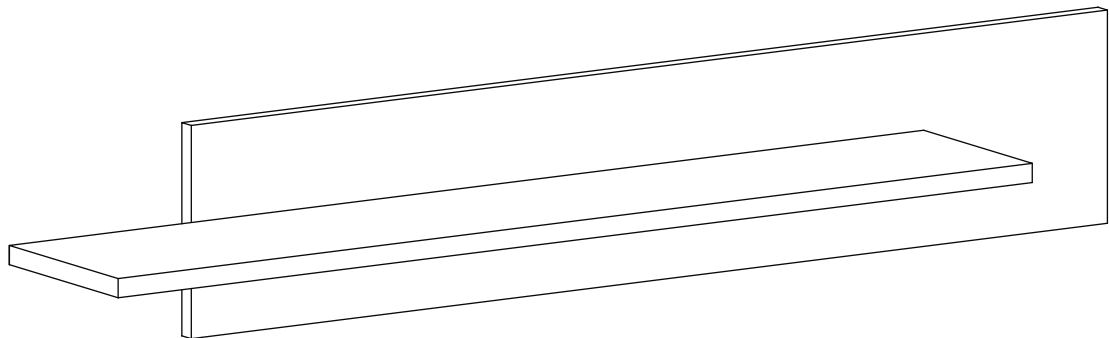

7-9

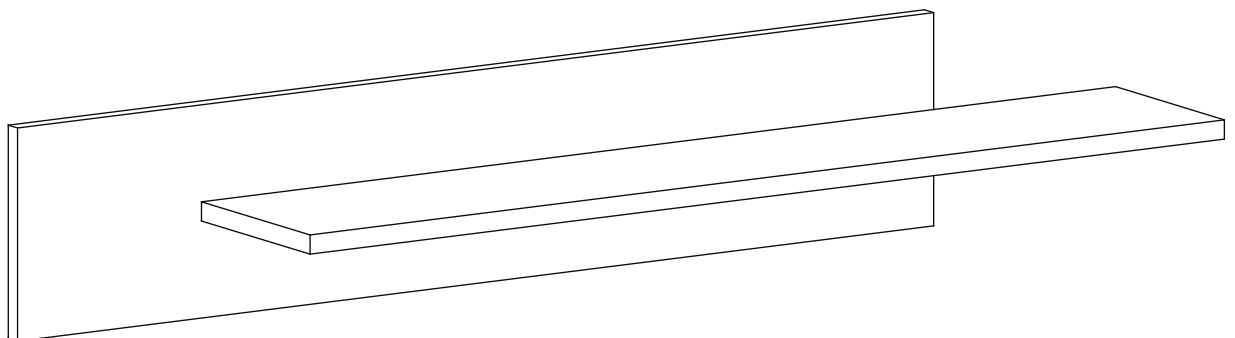

GALINO 23_MX

1

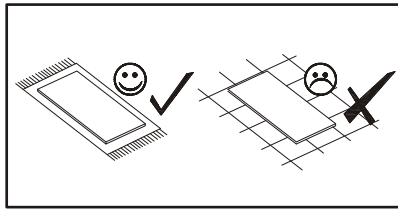

ZM1
x4

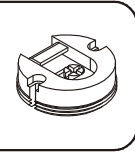

D20
x8

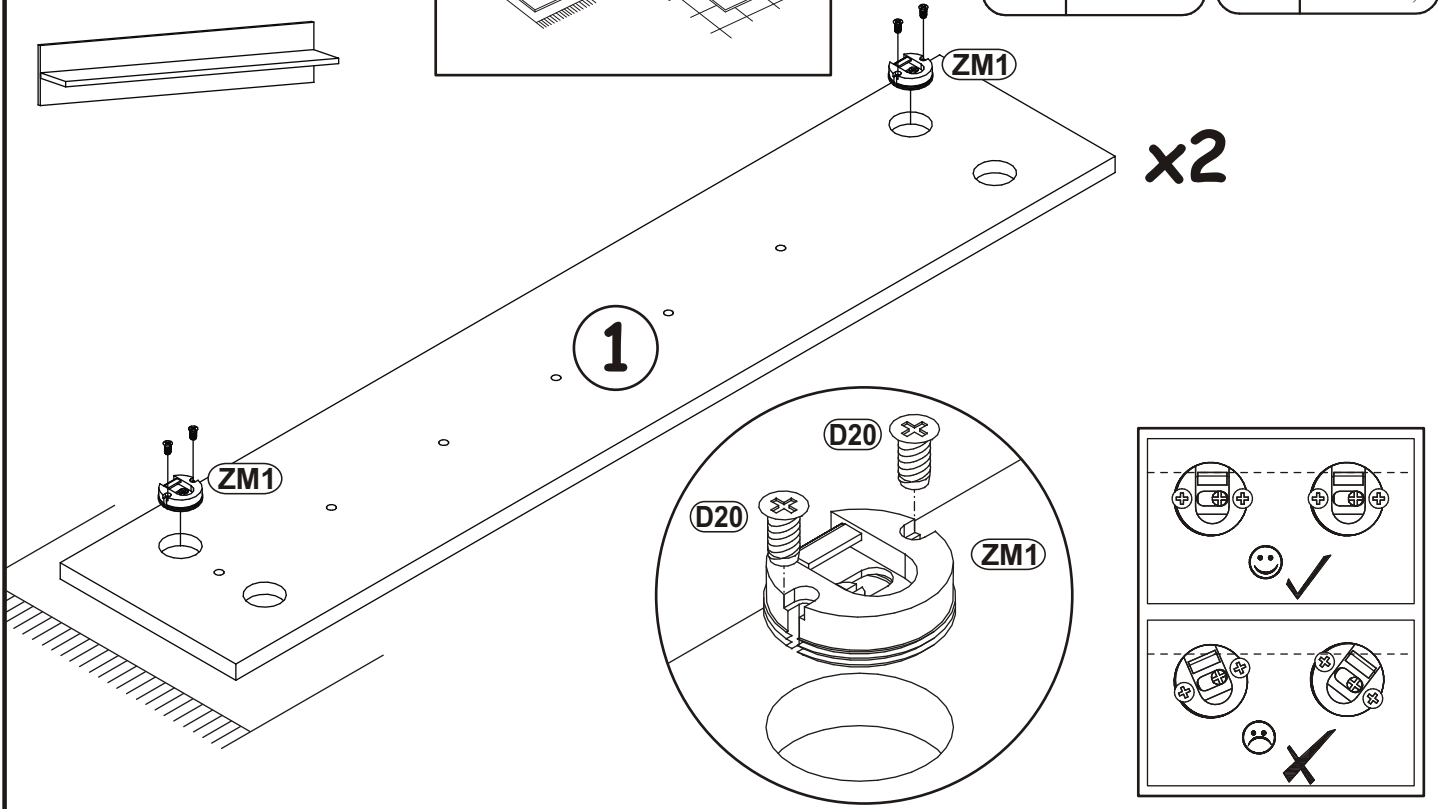
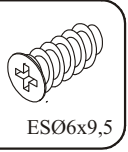

2

B11
x12

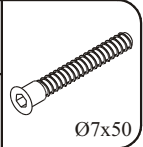

G4
x12

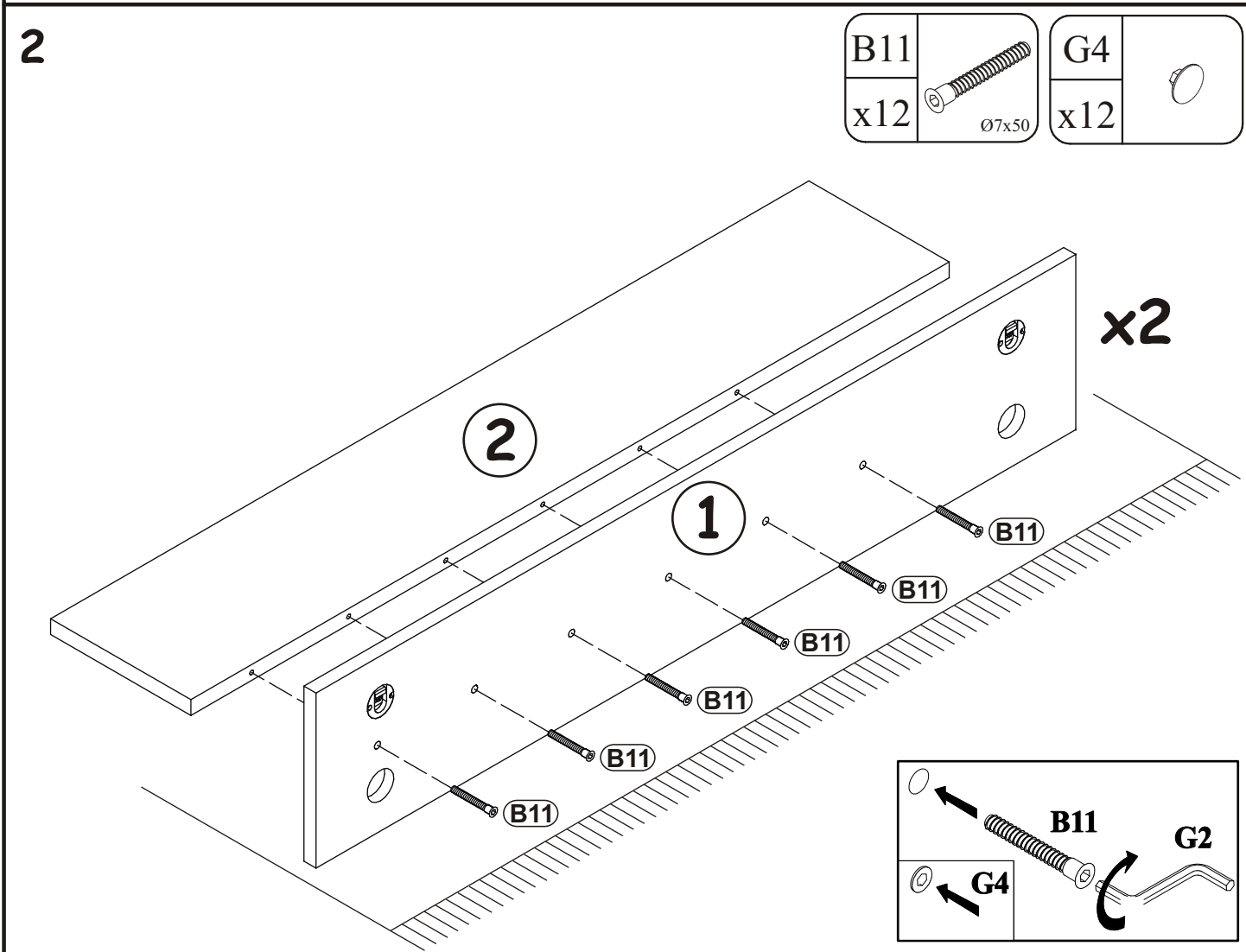
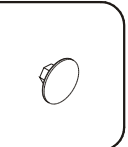

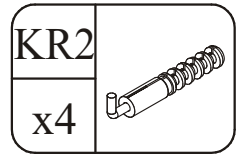

3

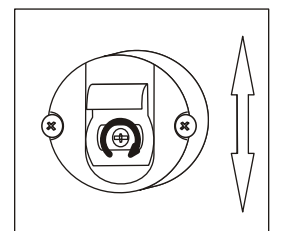
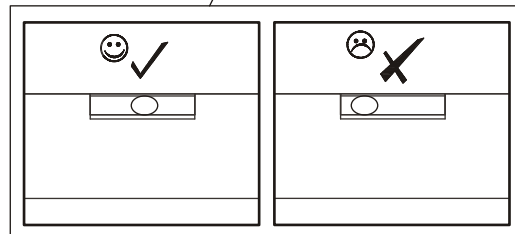
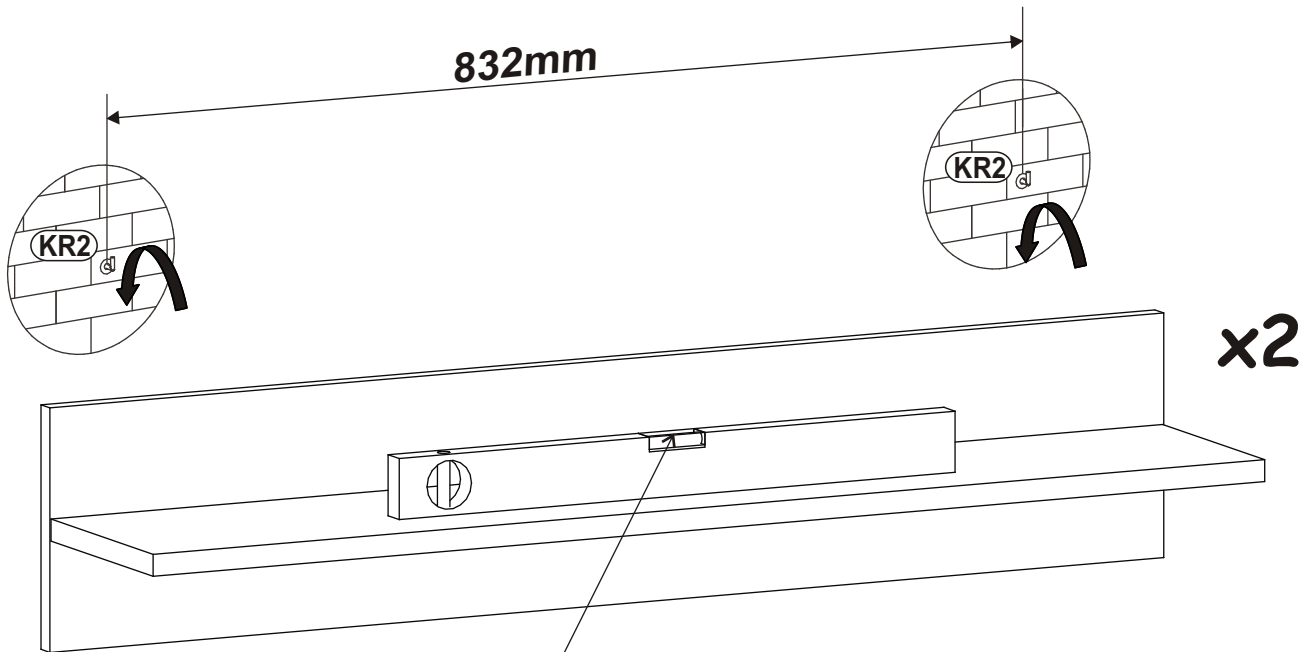
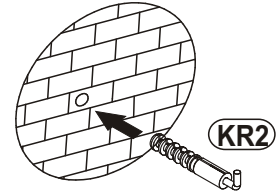
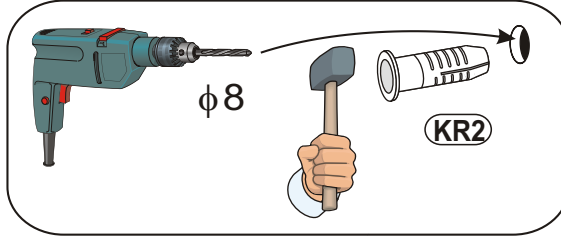
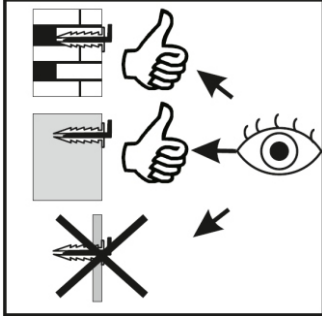

4

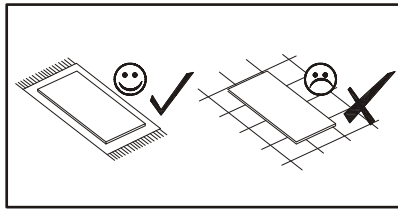

| | | | |
|-----|--|-----|----------|
| ZM1 | | D20 | |
| x4 | | x8 | ESØ6x9,5 |

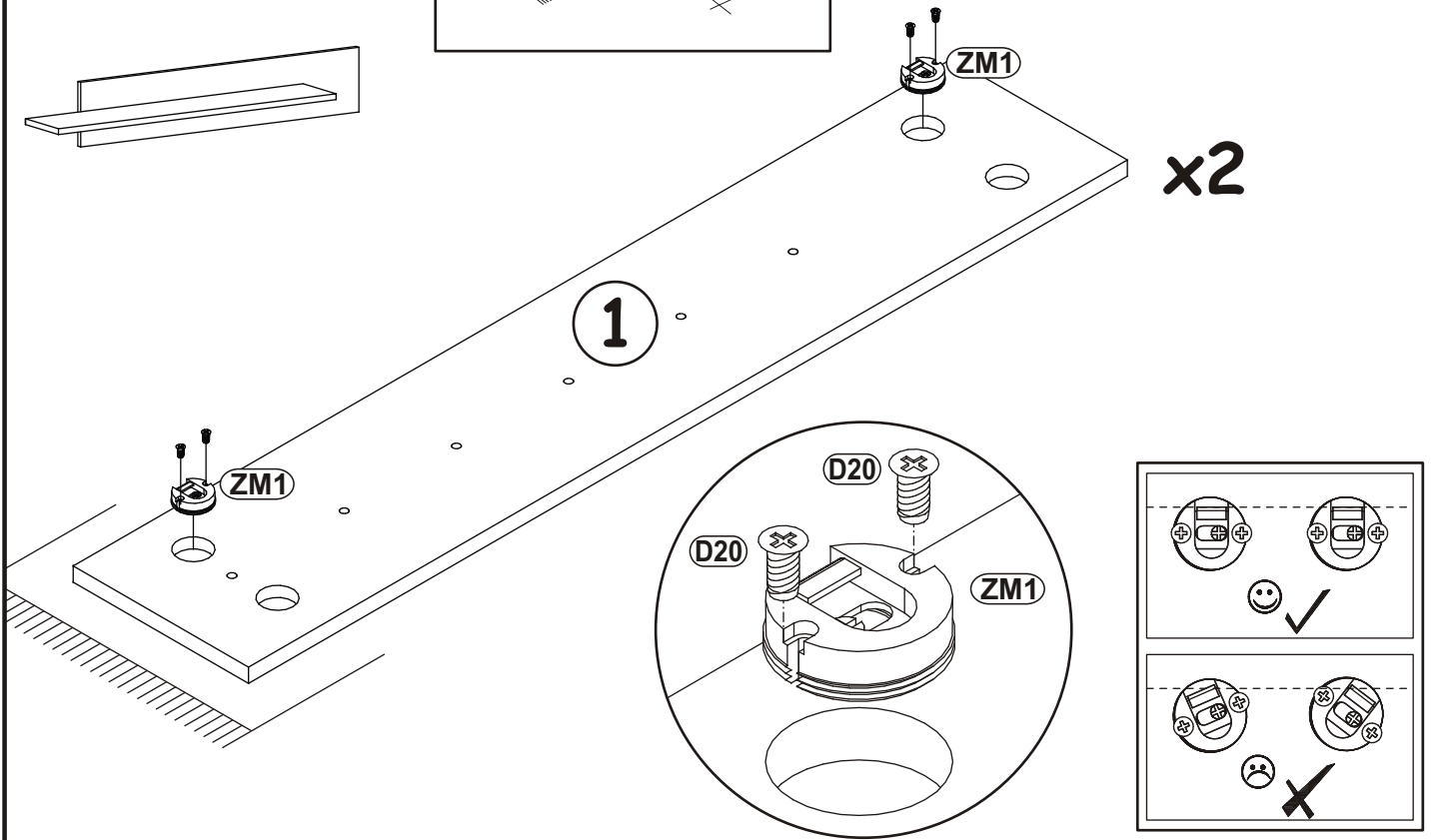

5

| | | | |
|-----|-------|-----|--|
| B11 | | G4 | |
| x12 | Ø7x50 | x12 | |

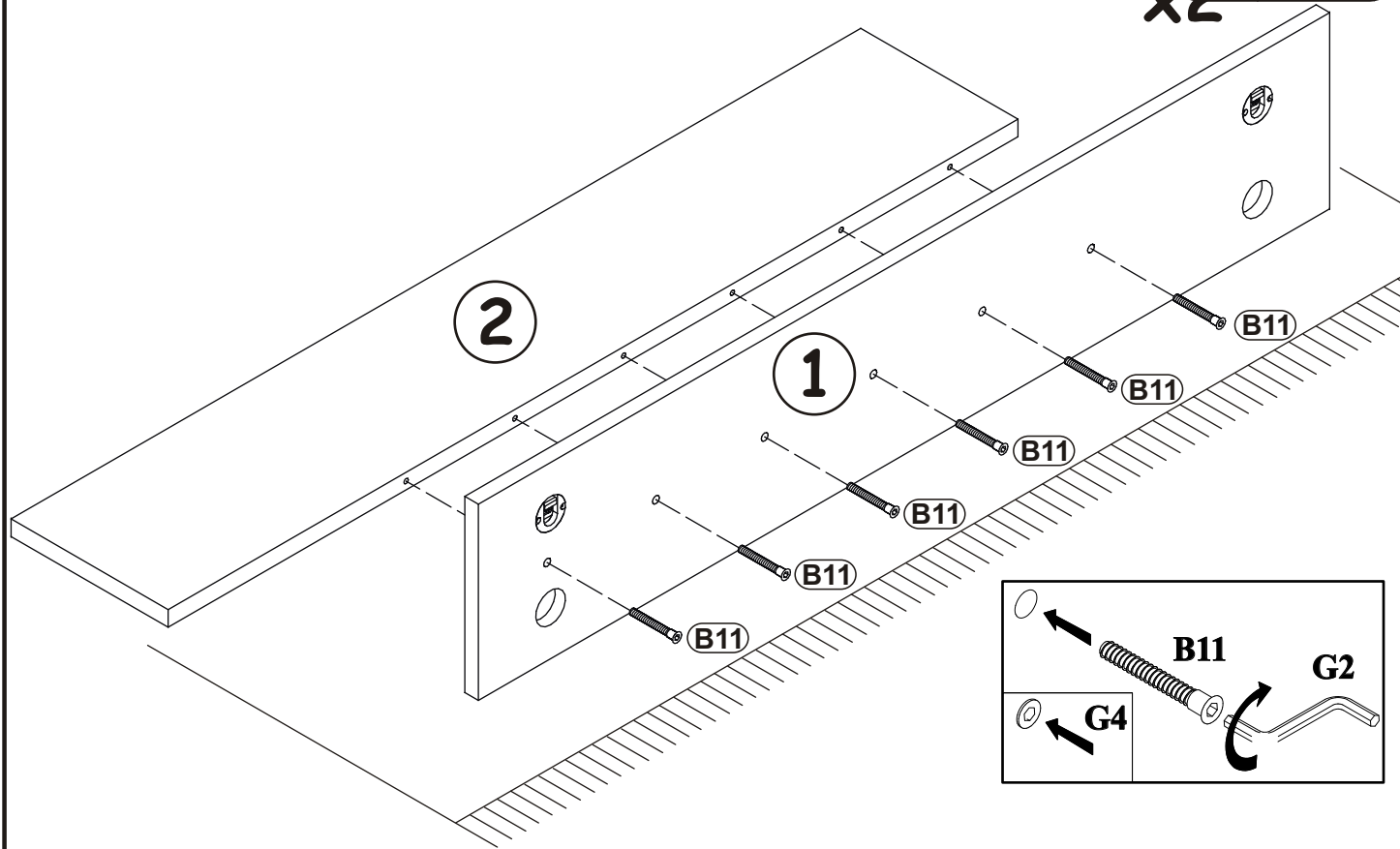

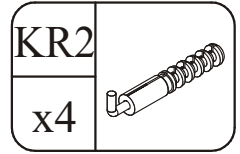

6

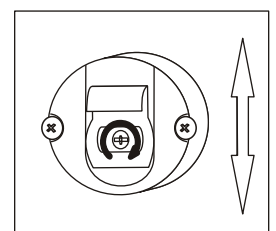
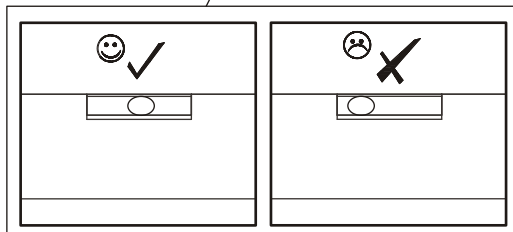
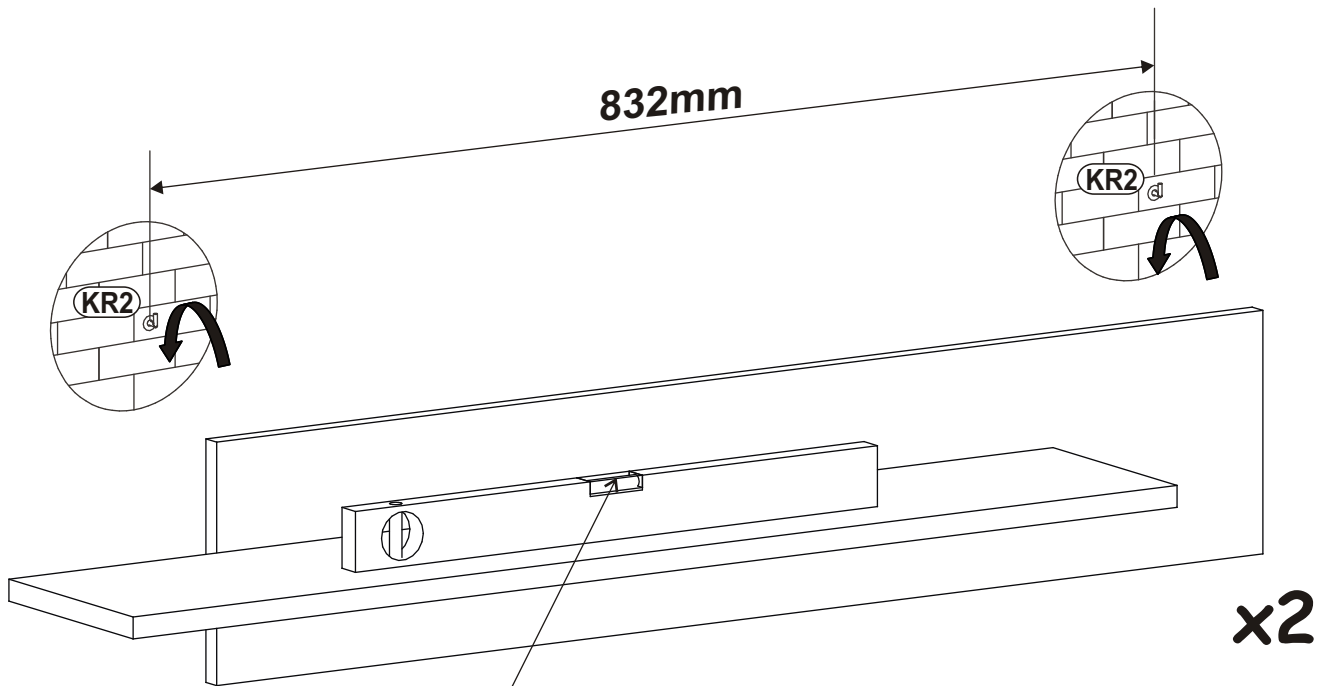
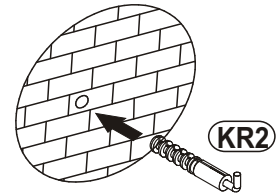
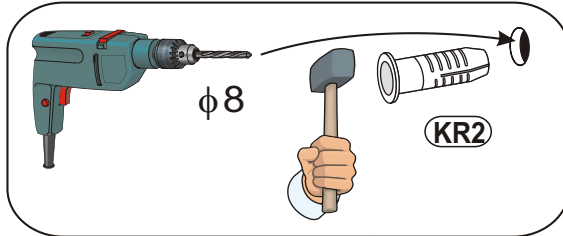
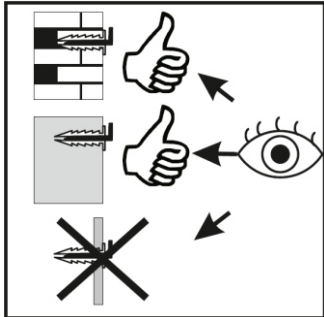

7

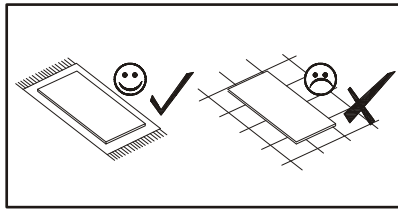

| | | | |
|-----|--|-----|----------|
| ZM1 | | D20 | |
| x4 | | x8 | ESØ6x9,5 |

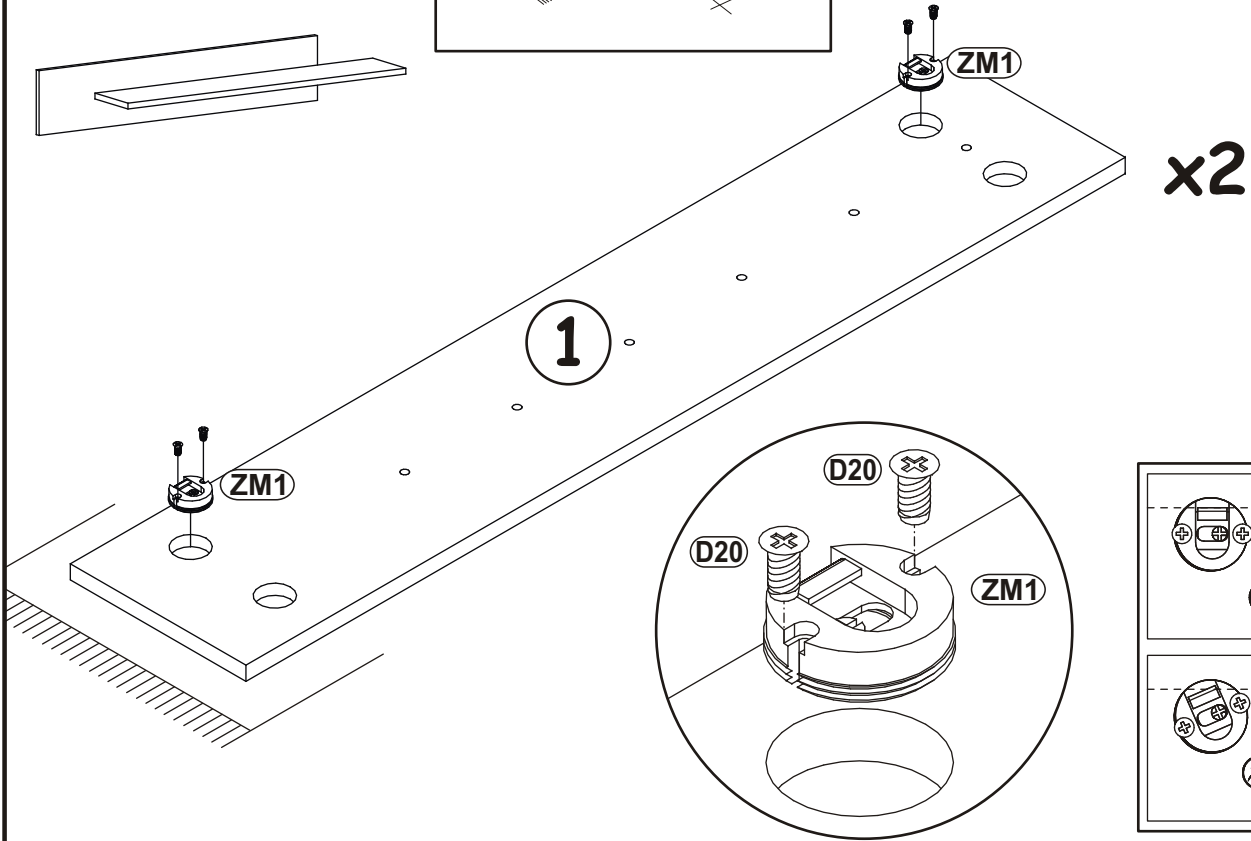

8

| | | | |
|-----|-------|-----|--|
| B11 | | G4 | |
| x12 | Ø7x50 | x12 | |

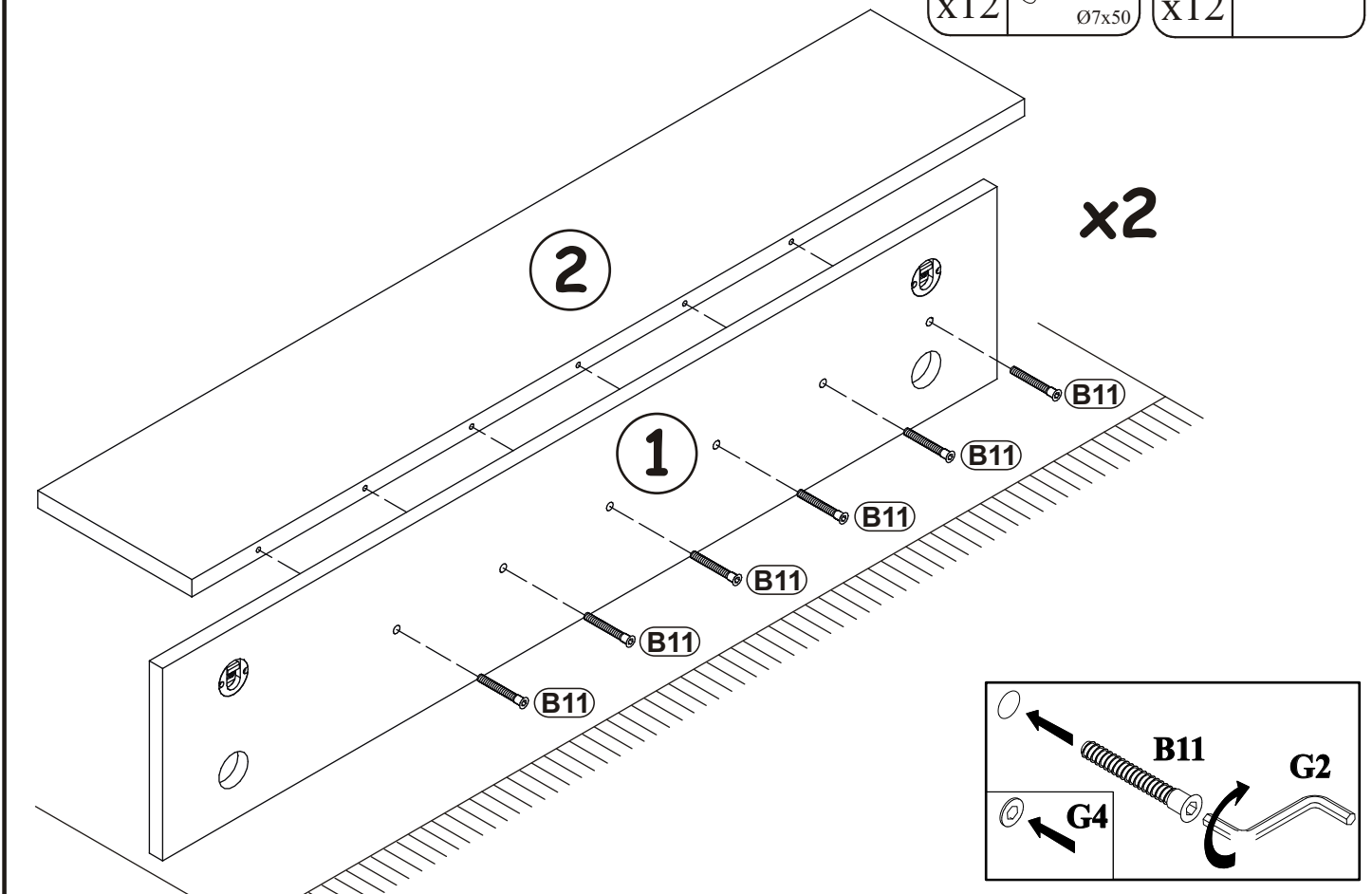

9

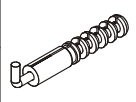
| | |
|-----|---|
| KR2 |  |
| x4 | |

