

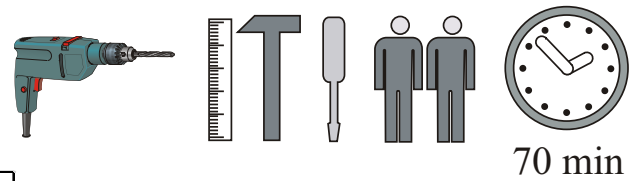

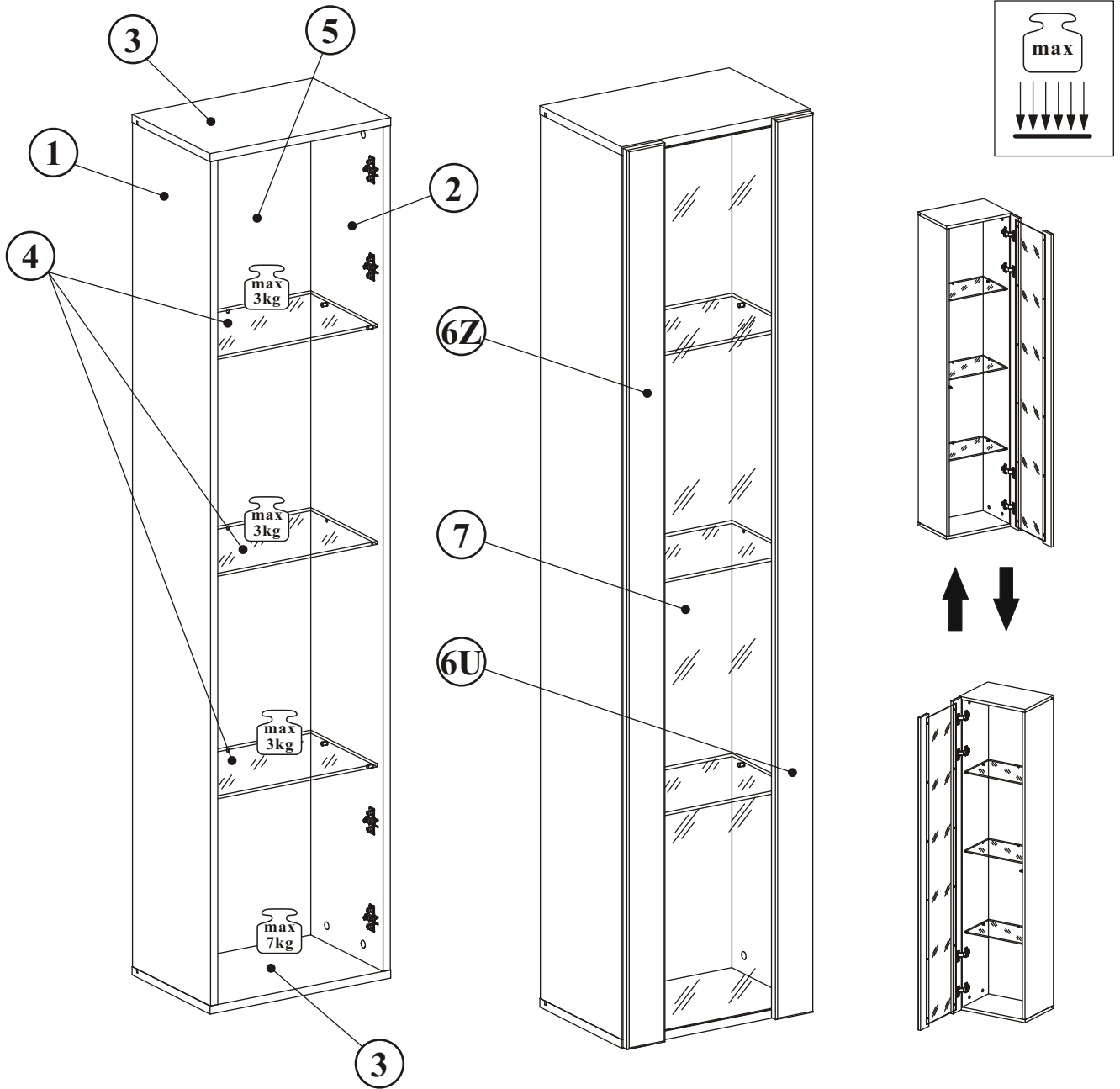

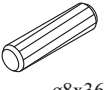

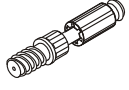

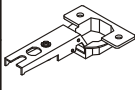
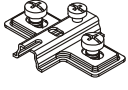
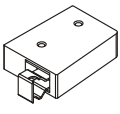

FLY TYP-41

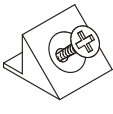

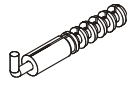
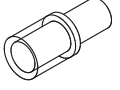
NO	Dim.			Col.-No	Qty
1	1668	274	16	1	1
2	1668	274	16	1	1
3	400	274	16	1	2
4	364	234	6	1	3
5	1680	378	3	1	1
6Z	80	1696	16	1	1
6U	80	1696	16	1	1
7	1664	283	4	1	1

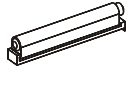
FLY TYP-41

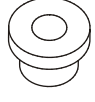
A1 x8  ø8x36	B4 x8 	B5 x8  ø15x12	G5 x8 	E1 x4  Ø26 H=0	E2 x4  H=0
ZR1 x2 	D6 x4  USØ3,5x30	S1 x12 	D10 x10  USØ3,5x13	KR2 x2 	G20 x12 
Z2 x8  Ø5	T1 x1 	G2 x1 	UP13 x12  UPØ3x16	P2 x12 	

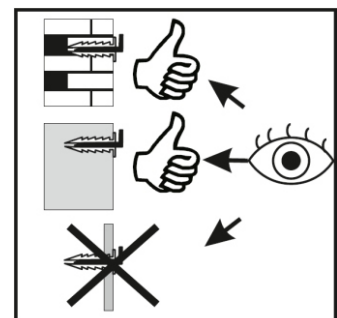
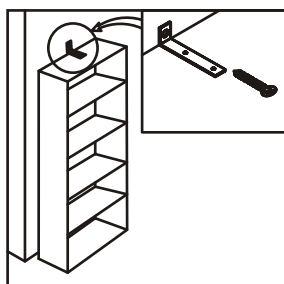
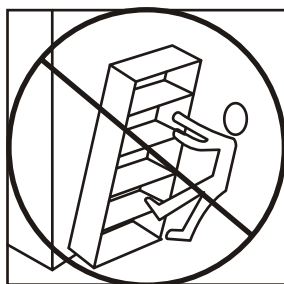
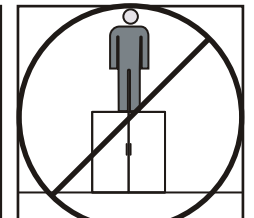
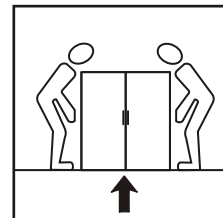
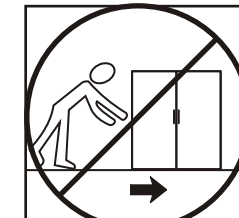
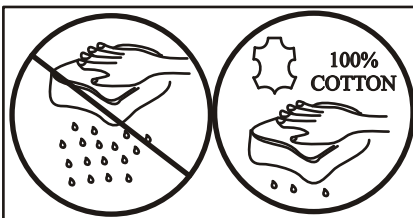
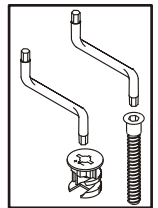
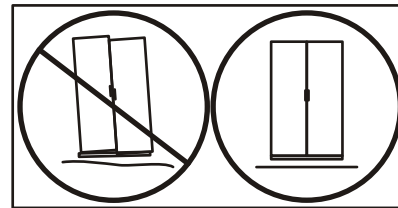
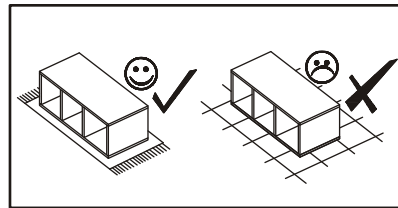
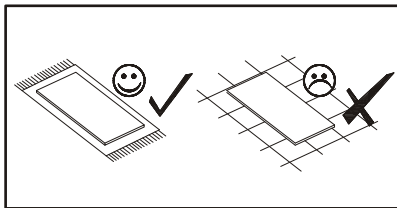
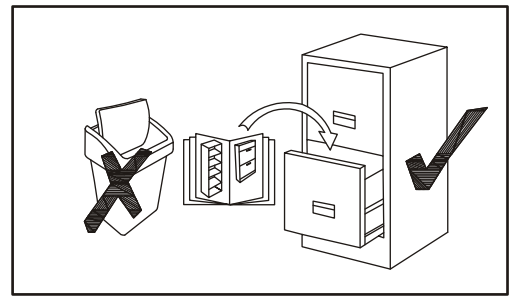
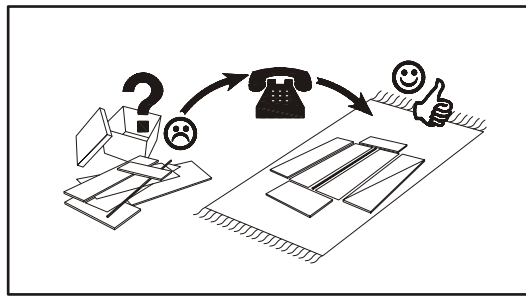
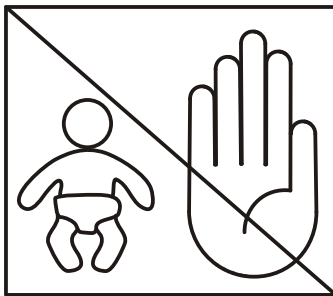
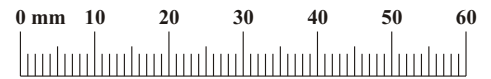

FLY TYP-41

1

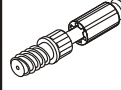
B4	
x8	

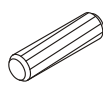
A1	
x8	ø8x36

B5	
x8	ø15x12

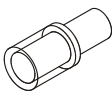
G20	
x12	

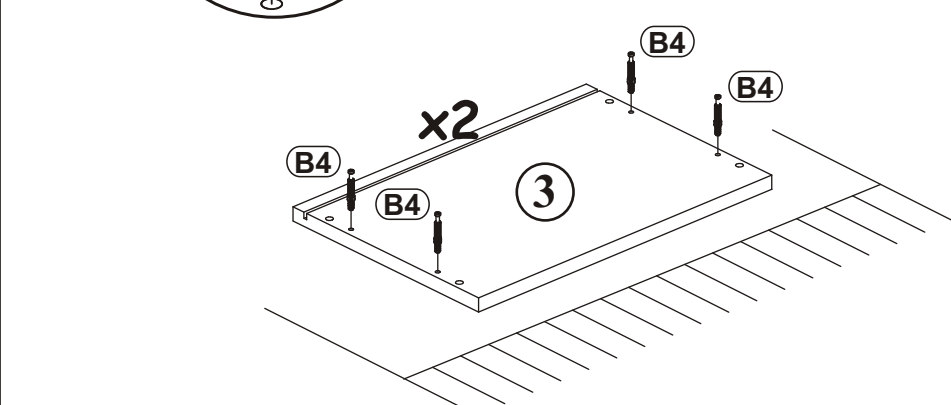
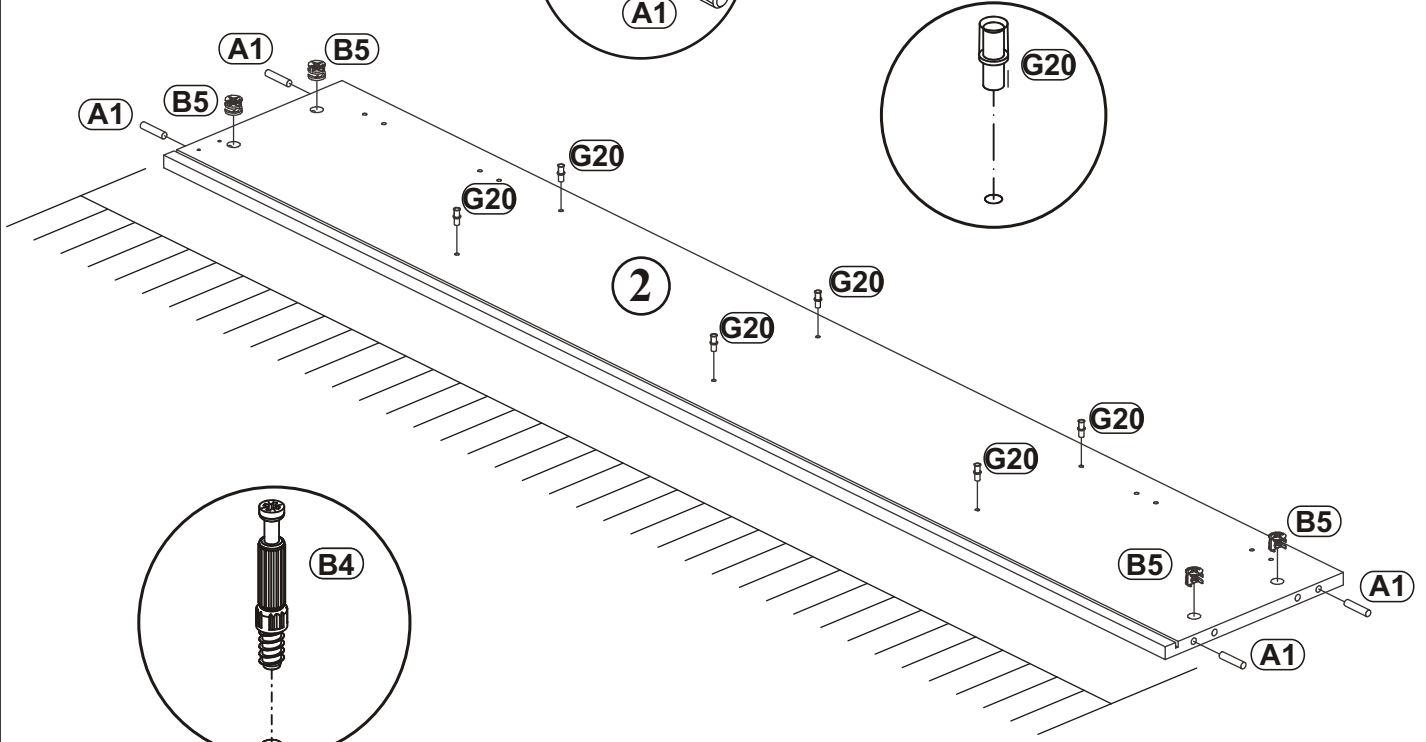
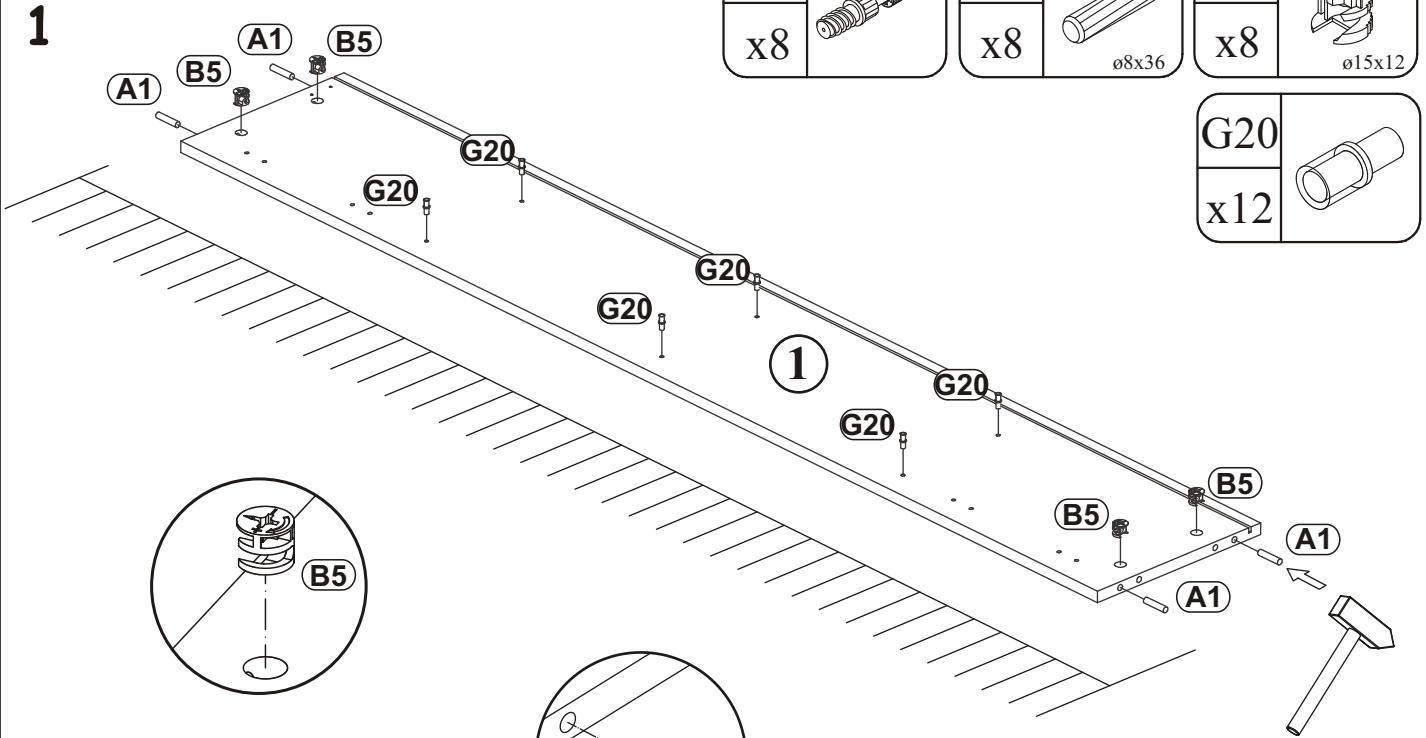

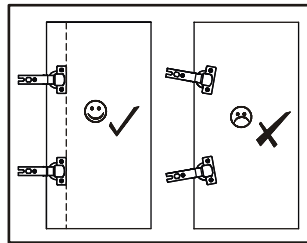
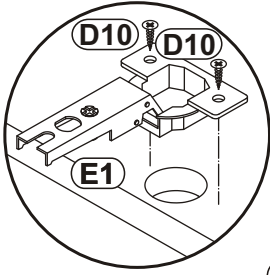

FLY TYP-41

2

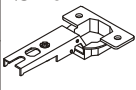

D10	
x8	USØ3,5x13

E1	
x4	Ø26 H=0

P2	
x12	

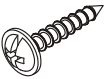
UP13	
x12	UPØ3x16

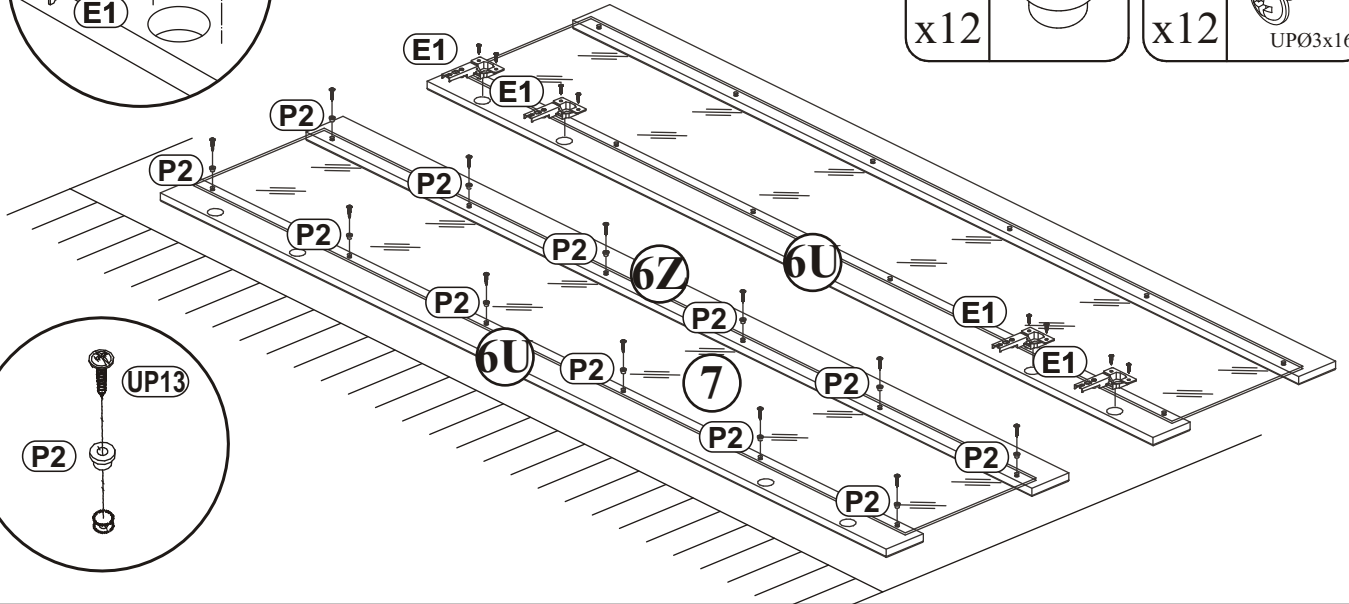
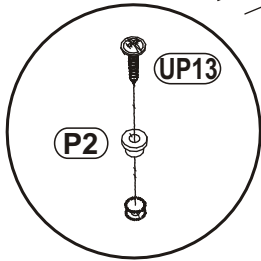

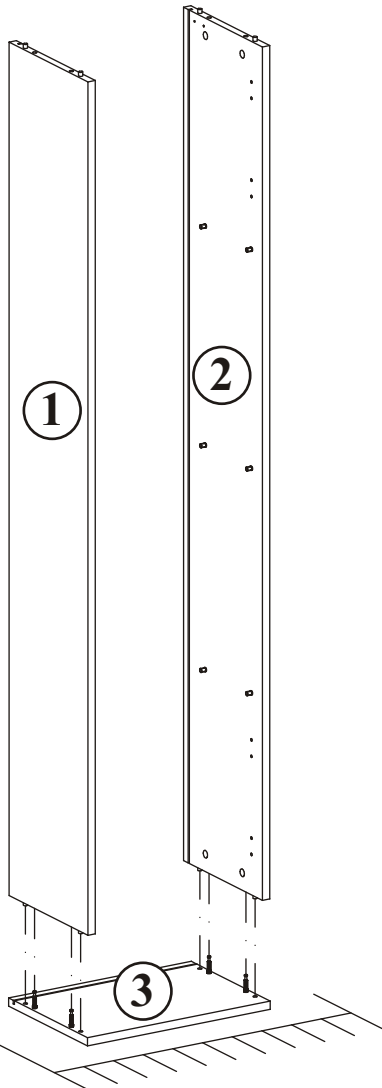

3

a)

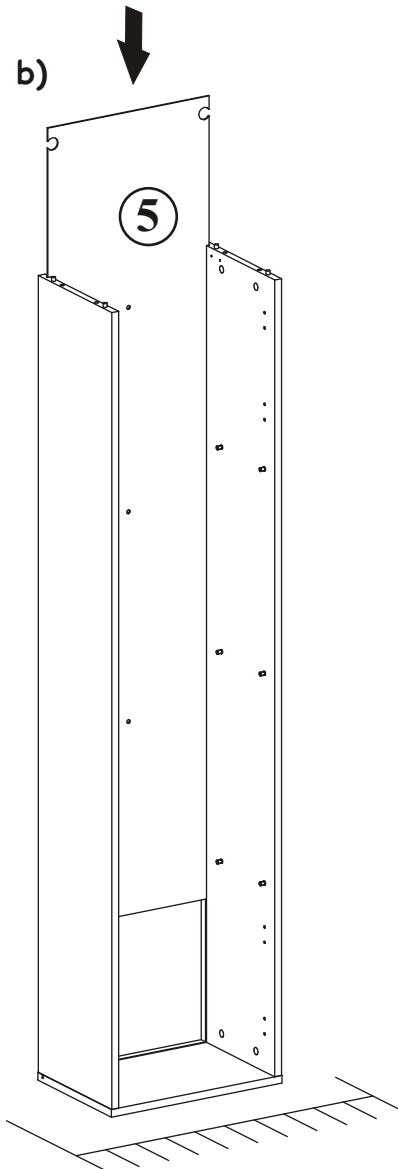

b)



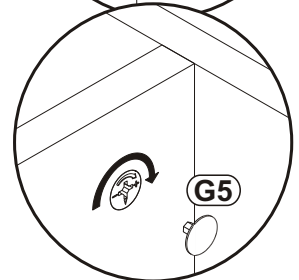
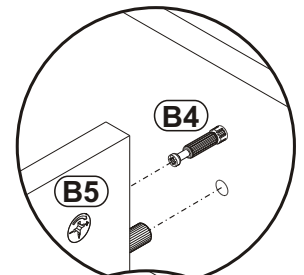

G5	
x4	

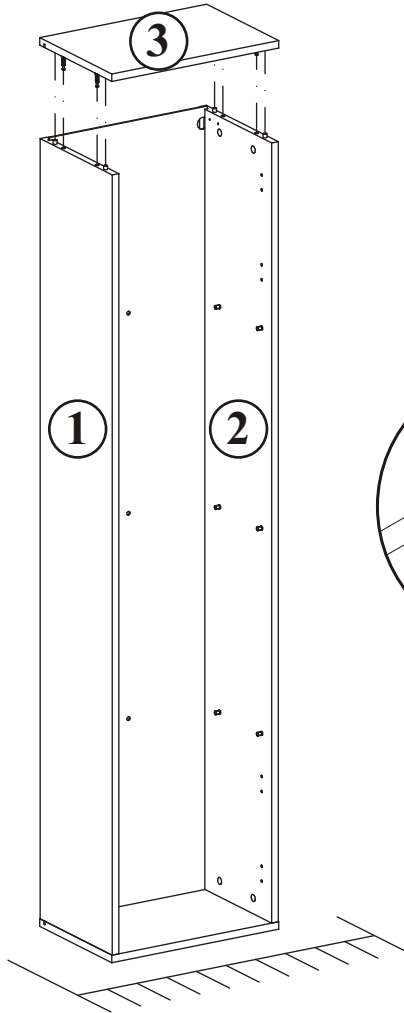

FLY TYP-41

4



G5	
x4	

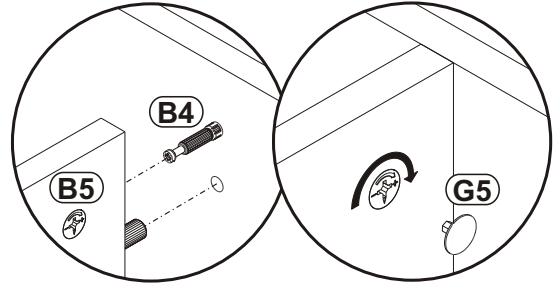

5

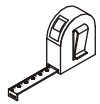

$X=Y$ 90°

Y

X

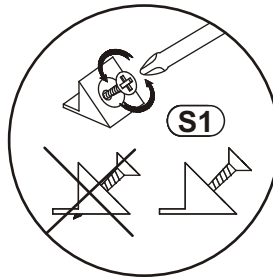
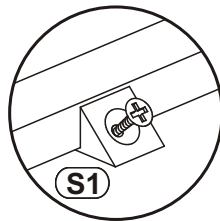

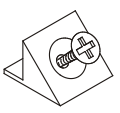
S1	
x12	

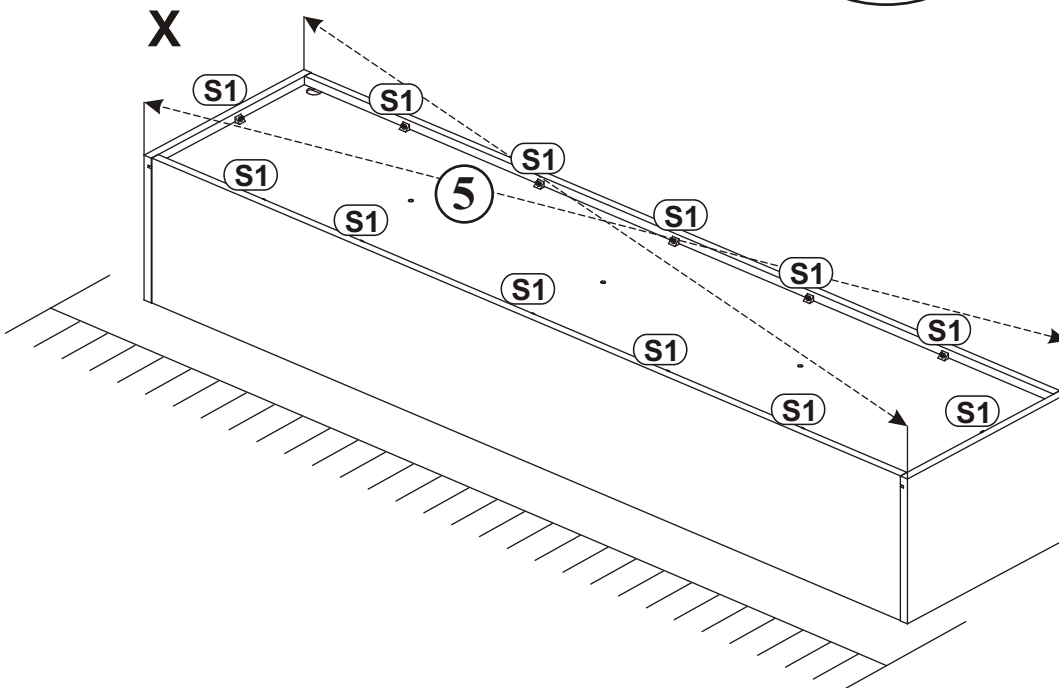

6

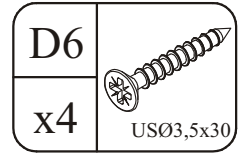
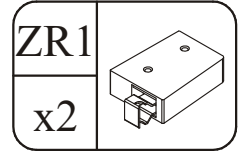
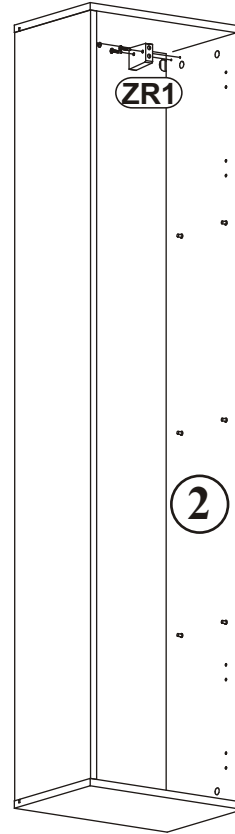
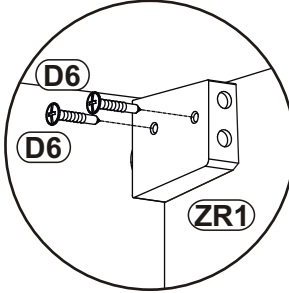
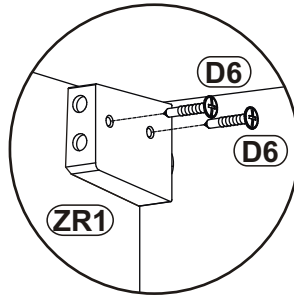
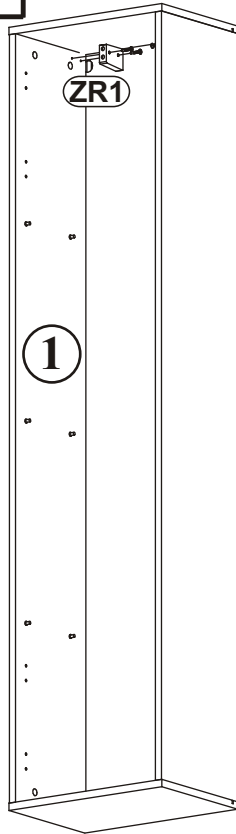

7

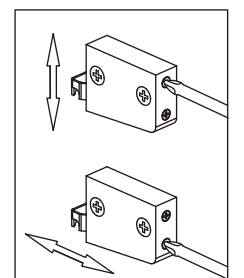
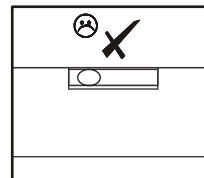
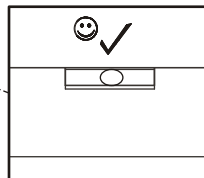
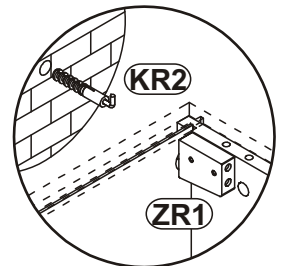
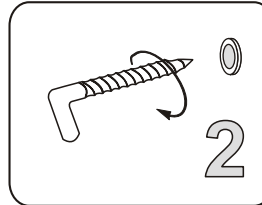
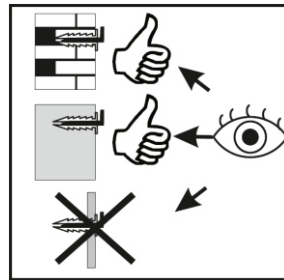
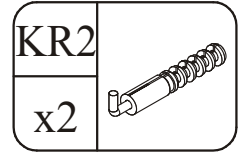
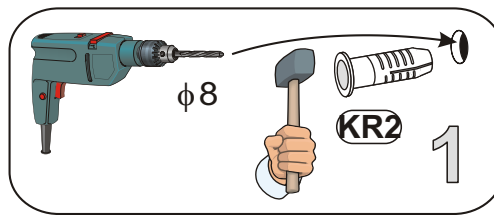
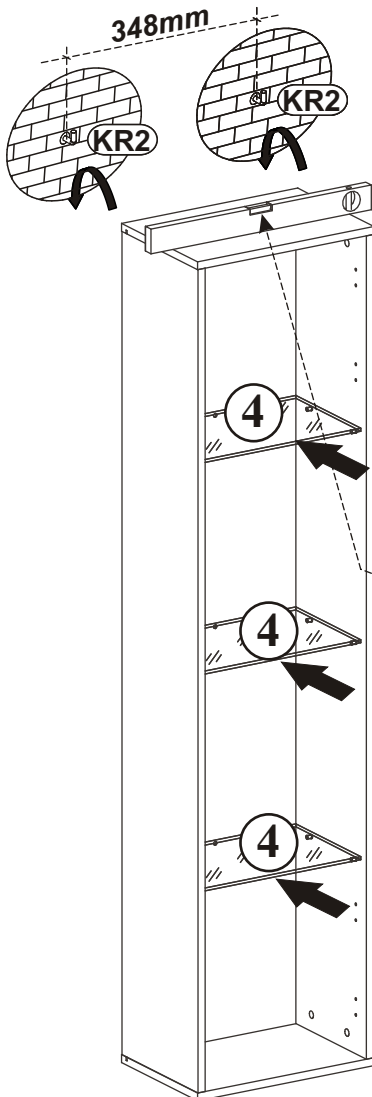

8 - 9

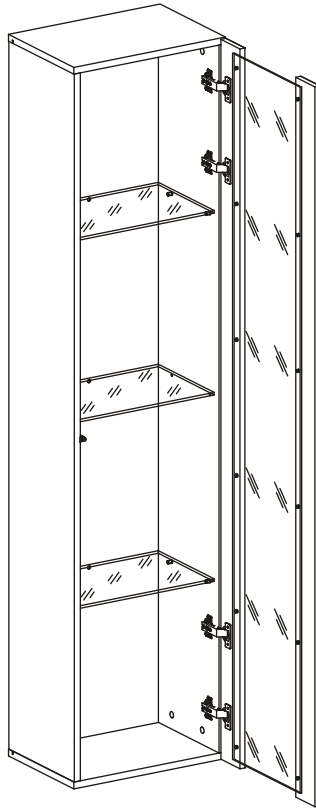

10 - 11

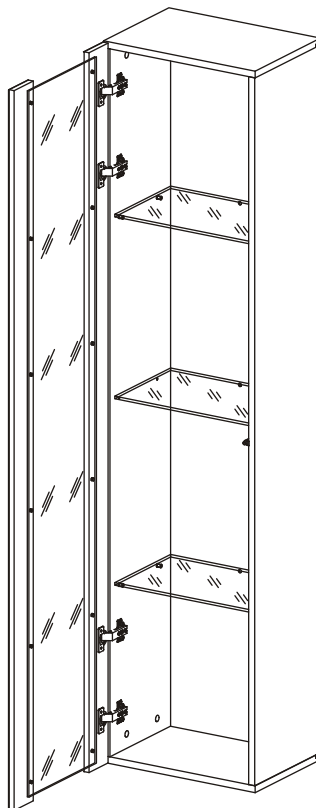

FLY TYP-41

8

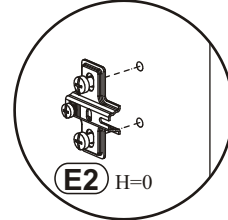
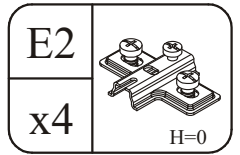
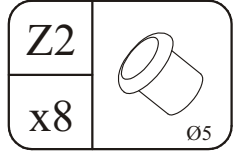
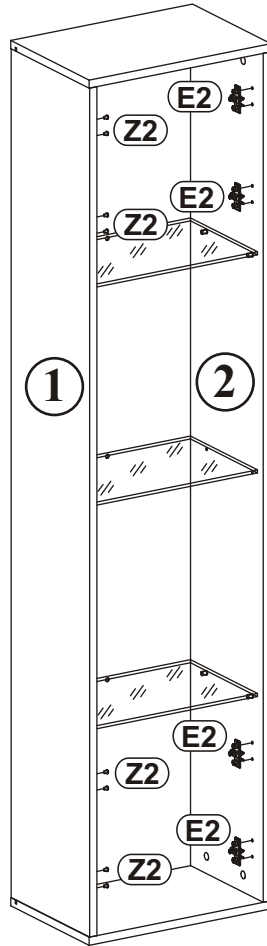
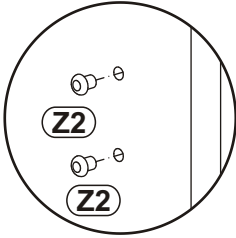

9

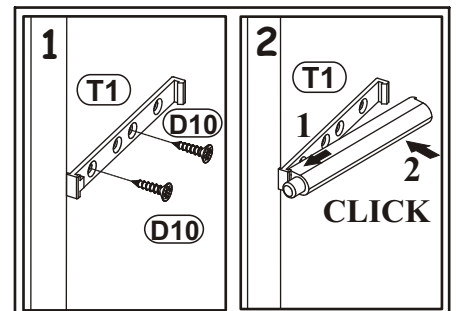
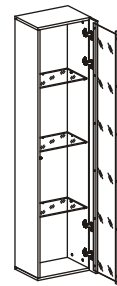
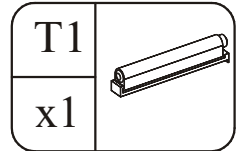
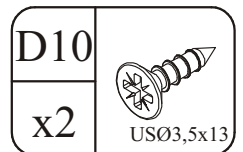
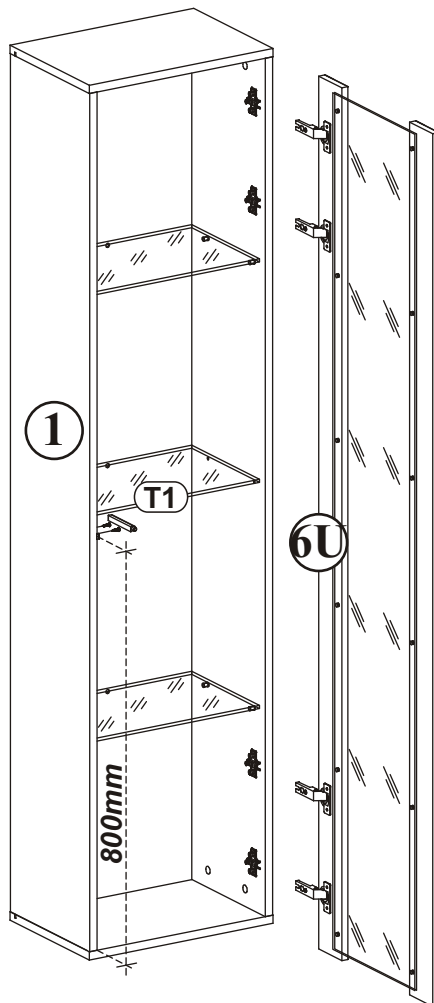
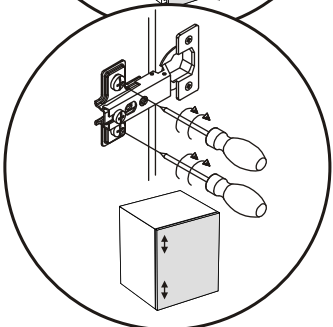
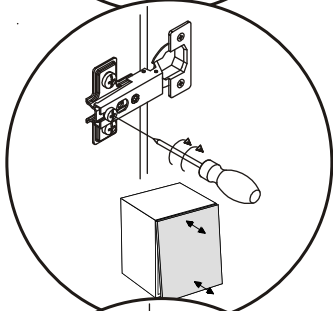
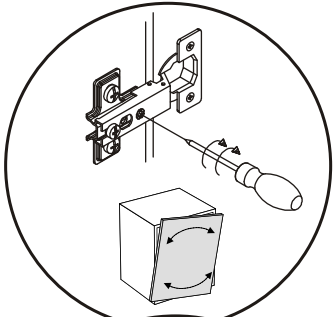

FLY TYP-41

10

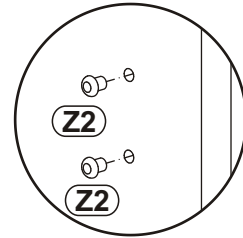
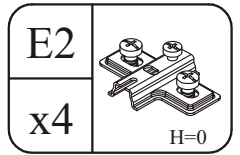
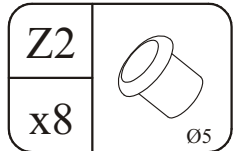
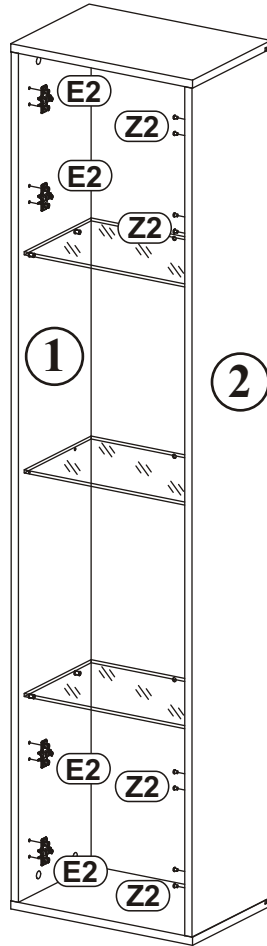
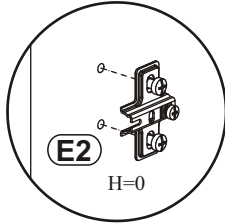
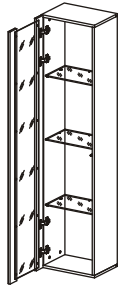

11

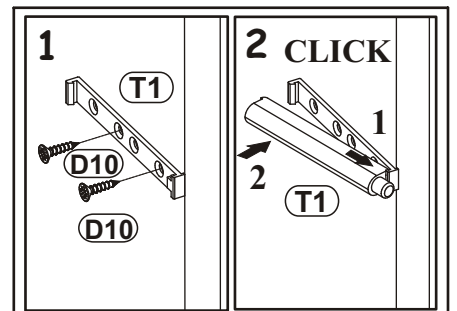
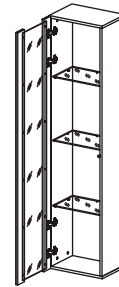
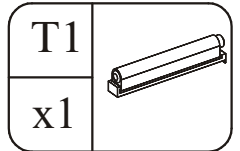
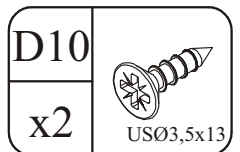
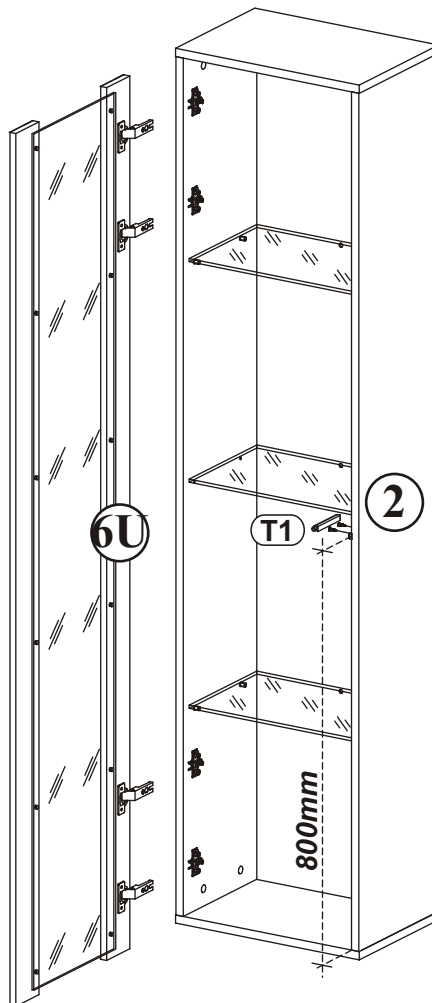
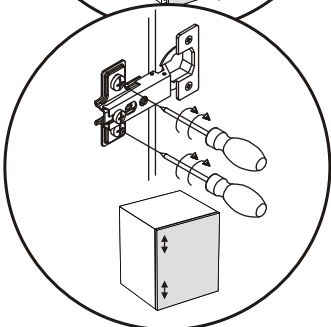
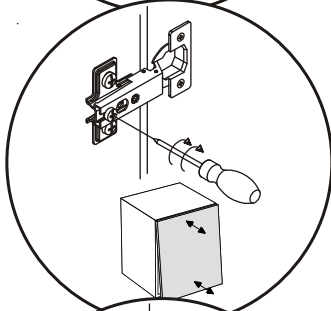
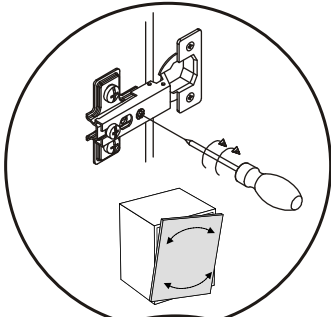



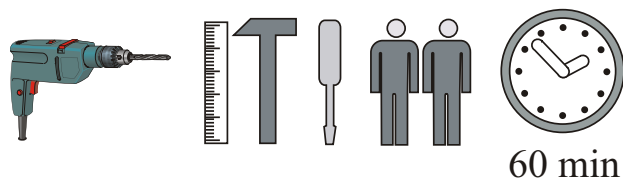
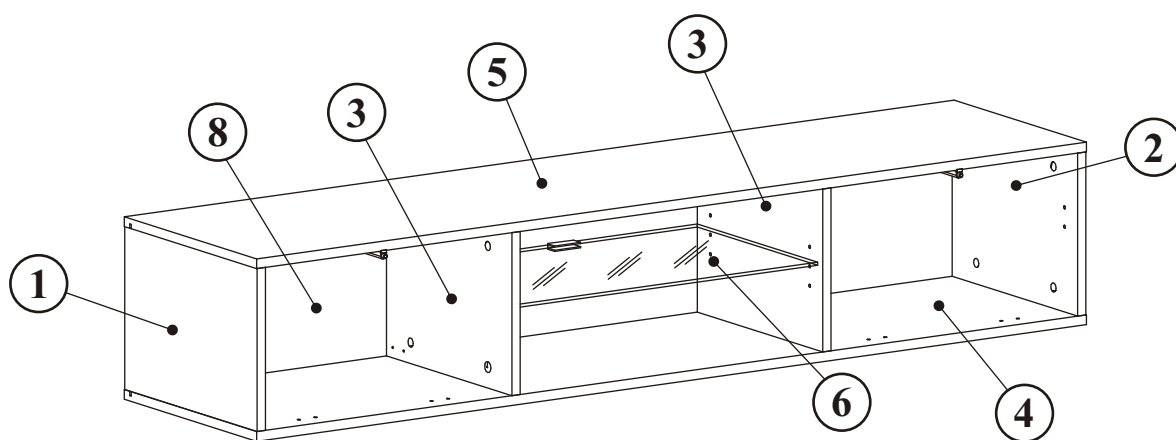
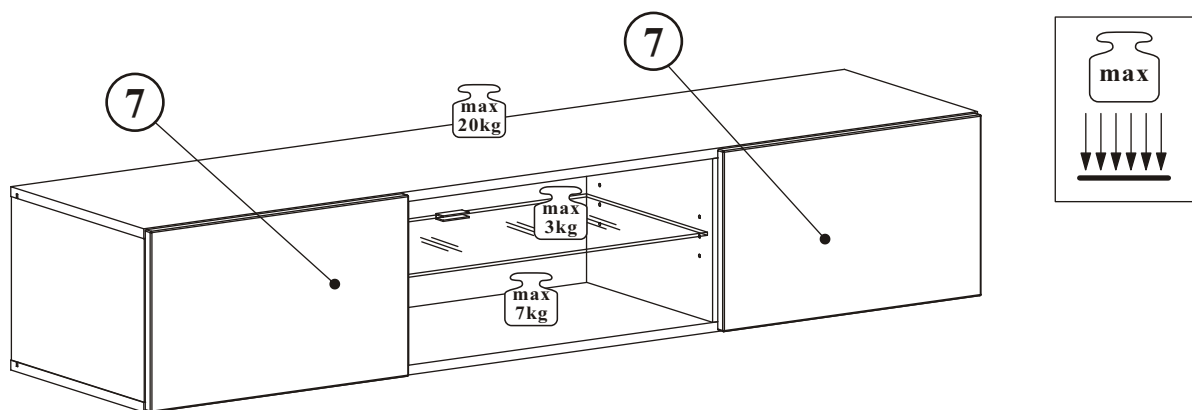





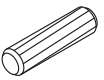
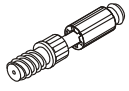

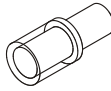

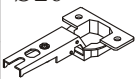
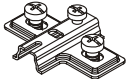
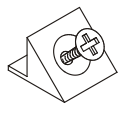
FLY TYP-33



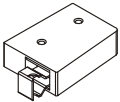

NO	Dim.			Col.-No	Qty
1	268	384	16	1	1
2	268	384	16	1	1
3	268	364	16	1	2
4	1602	384	16	1	1
5	1602	384	16	1	1
6	582	349	6	1	1
7	496	296	16	1	2
8	1580	280	3	1	1

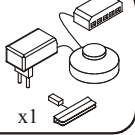
FLY TYP-33

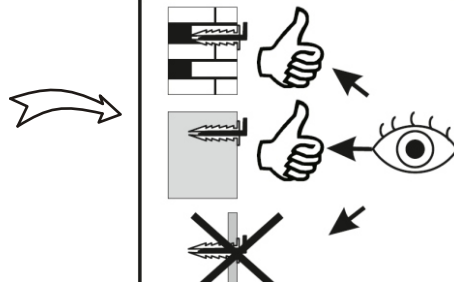
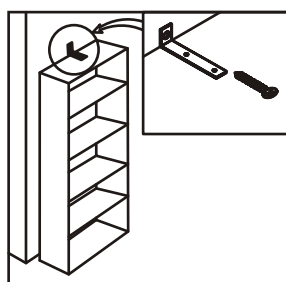
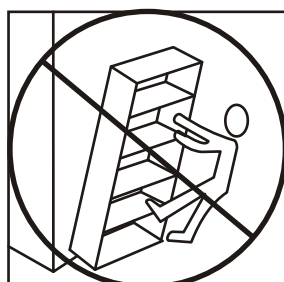
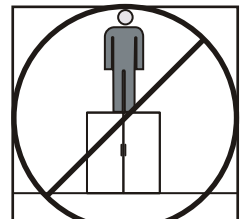
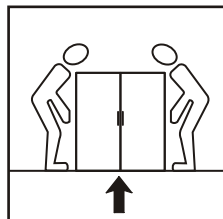
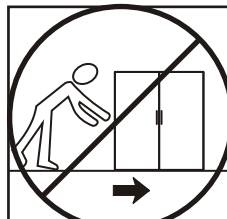
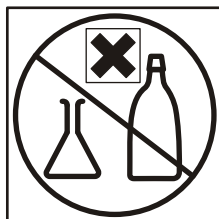
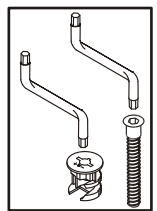
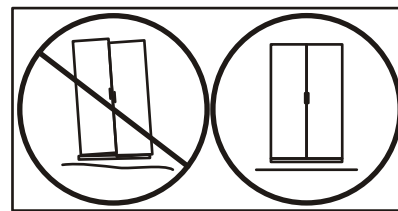
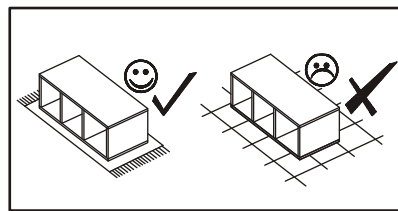
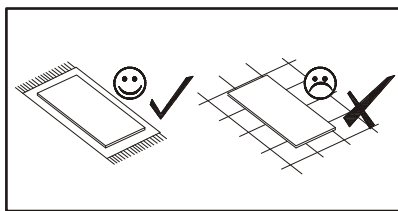
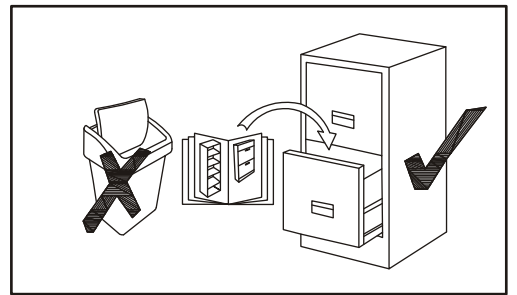
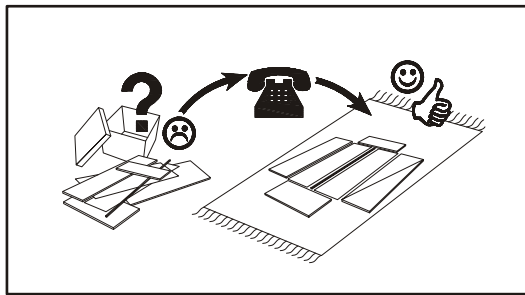
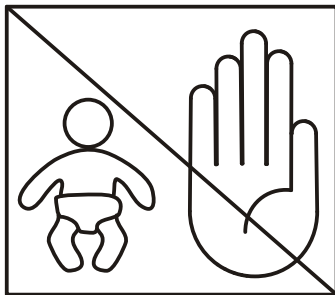
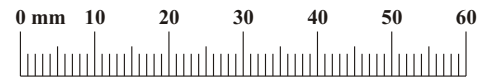
A1 x16  ø8x36	B4 x16 	B5 x16  ø15x12	G5 x16 	G20 x4 	G2 x1 
E1 x4 Ø26 H=0 	E2 x4 H=0 	S1 x12 	D6 x8 USØ3,5x30 	D10 x16 USØ3,5x13 	G21 x2 
ZR1 x4 	KR2 x4 	D7 x6 USØ3x16 	T1 x2 	LED x1 x1 	

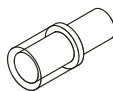
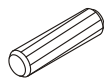

FLY TYP-33

G20		A1		B5	
x4		x16	ø8x36	x16	ø15x12

1

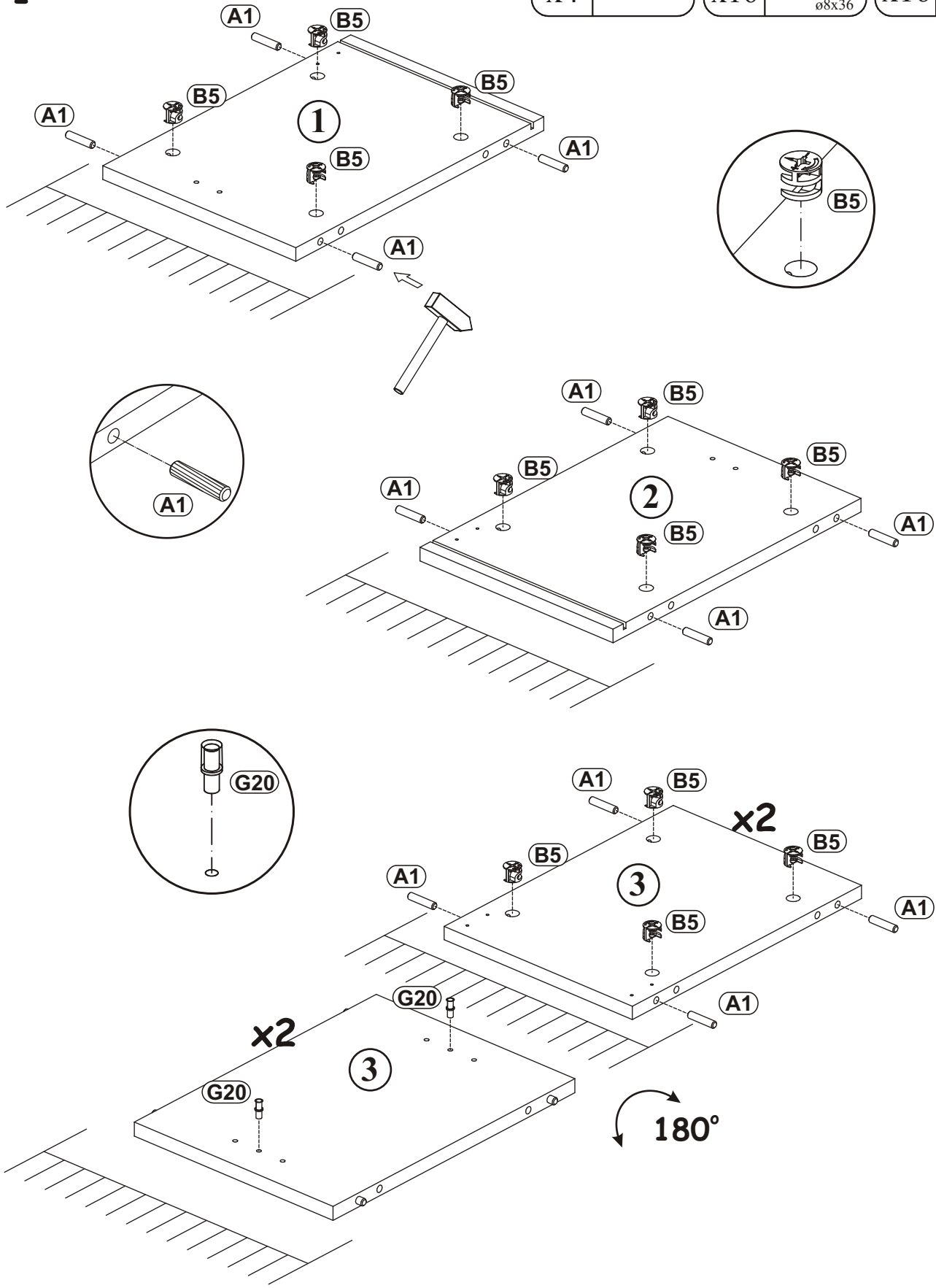

FLY TYP-33

2

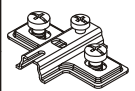
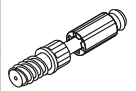
E2		B4	
x4	H=0	x16	

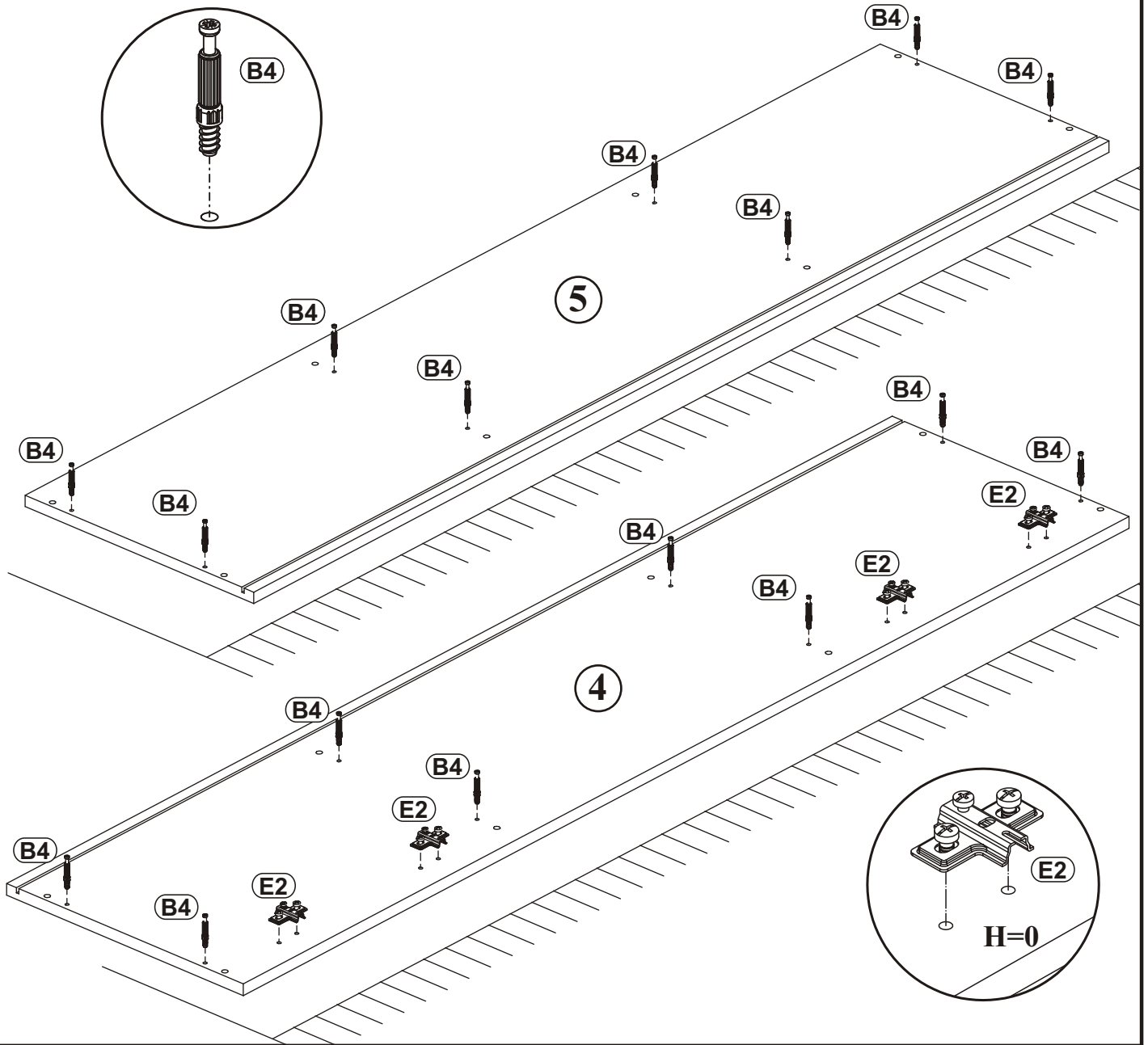

3

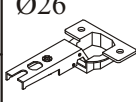
D10		E1	
x8	USØ3,5x13	x4	Ø26 H=0

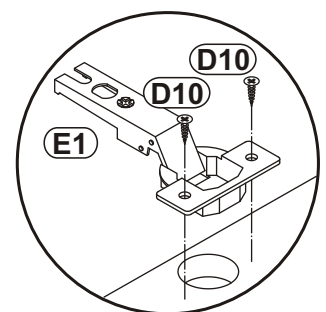
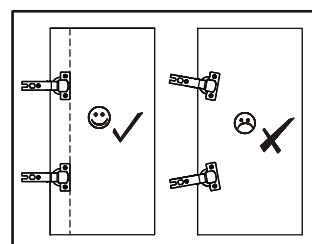
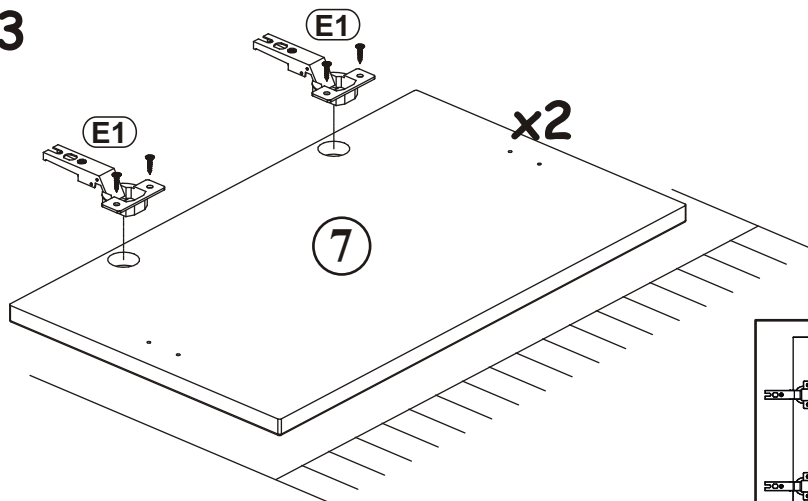

G5	
x16	

4

a)

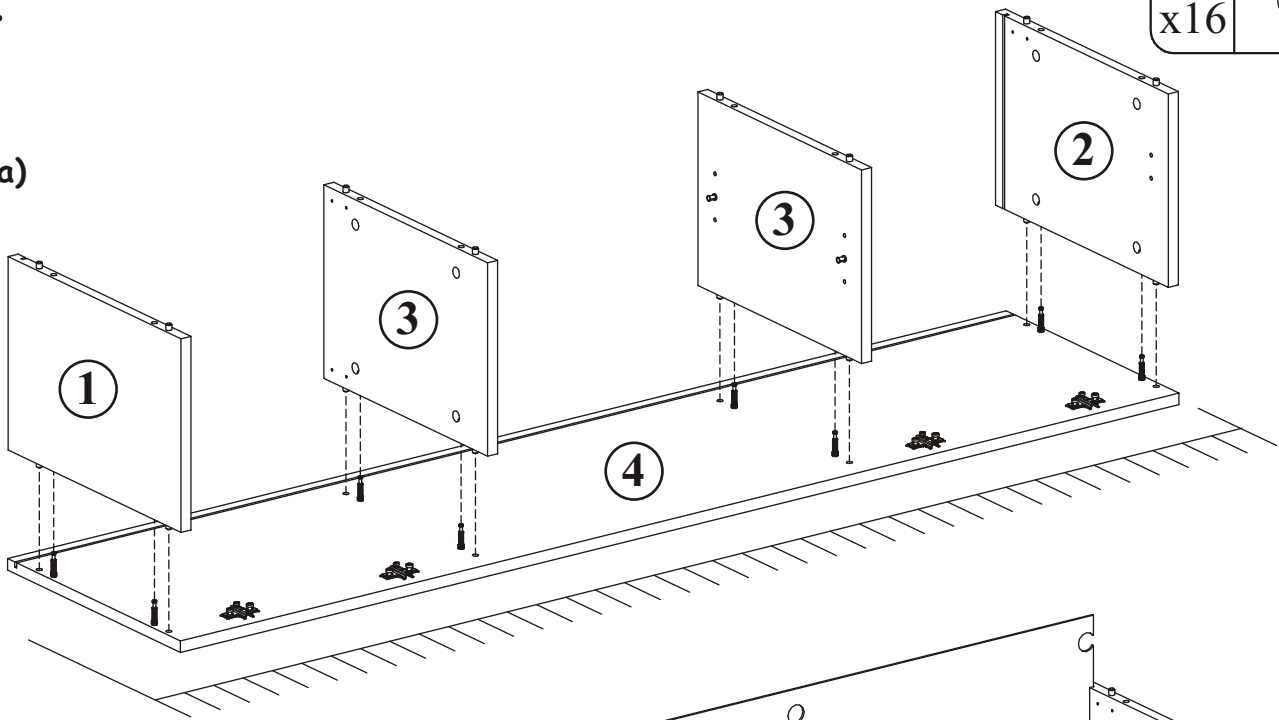

b)

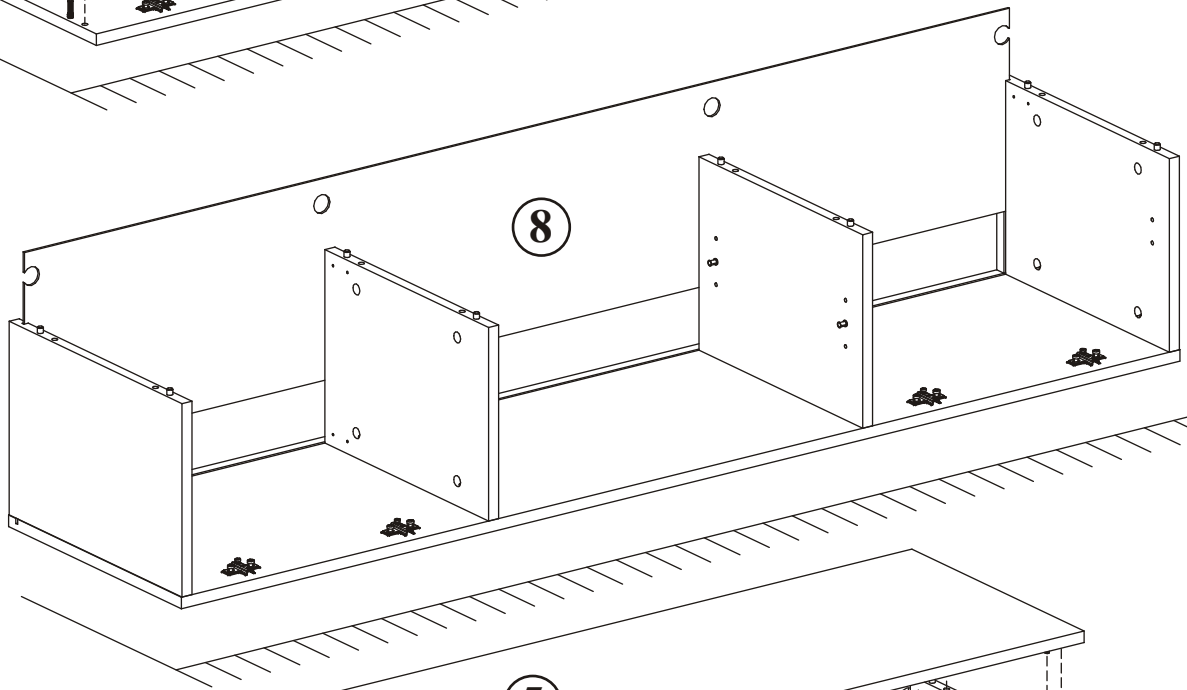

c)

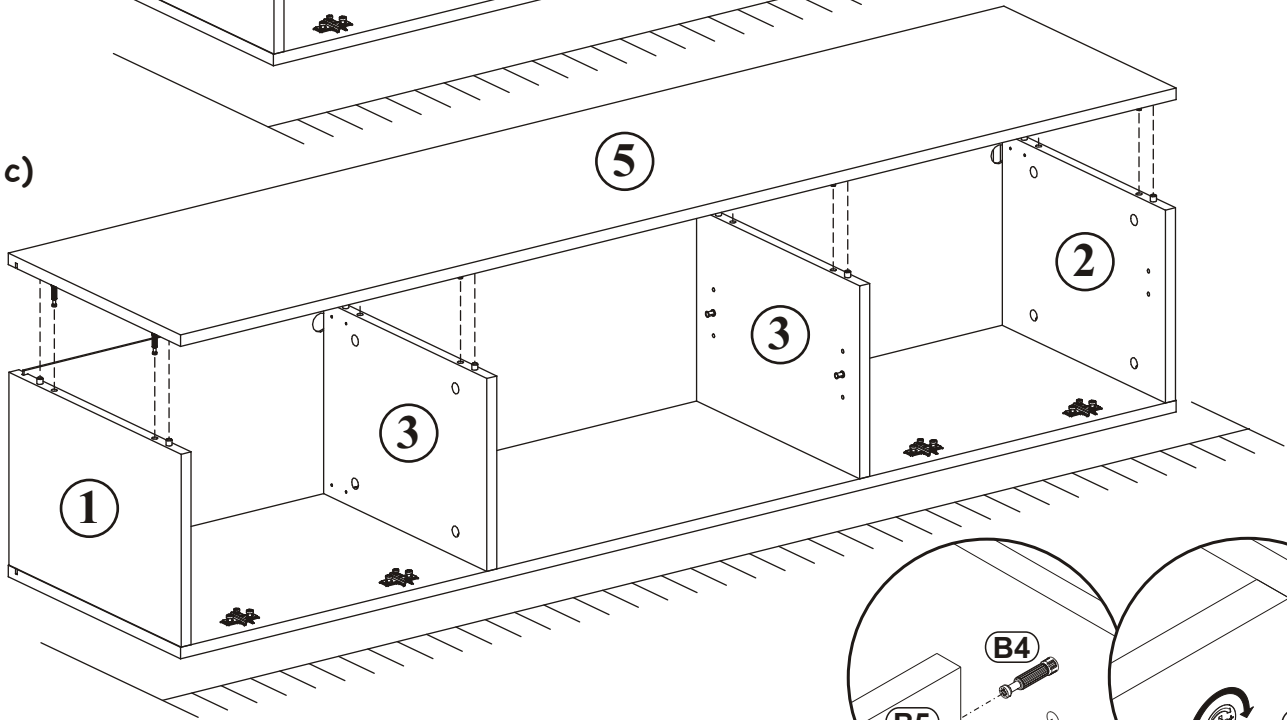

5

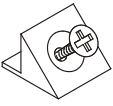
S1	
x12	

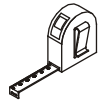

$X=Y$ 90°

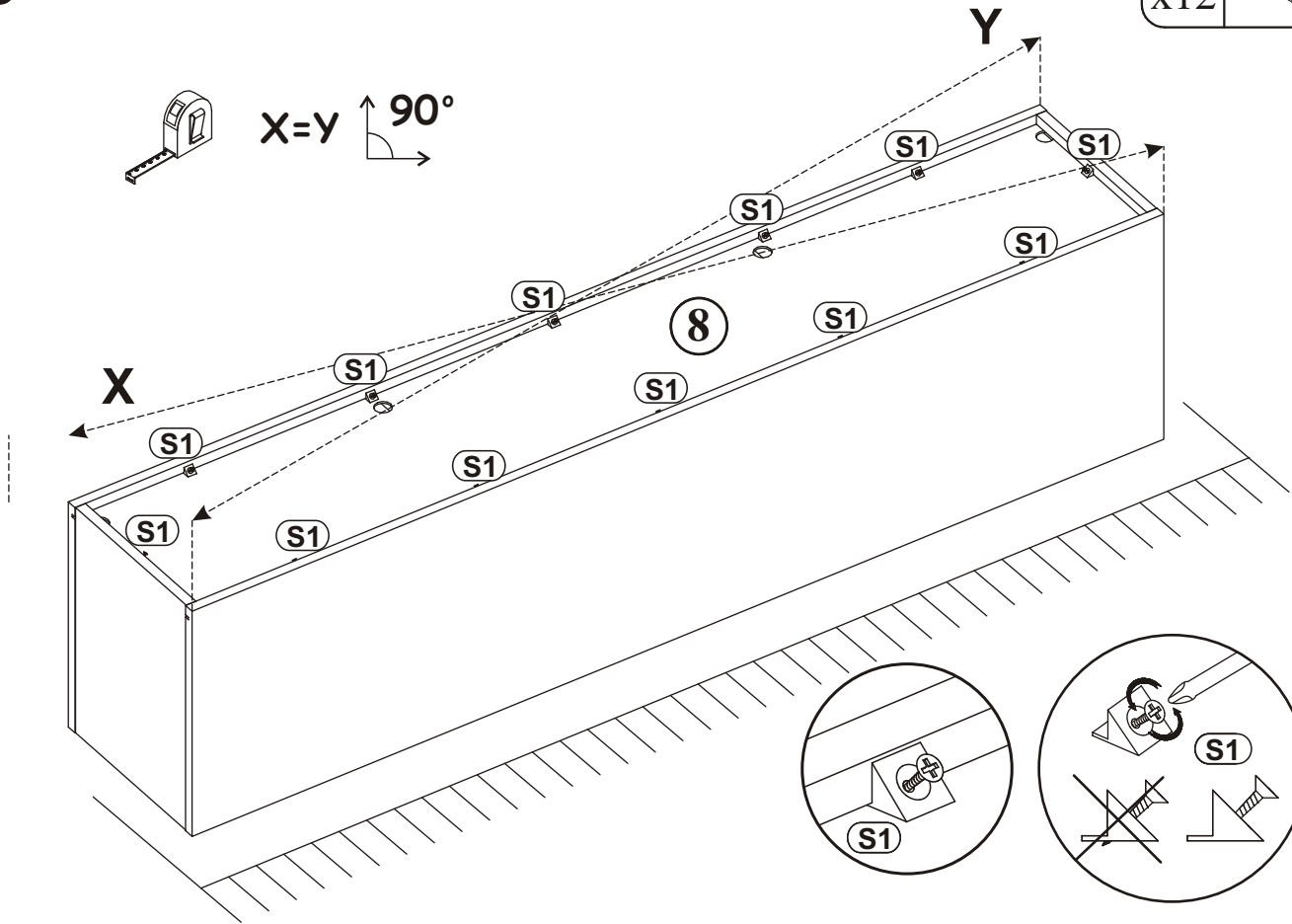

6

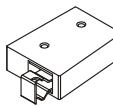
ZR1	
x4	

D6	
x8	USØ3,5x30

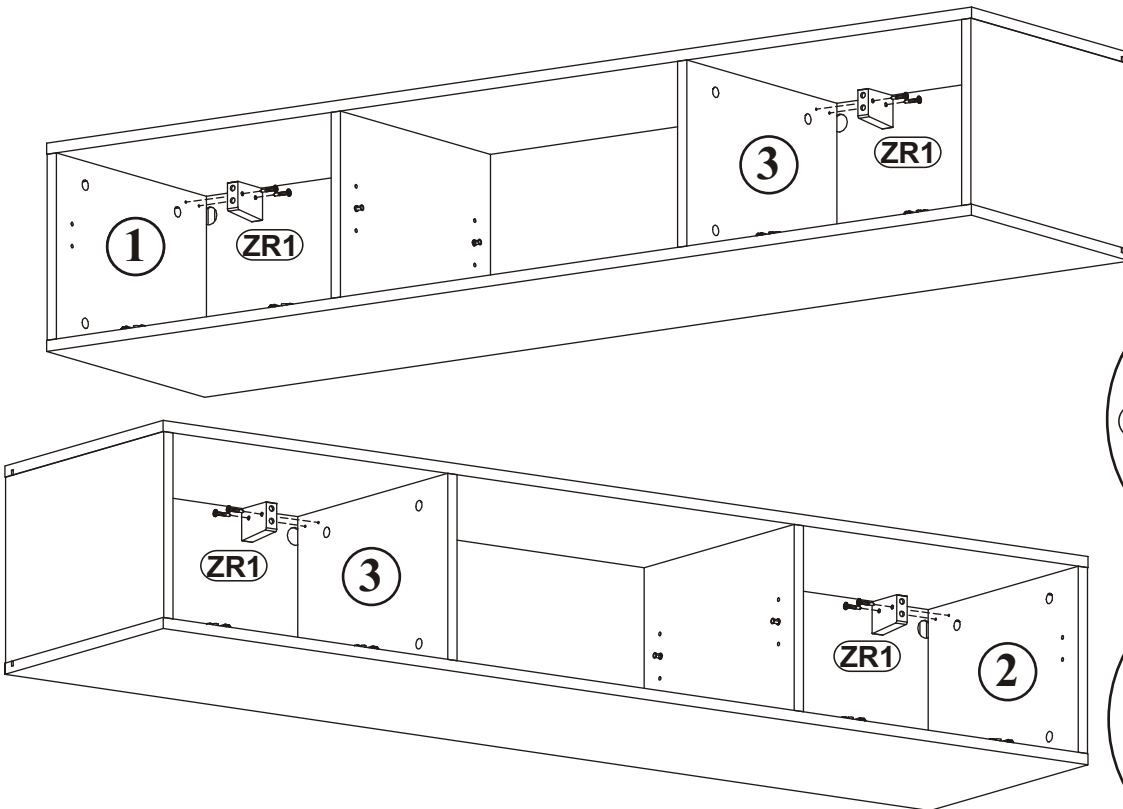

FLY TYP-33

7

T1		LED		D10	
x2		x1	x1	x4	USØ3,5x13

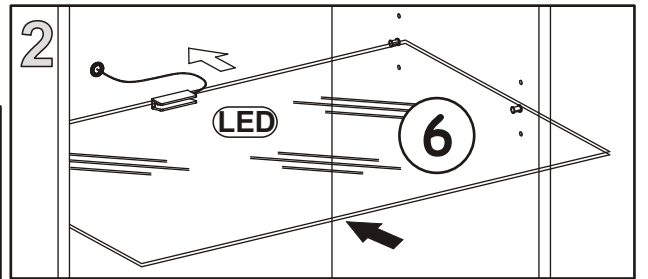
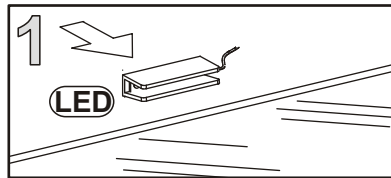
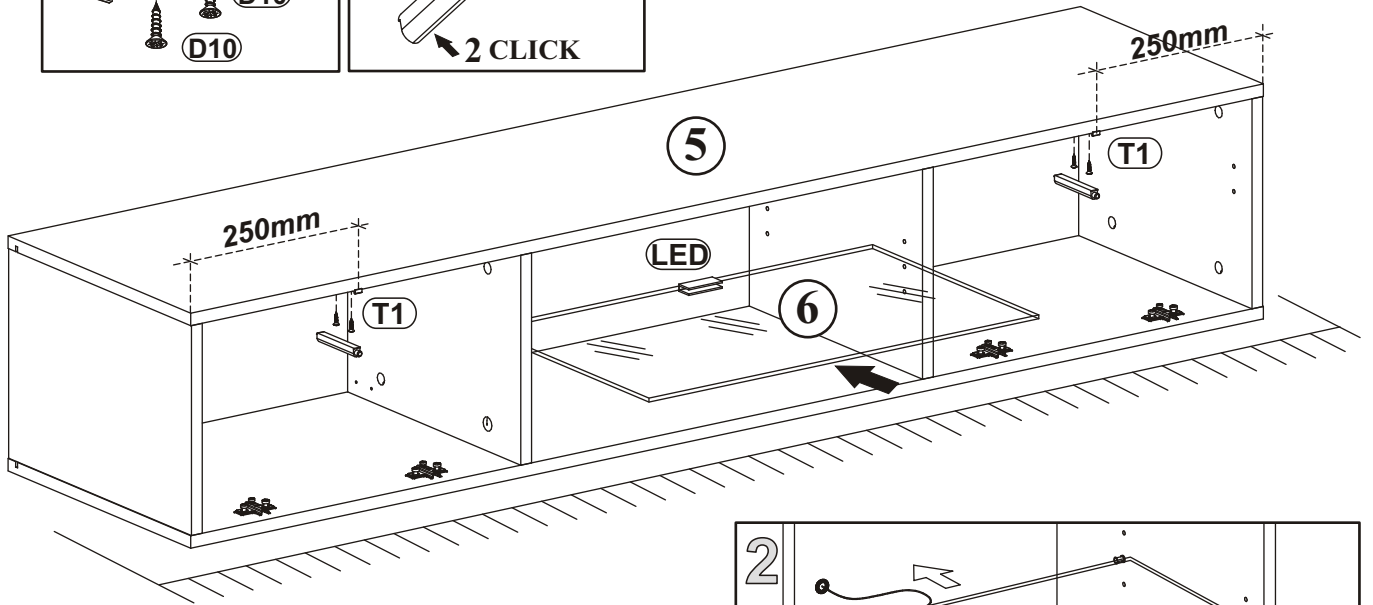
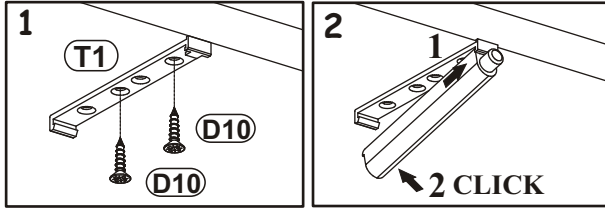

8

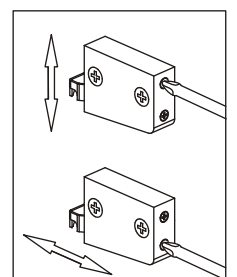
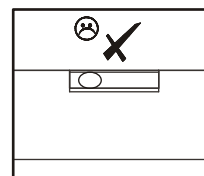
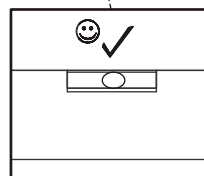
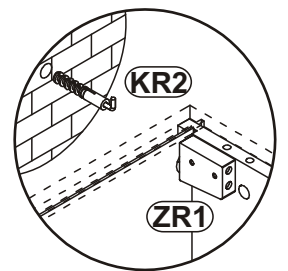
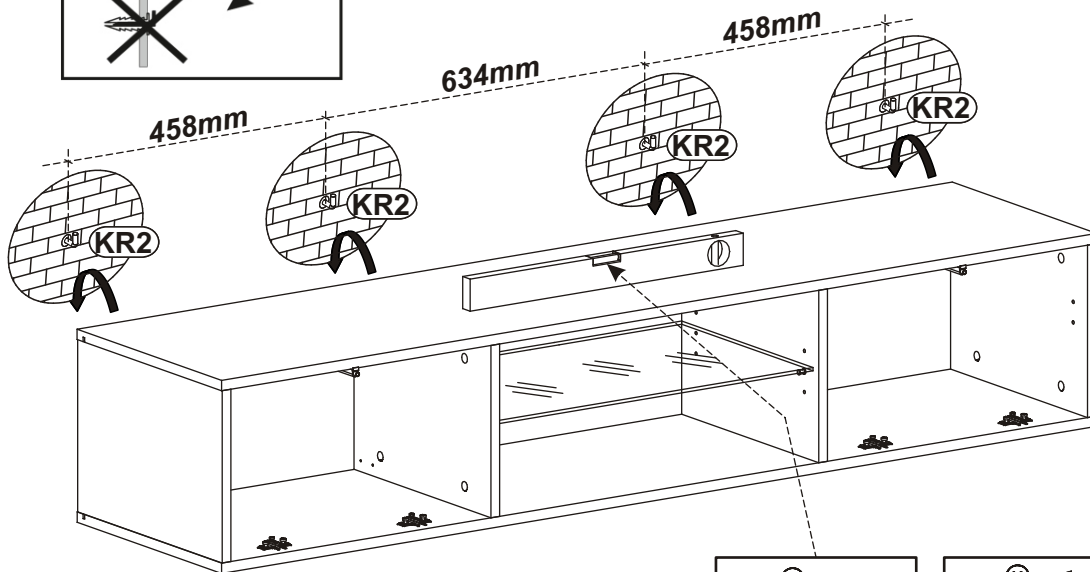
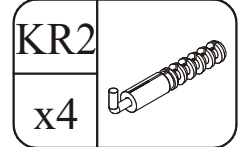
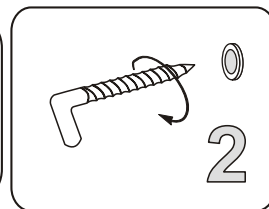
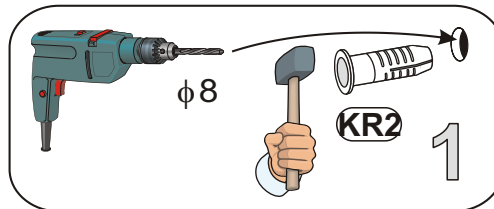
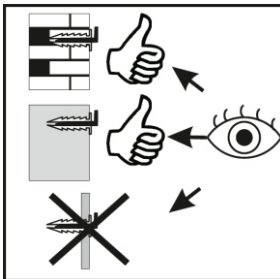

9

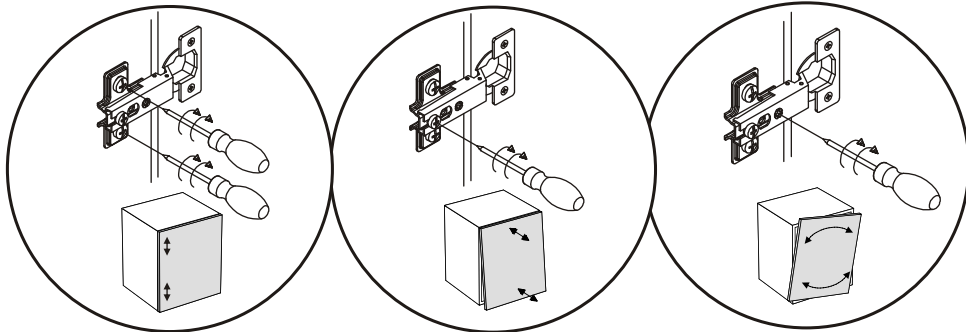
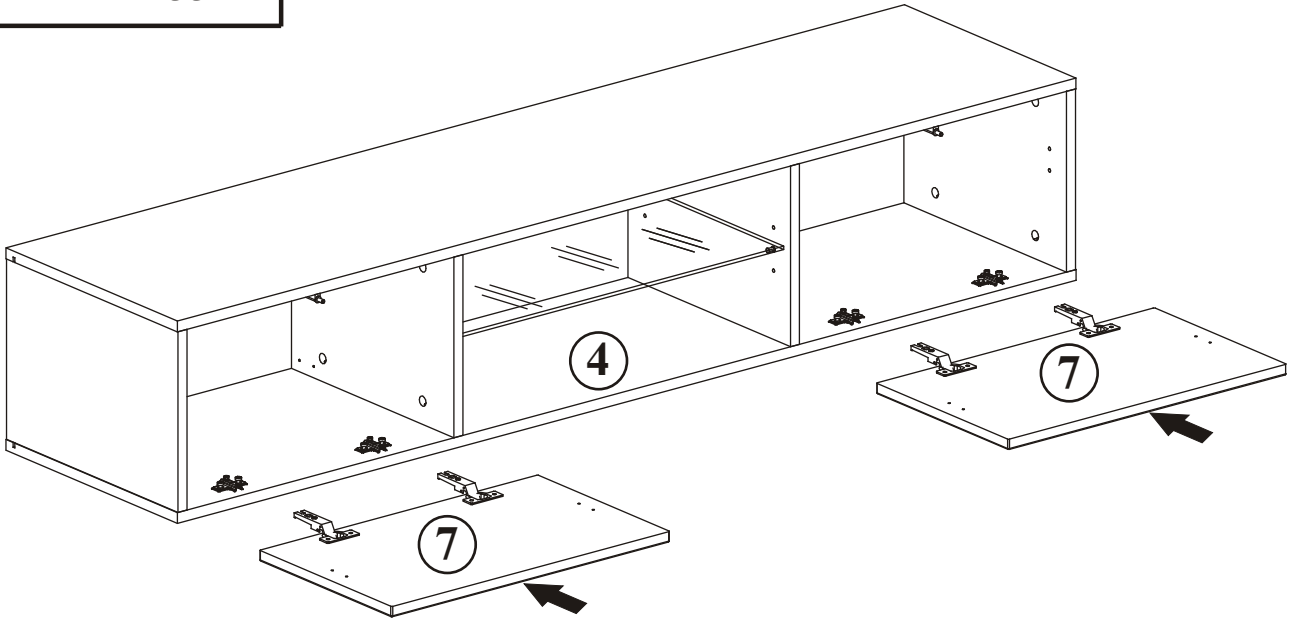

10

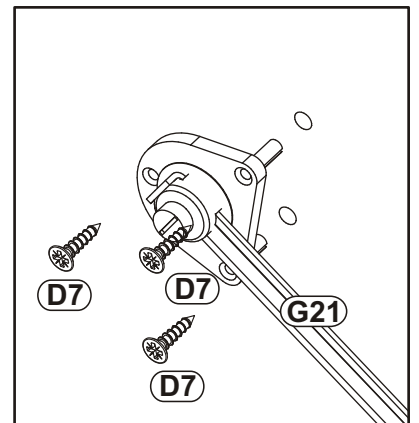
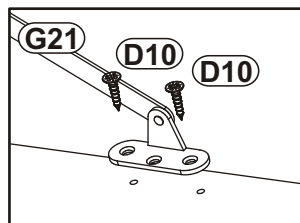
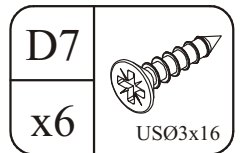
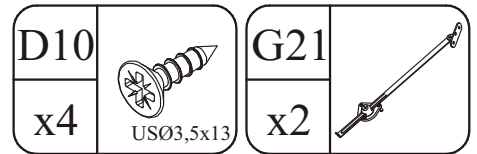
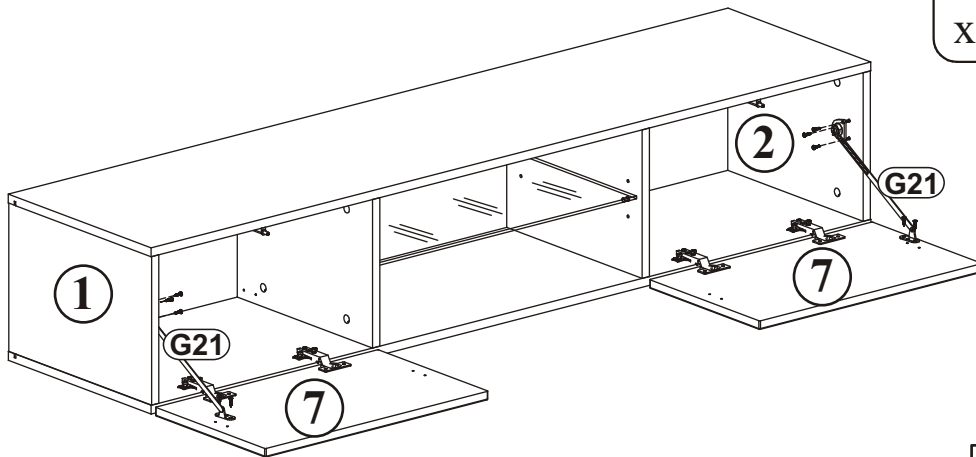



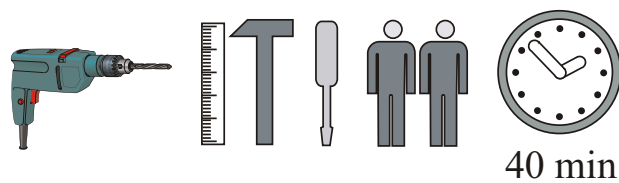
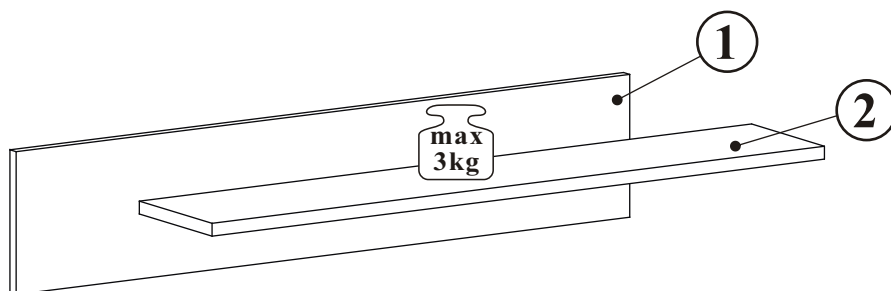
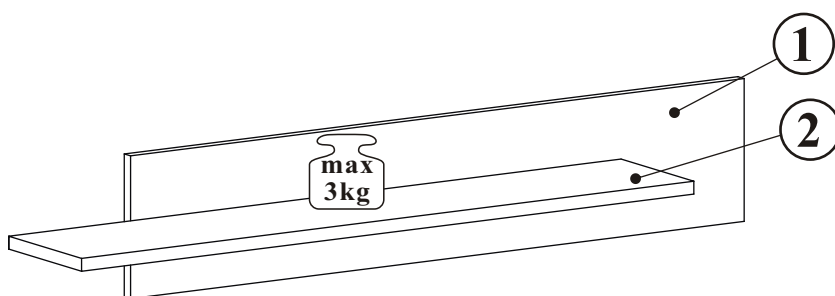
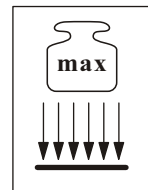
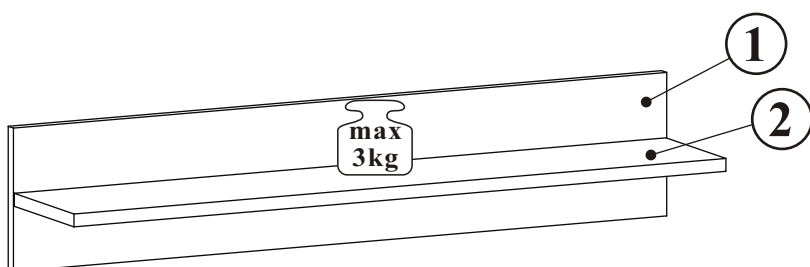



GALINO 23_MX

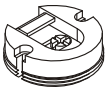

NO	Dim.		Col.-No	Qty
1	1002	200	1	2
2	1000	185	1	2

GALINO 23_MX

ZM1 x4		D20 x8	 ESØ6x9,5	B11 x12	 Ø7x50	G4 x12		KR2 x4		G2 x1	
-----------	---	-----------	---	------------	--	-----------	---	-----------	---	----------	---

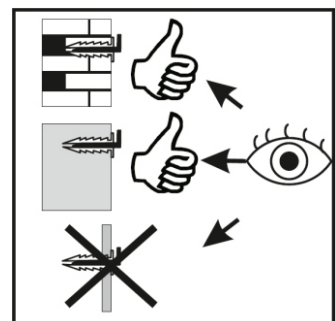
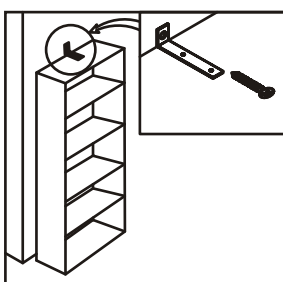
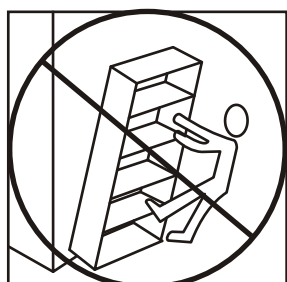
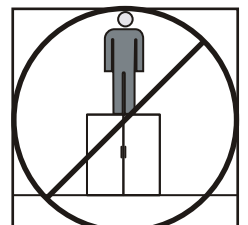
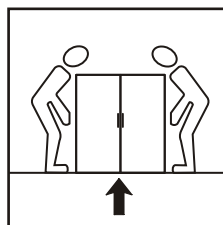
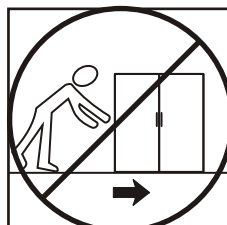
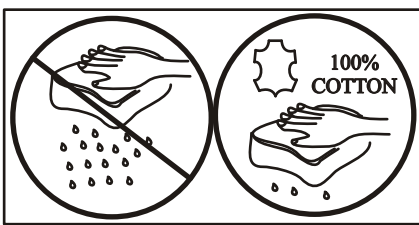
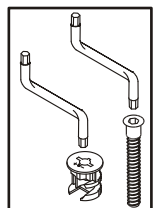
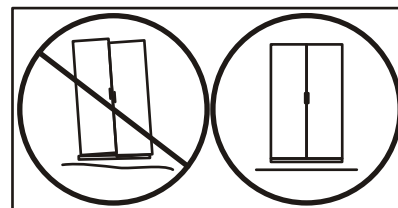
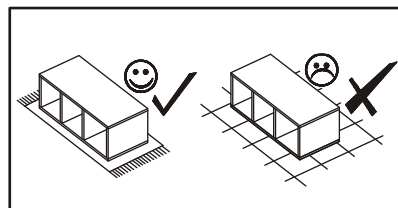
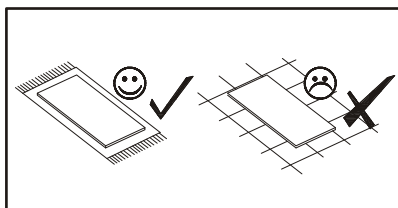
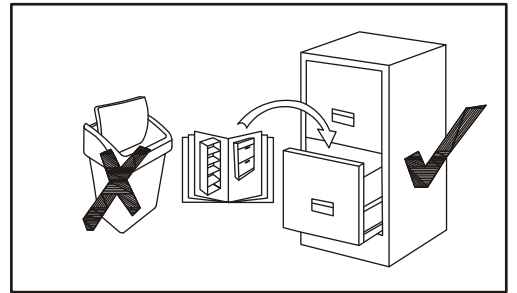
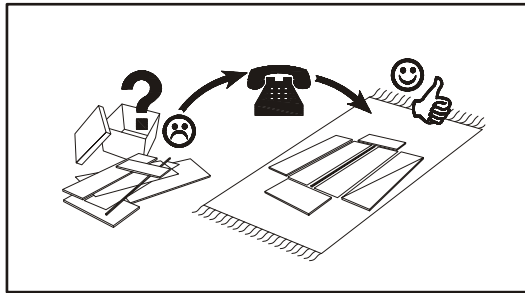
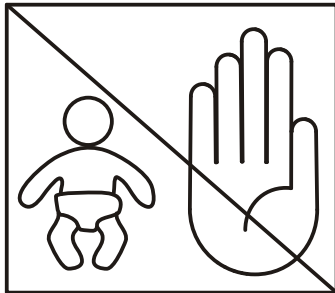
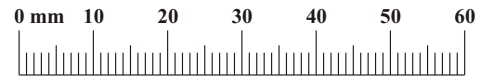

1-3

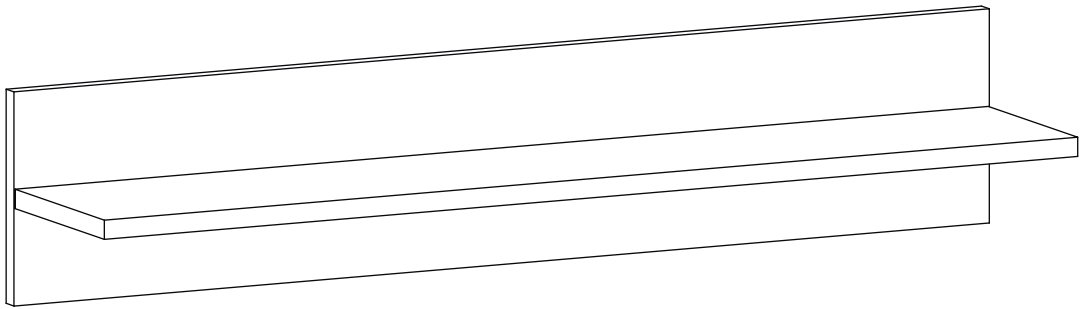

4-6

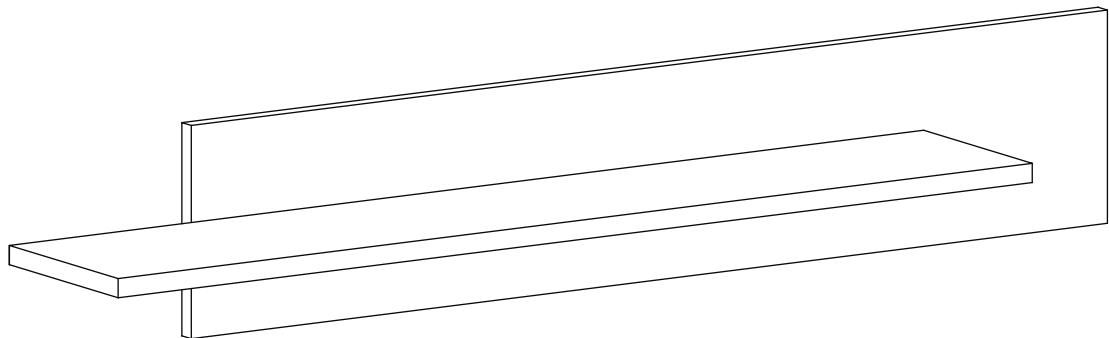

7-9

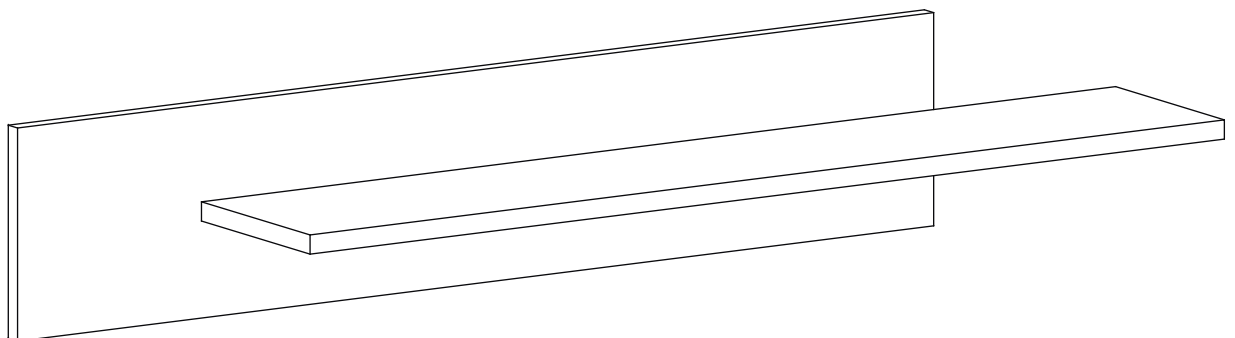

GALINO 23_MX

1

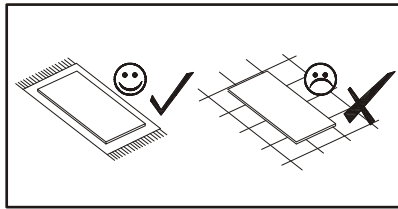

ZM1
x4

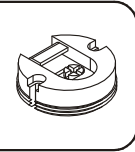

D20
x8

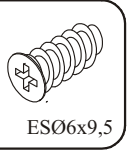

ESØ6x9,5

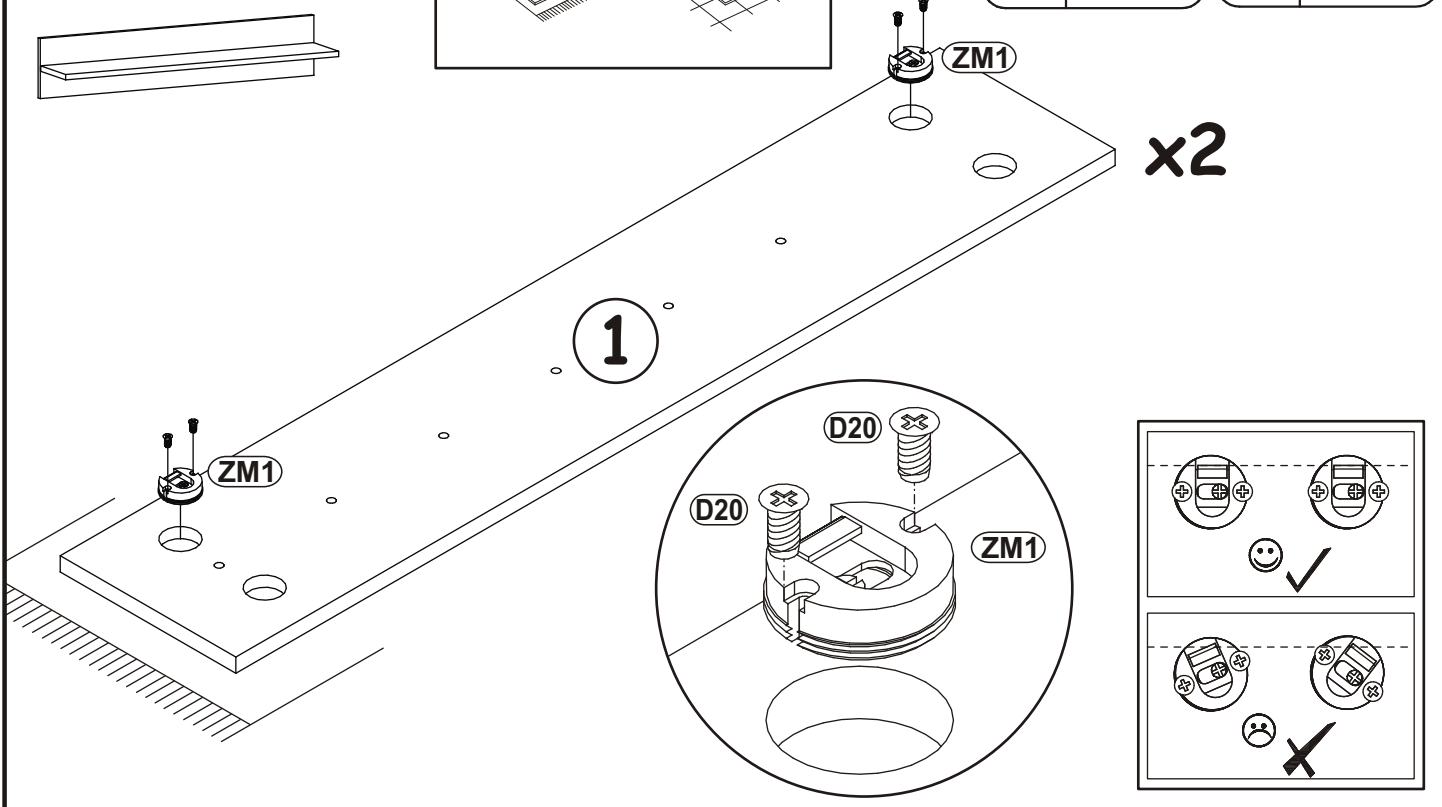

2

B11
x12

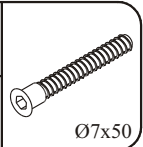

Ø7x50

G4
x12

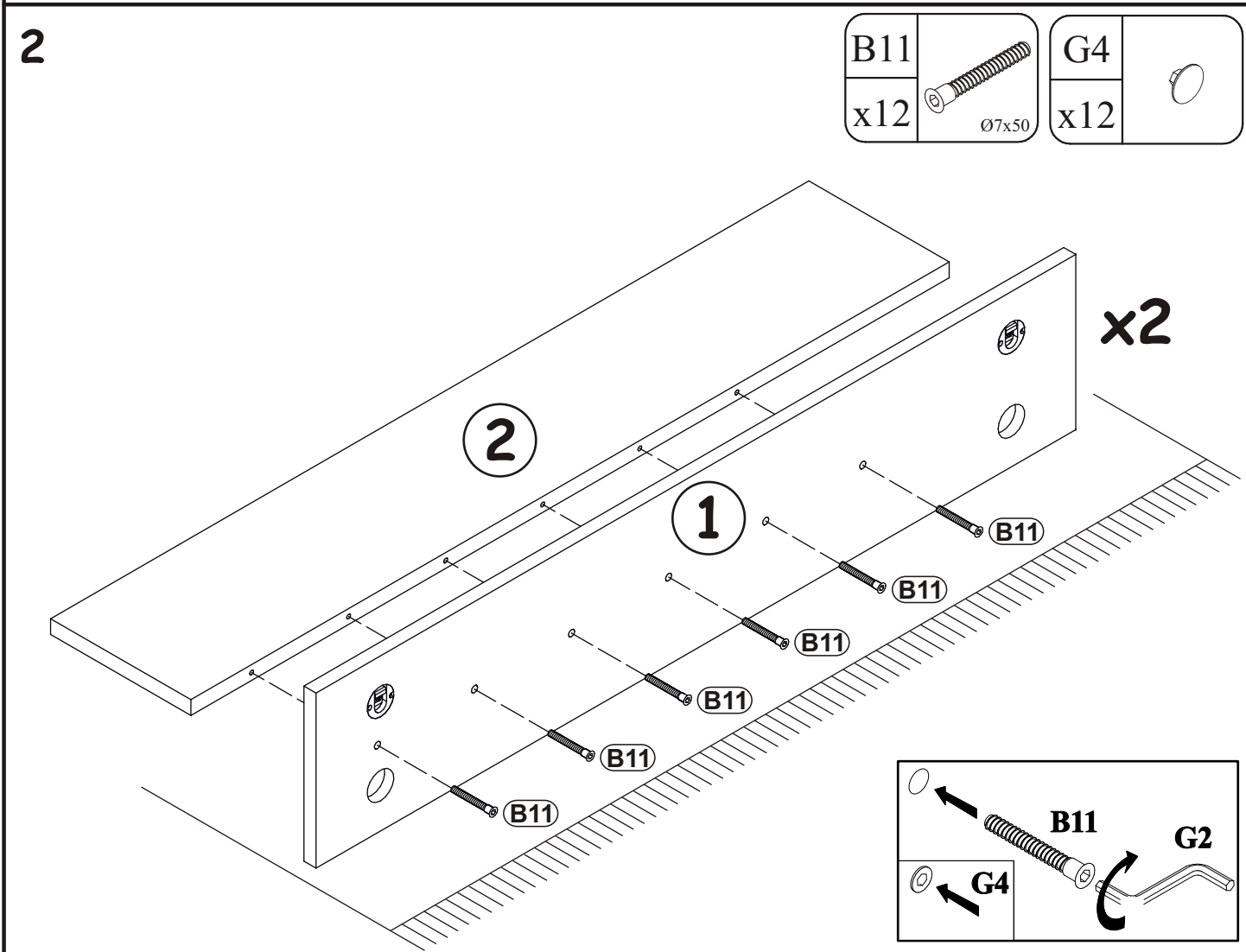
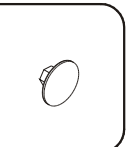

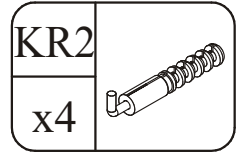

3

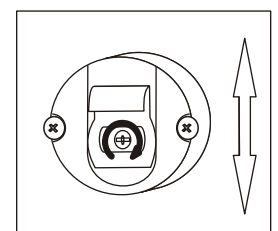
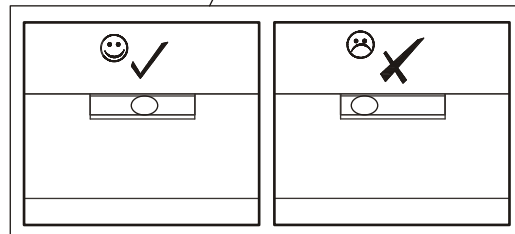
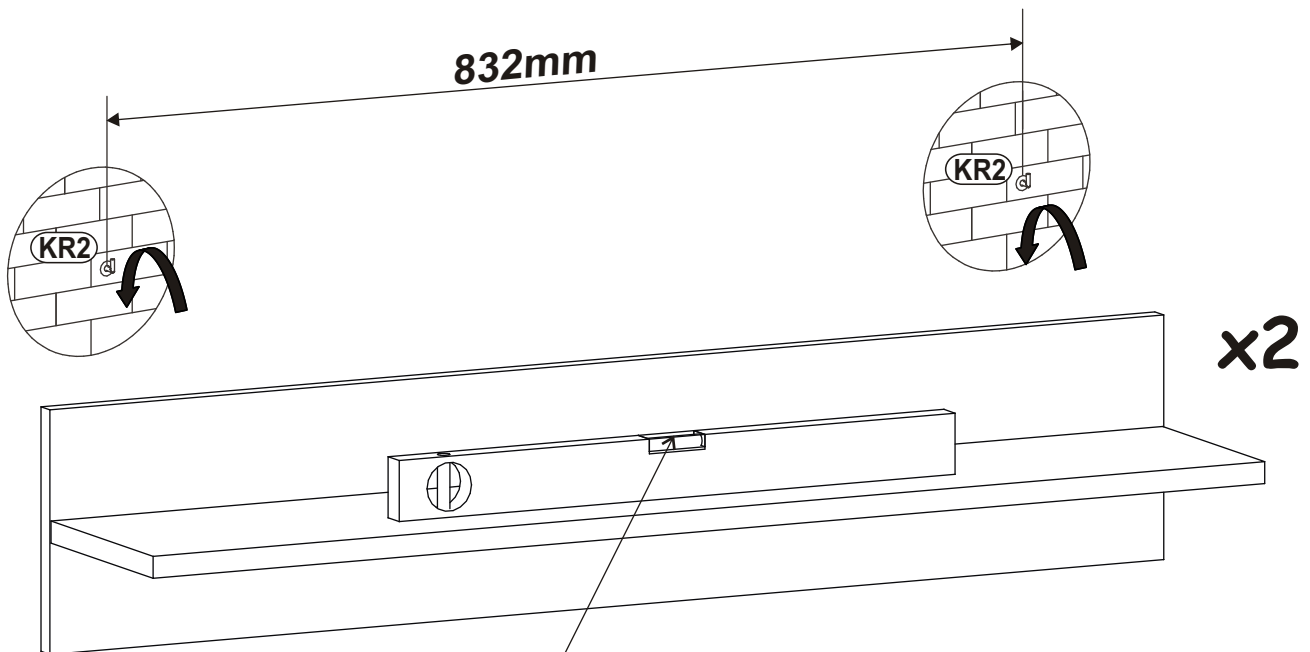
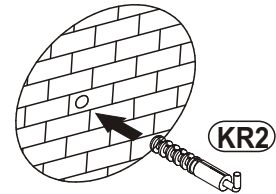
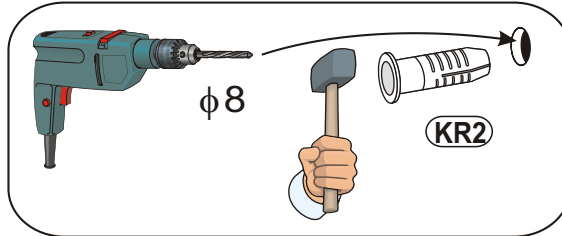
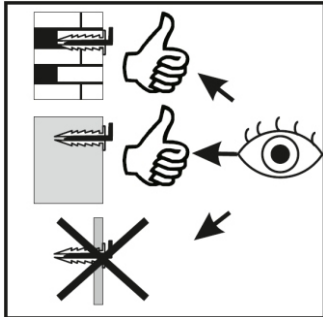

4

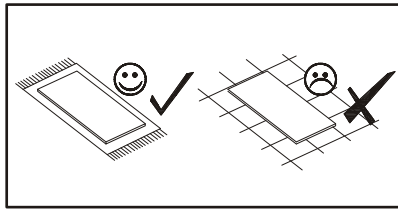

ZM1		D20	
x4		x8	ESØ6x9,5

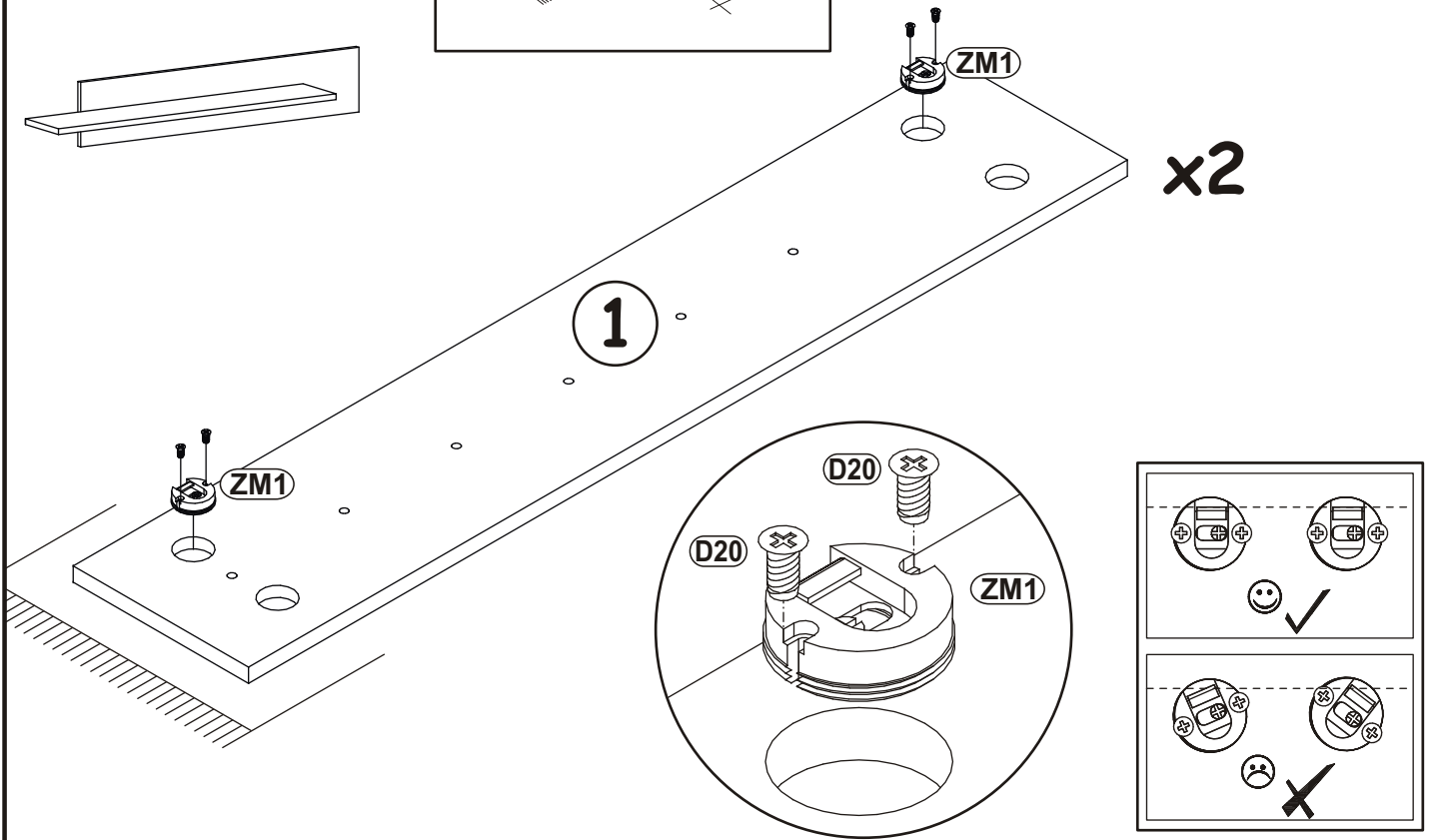

5

B11		G4	
x12	Ø7x50	x12	

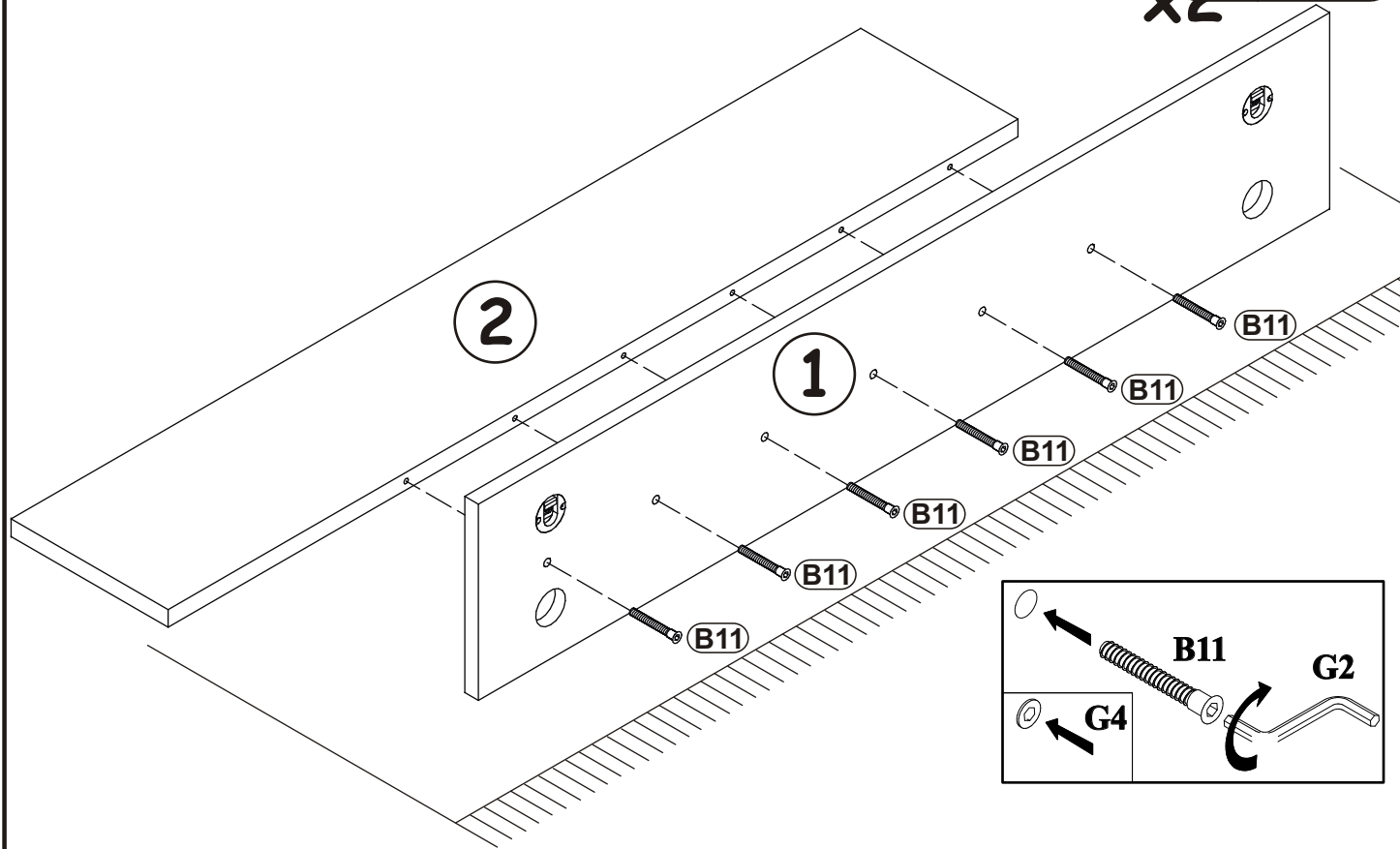

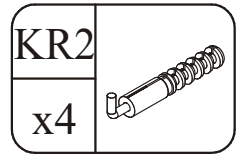

6

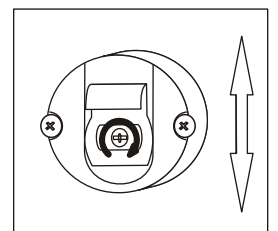
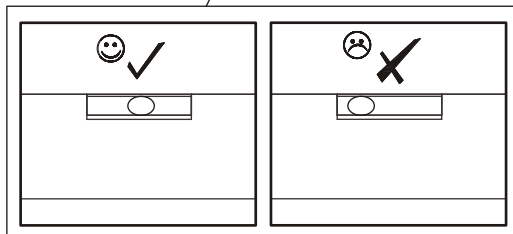
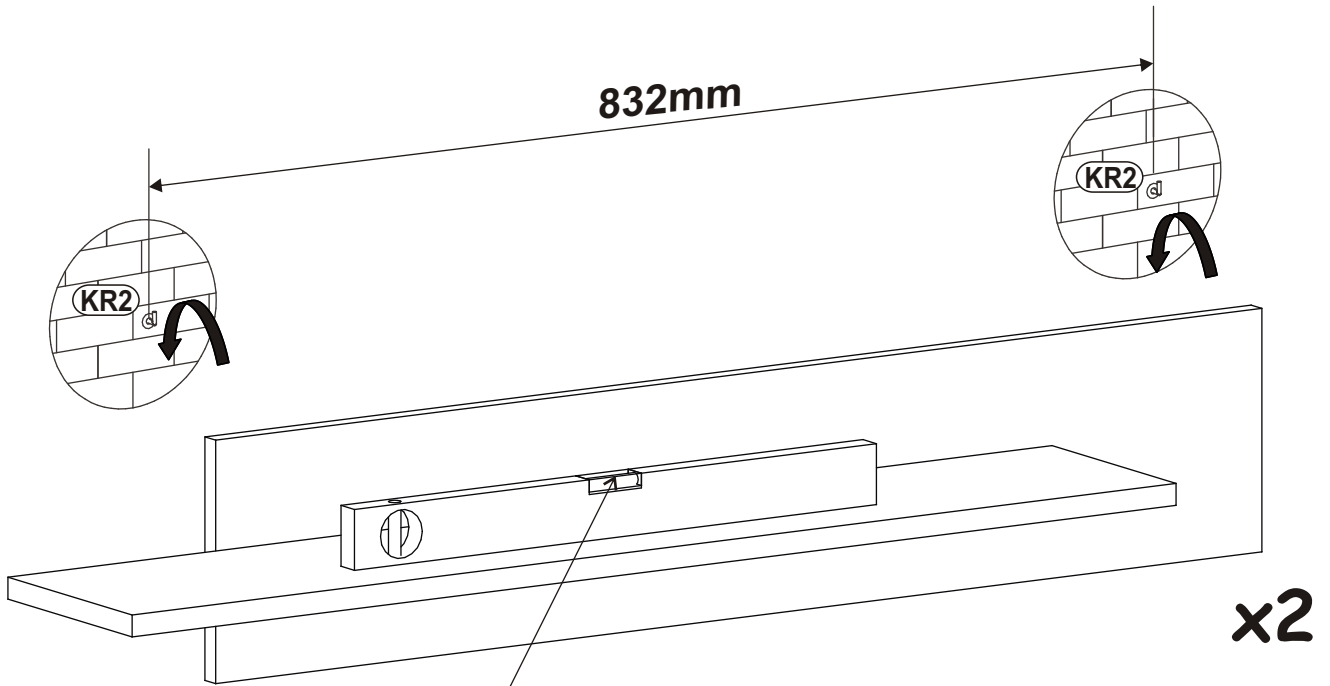
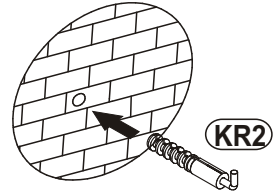
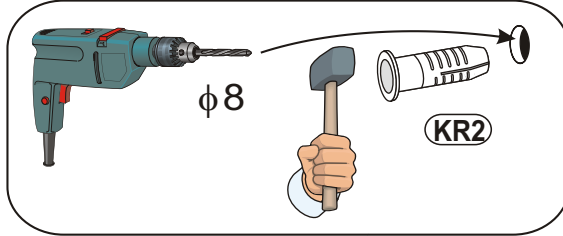
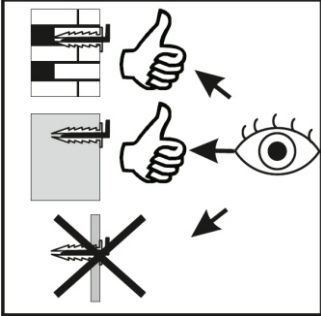

7

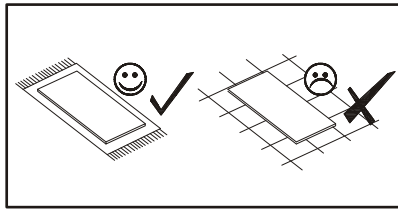

ZM1		D20	
x4		x8	

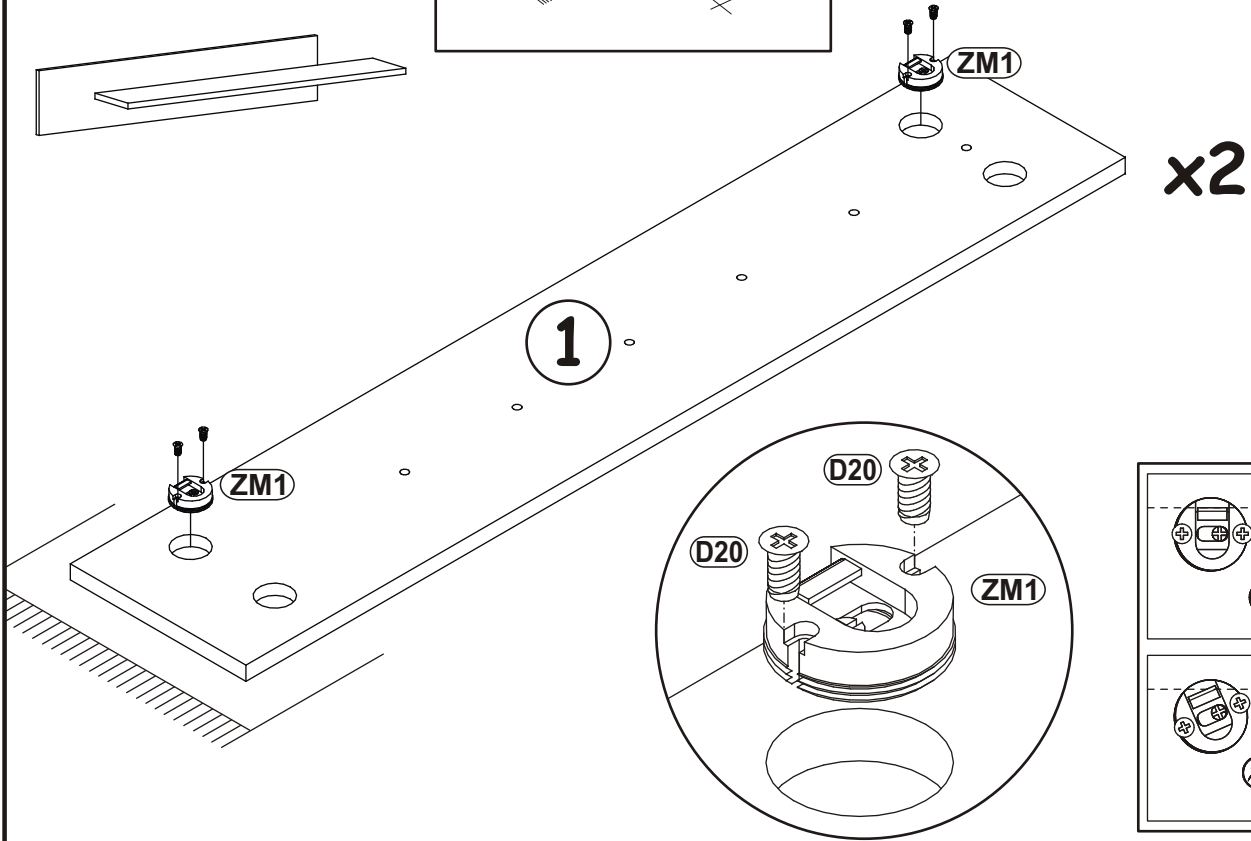

8

B11		G4	
x12	Ø7x50	x12	

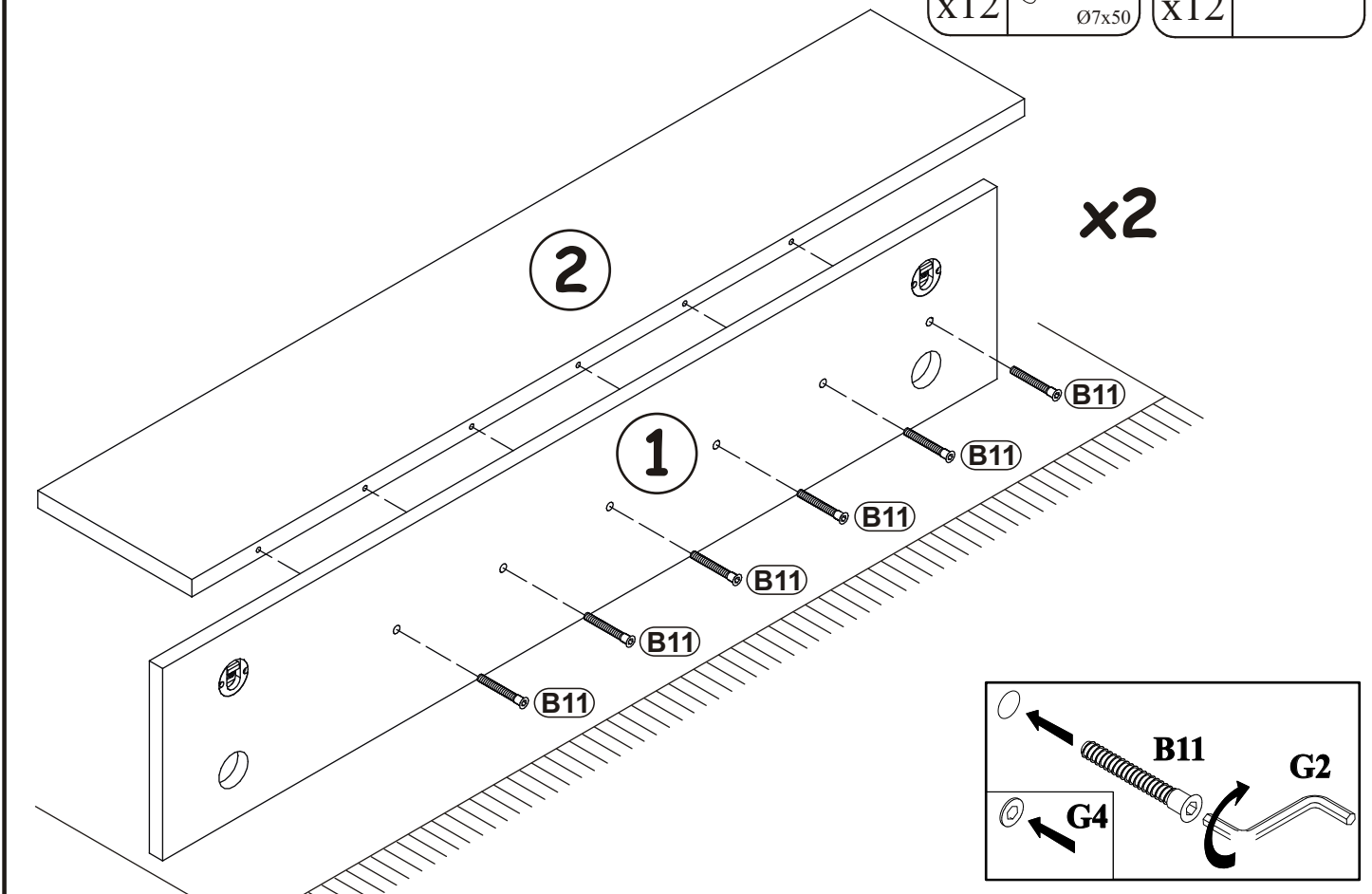

9

