

# PEDRO HJZ PD \_\_\_ TYP F

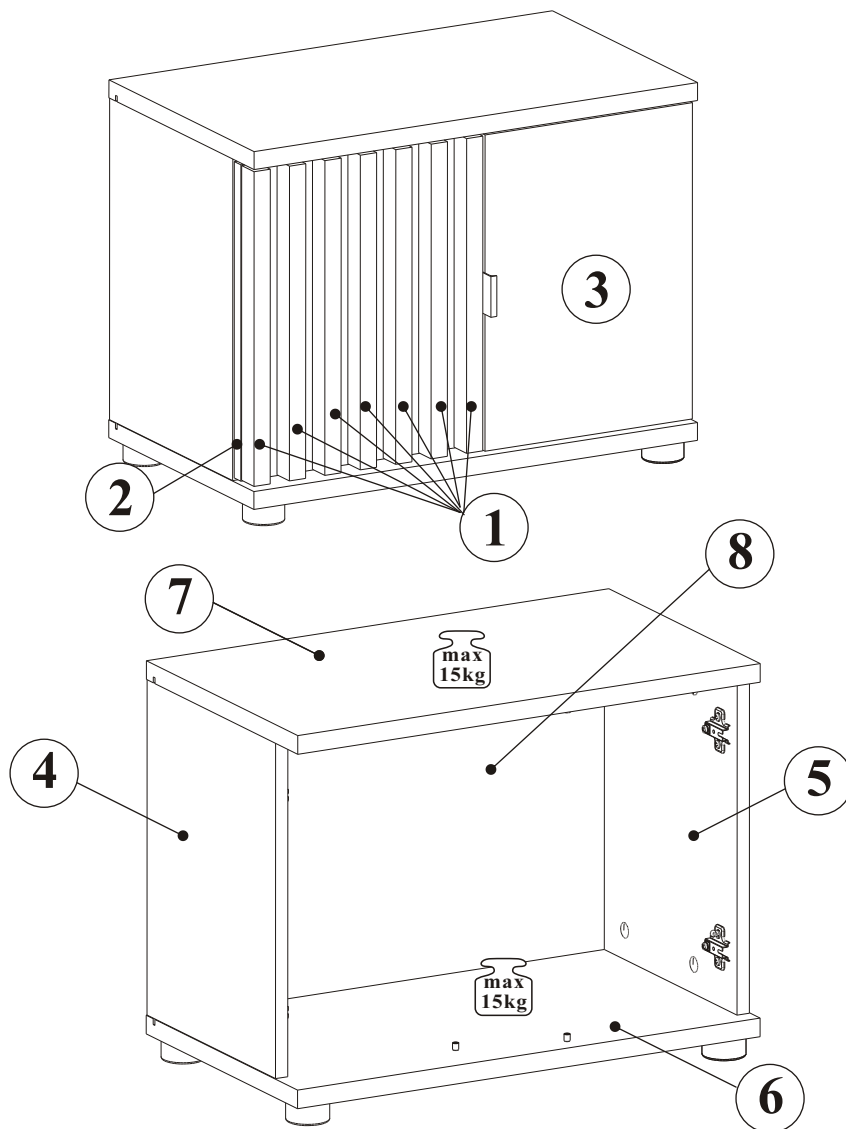

NO	DIM [mm]		COL.-NO	QTY
1	387	30	22 1/1	7
2	312	389	16 1/1	1
3	281	389	16 1/1	1
4	396	297	16 1/1	1
5	396	327	16 1/1	1
6	601	350	22 1/1	1
7	601	350	22 1/1	1
8	408	579	3 1/1	1

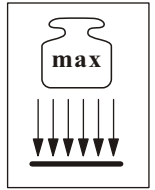

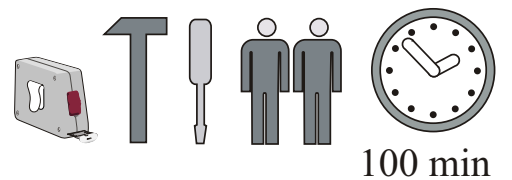

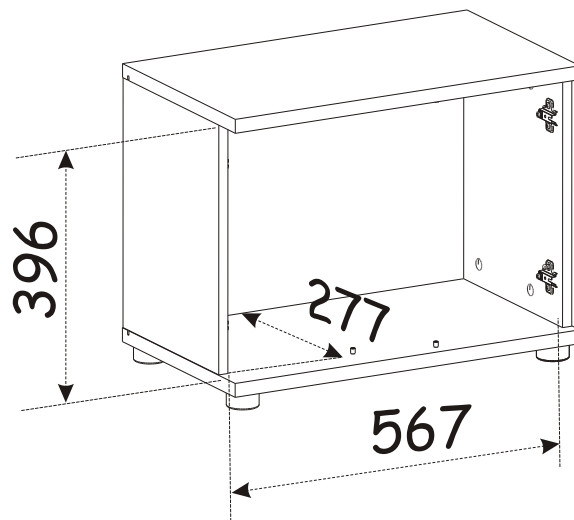
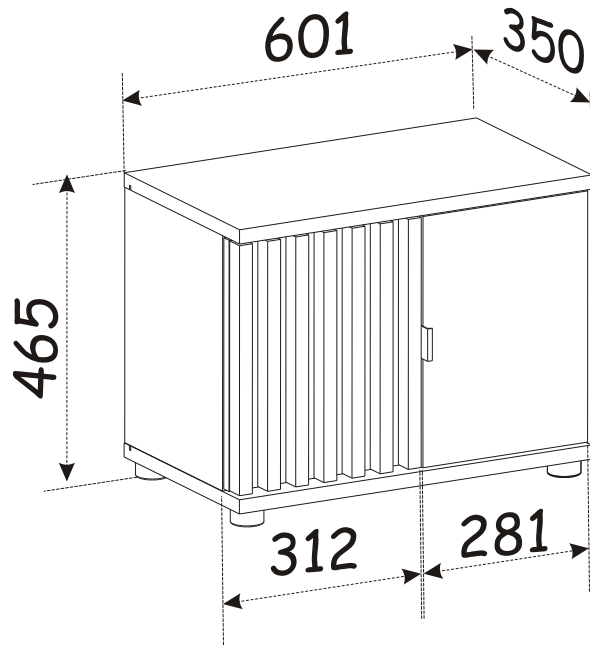

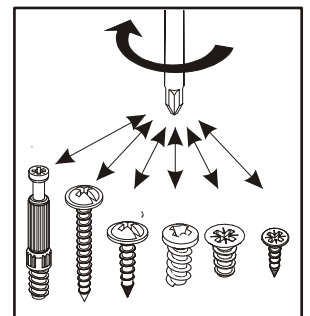
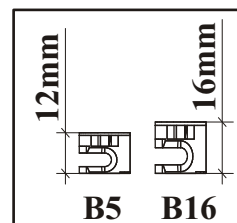
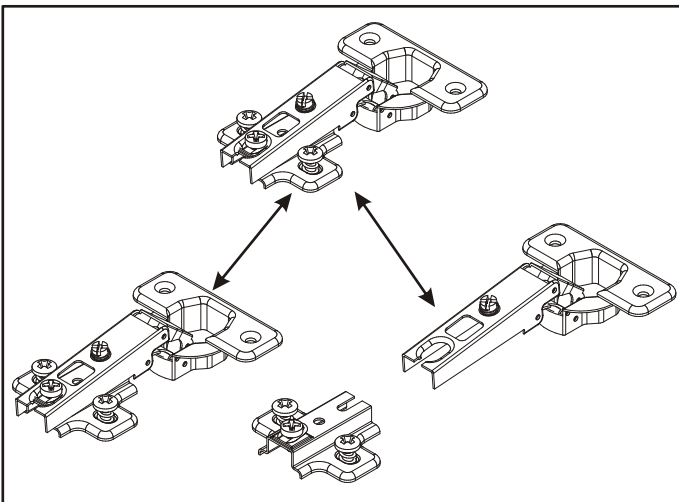
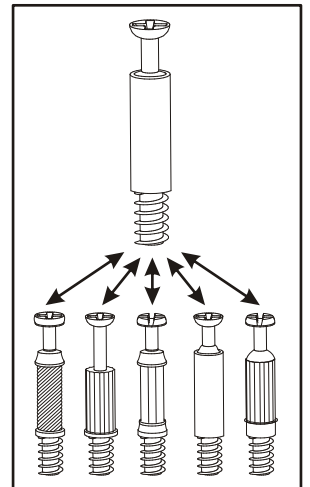
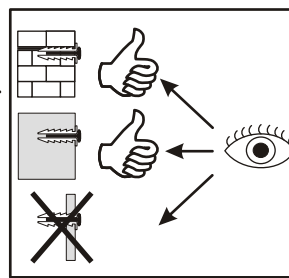
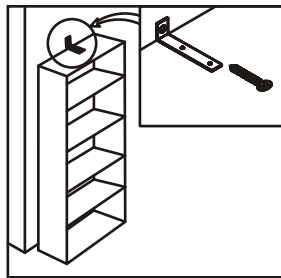
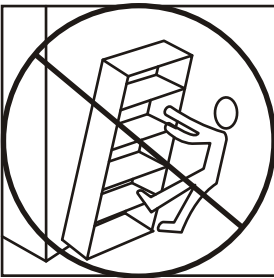
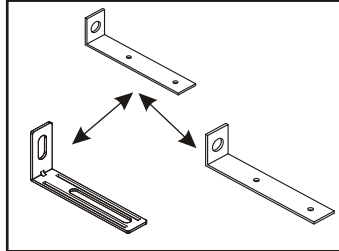
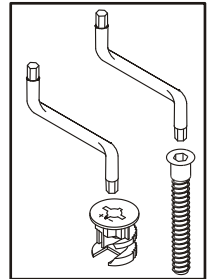
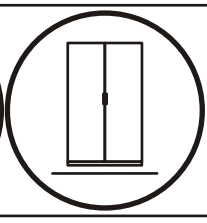
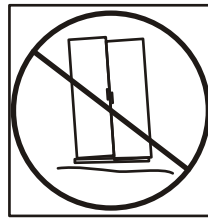
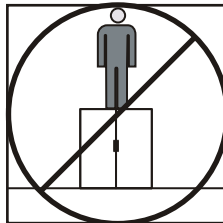
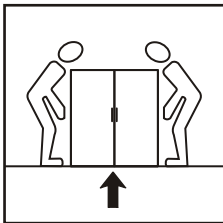
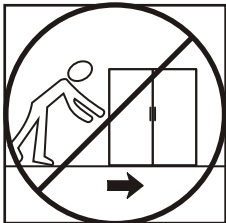
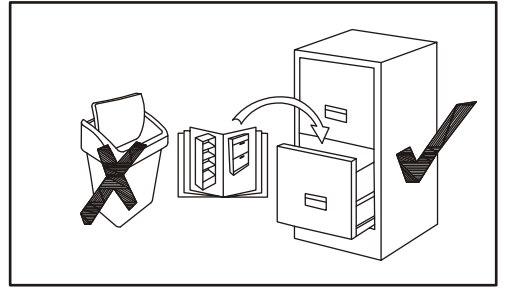
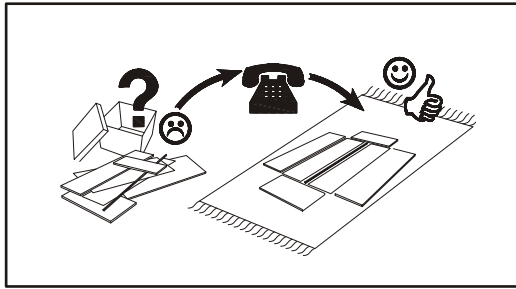
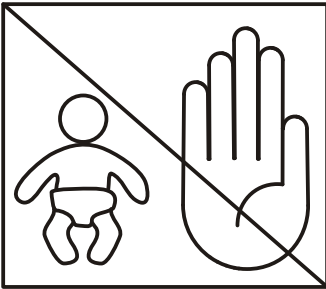
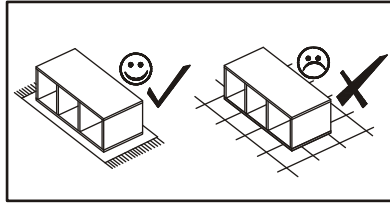
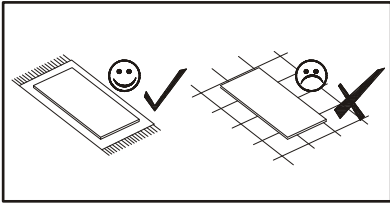

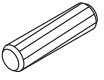

# PEDRO HJZ PD \_ TYP F

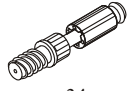

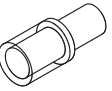
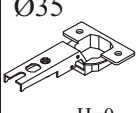
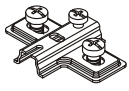
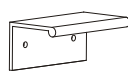
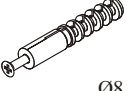
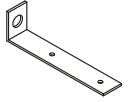
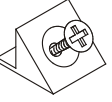
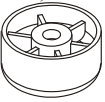

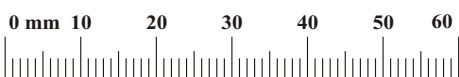

PEDRO HJZ PD \_ TYP F

A1 x8  ø8x36	B22 x21  Ø7x40	G4 x18 	B4 x8  34	B5 x8  ø15x12	G5 x8 
G20 x4 	E21 x4  Ø35 H=0	E2 x4  H=0	G02 x1  L-32mm.	KR1 x2  Ø8	L1 x2 
S1 x6 	ST7 x4  Ø50, h=25	UP17 x4  UPØ4x25	D10 x14  USØ3,5x13	G2 x1 	G12 x3  Ø14

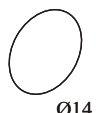

1

G12	
x3	Ø14

B22	
x21	Ø7x40

G4	
x18	

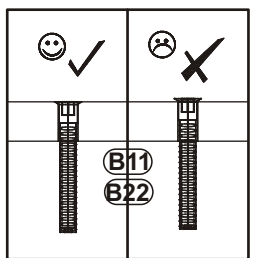
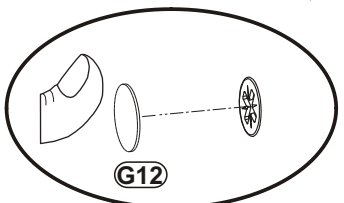
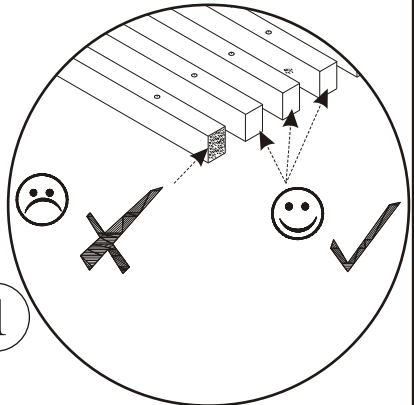
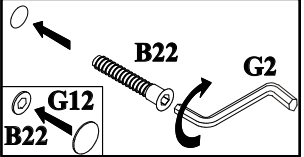
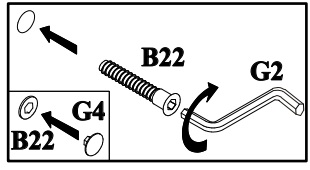
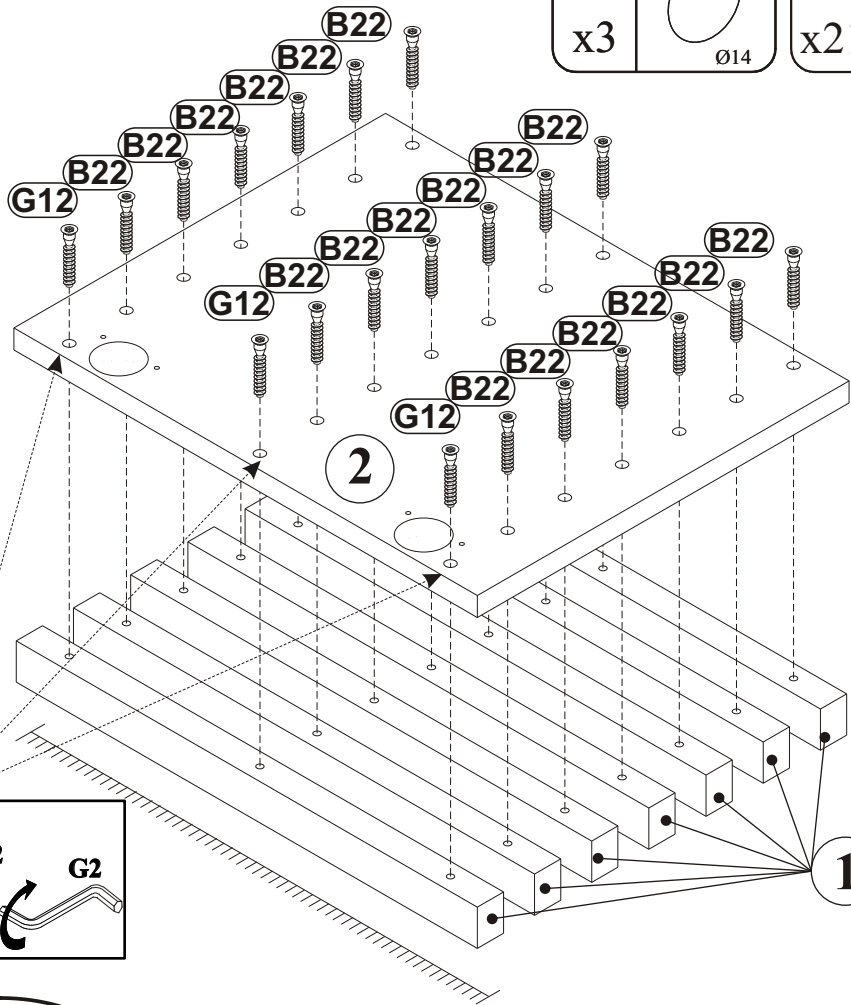

2

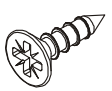
D10	
x4	USØ3,5x13

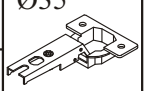
E21	
x2	Ø35 H=0

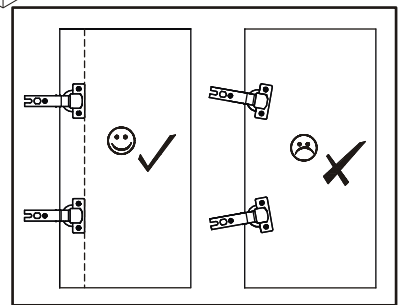
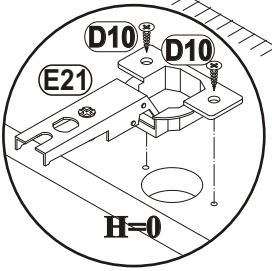
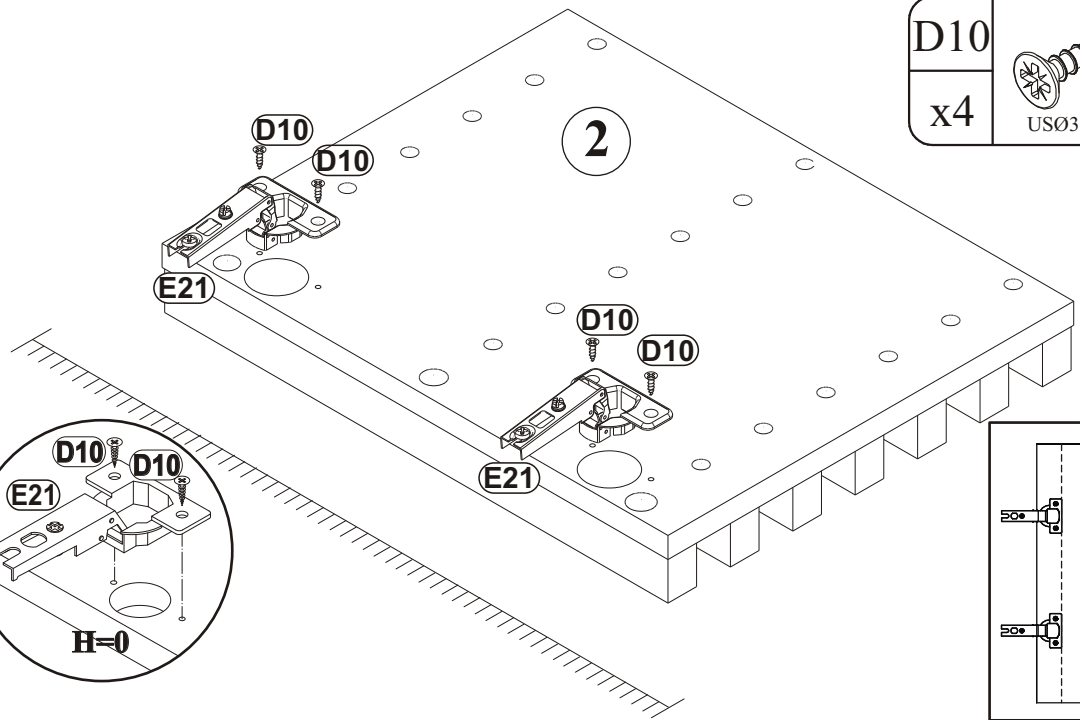

3

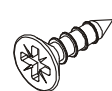
D10	
x6	USØ3,5x13

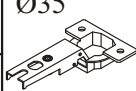
E21	Ø35 
x2	H=0

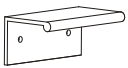
G02	
x1	L-32mm.

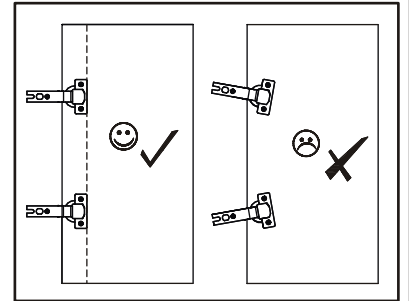
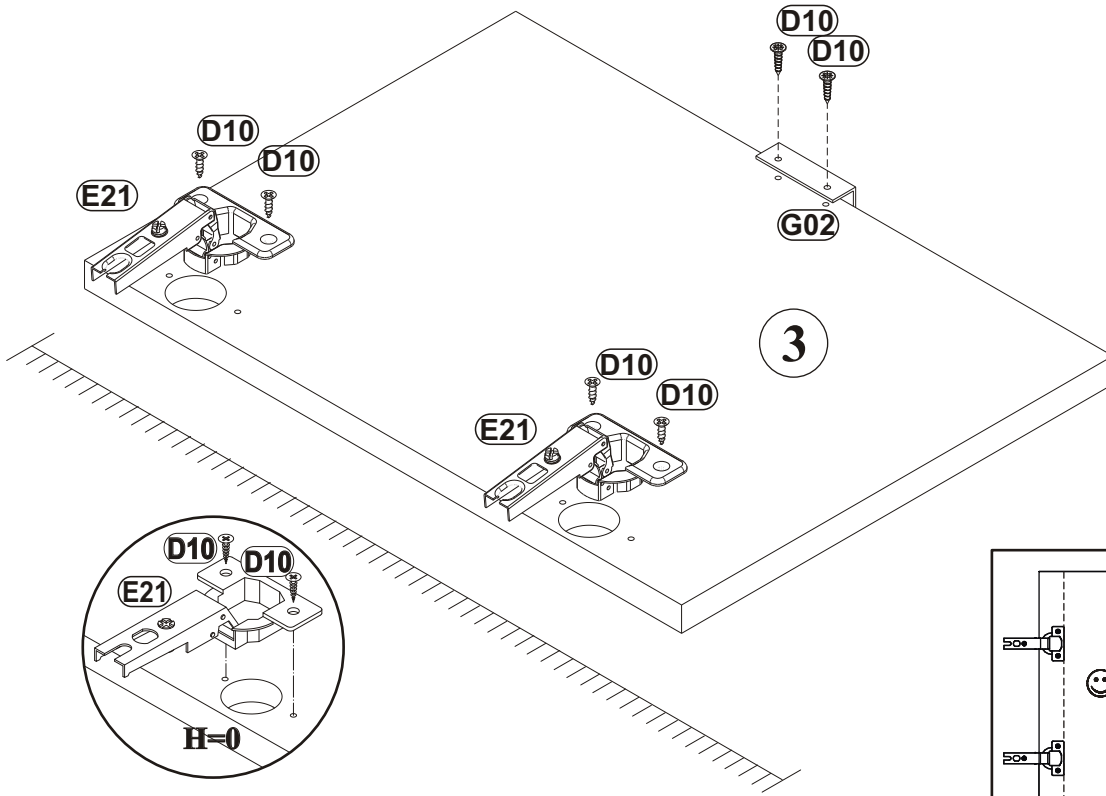

4

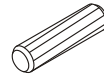
A1	
x4	ø8x36

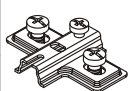
E2	
x2	H=0

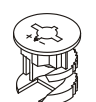
B5	
x4	ø15x12

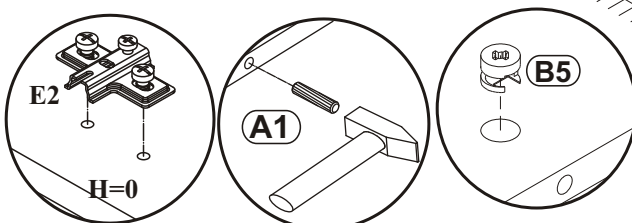
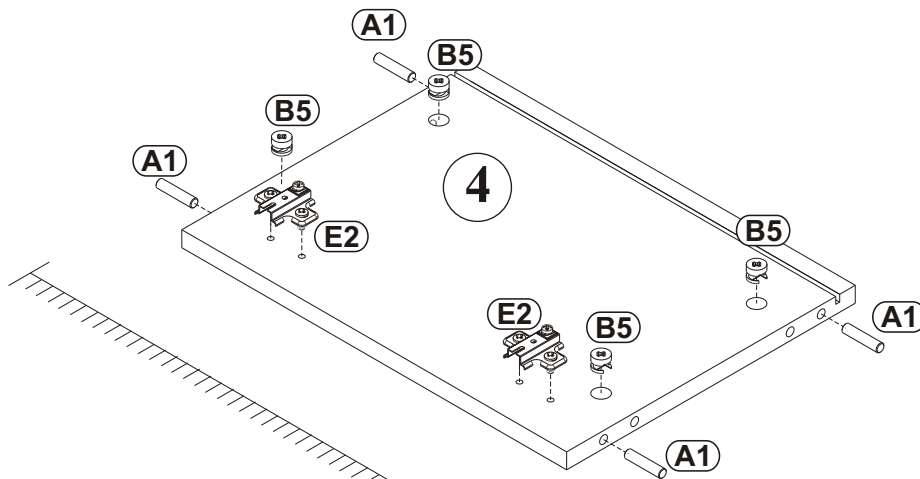

5

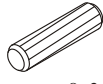
A1	
x4	ø8x36

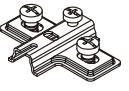
E2	
x2	H=0

B5	
x4	ø15x12

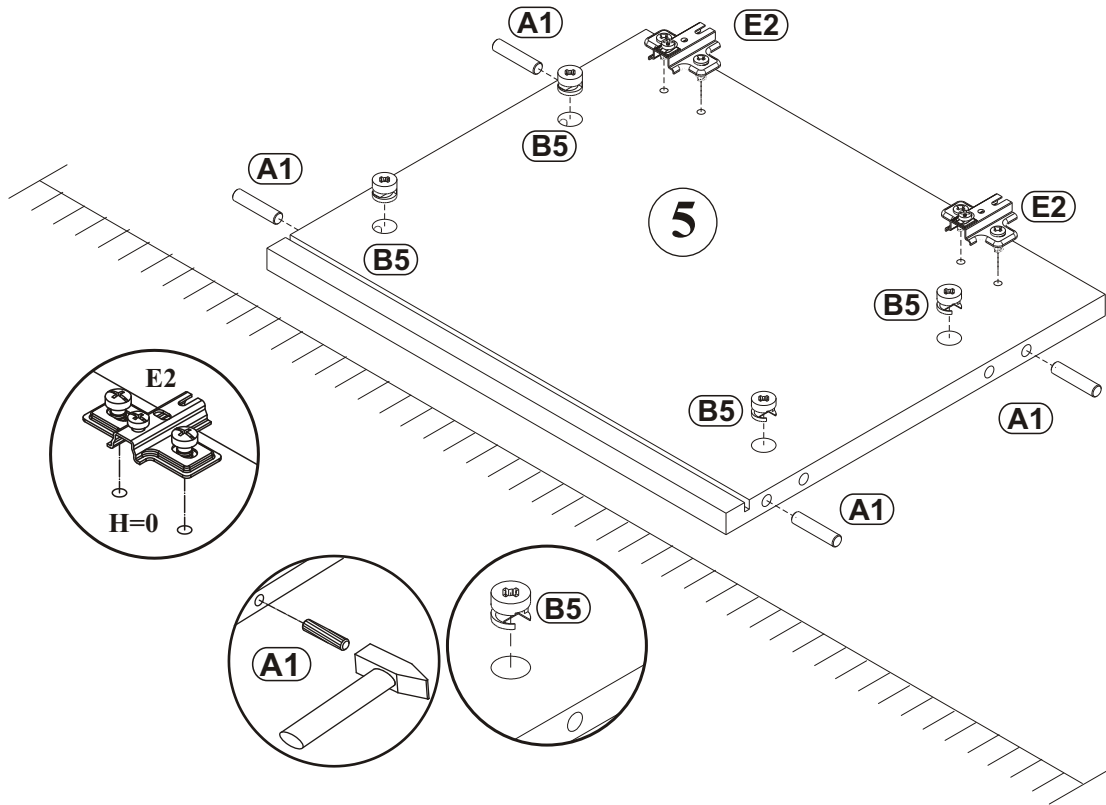

6

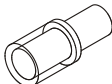
G20	
x2	

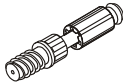
B4	
x4	34

UP17	
x4	UPØ4x25

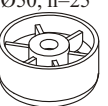
ST7	Ø50, h=25
x4	

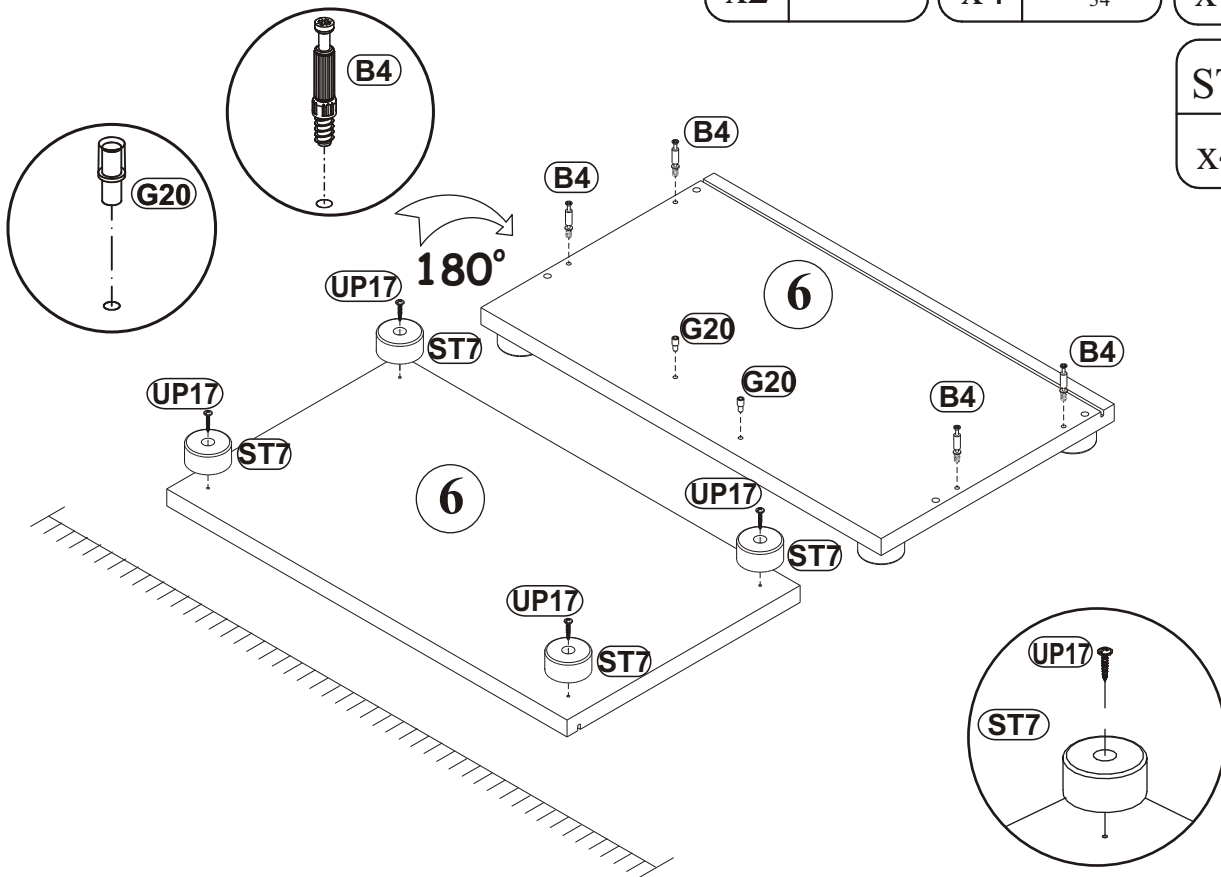

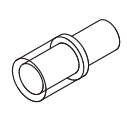
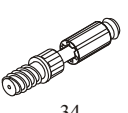
G20		B4	
x2		x4	34

7

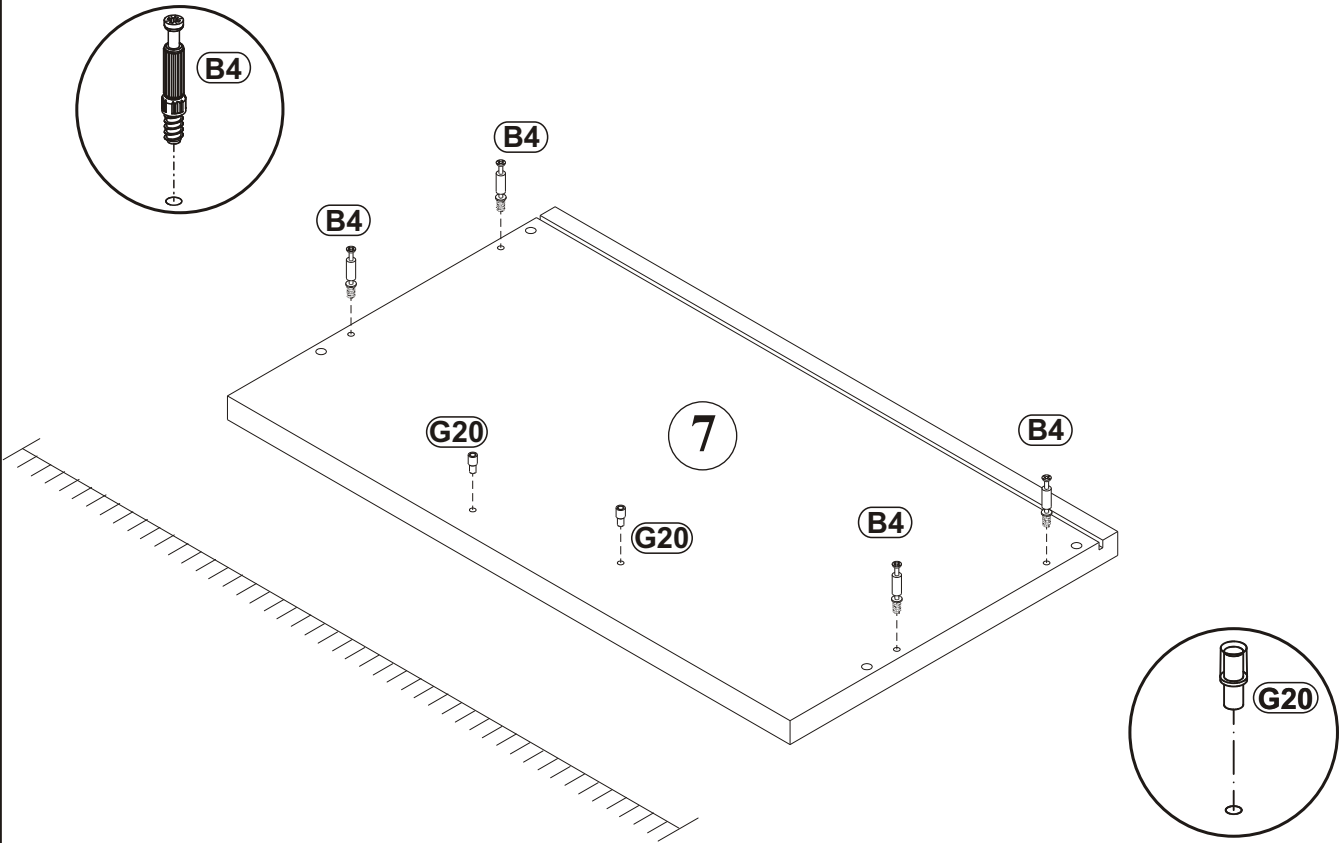

8

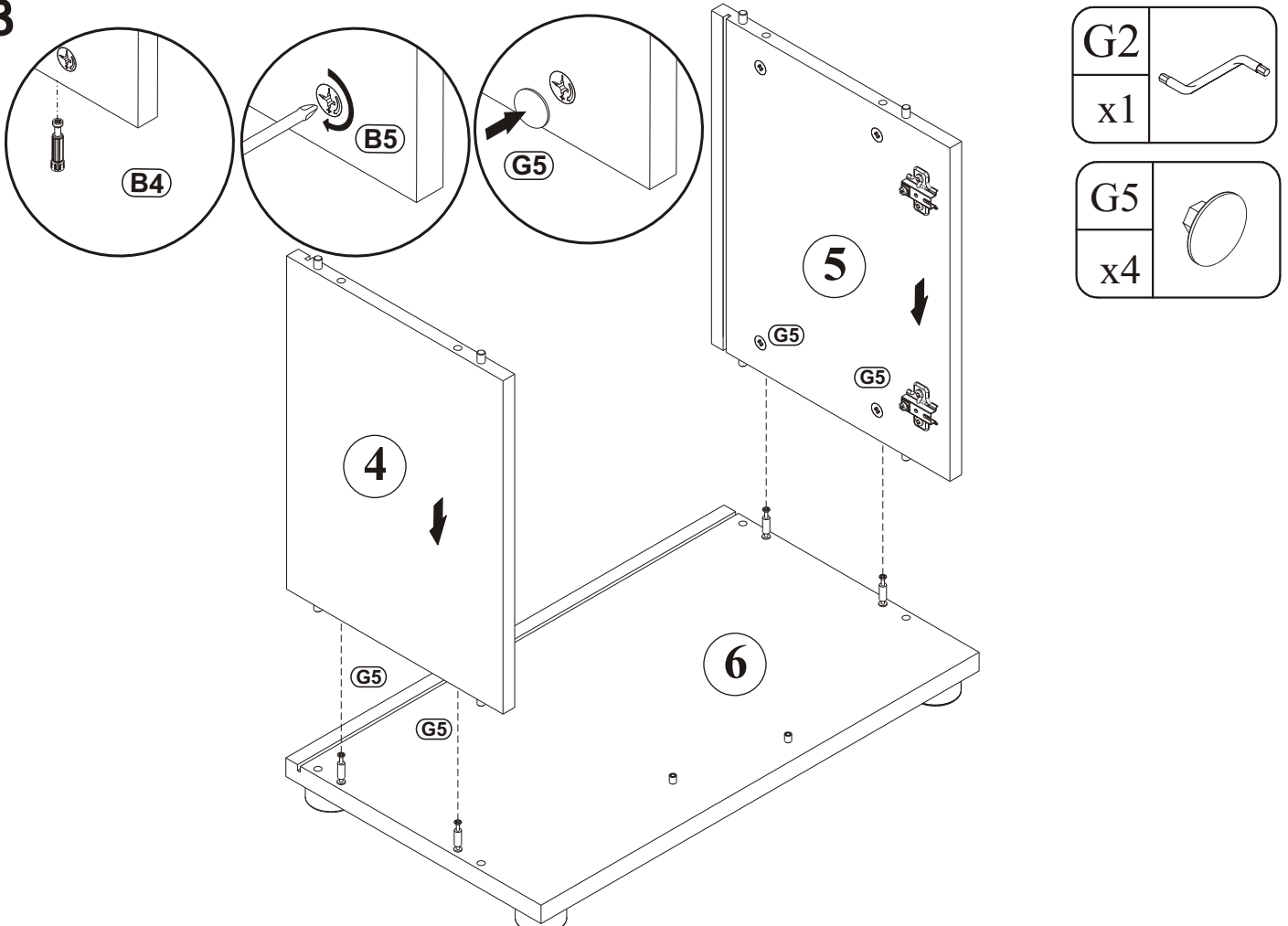



9

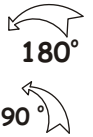
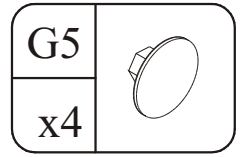
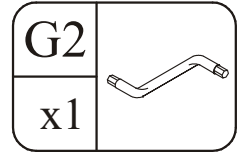
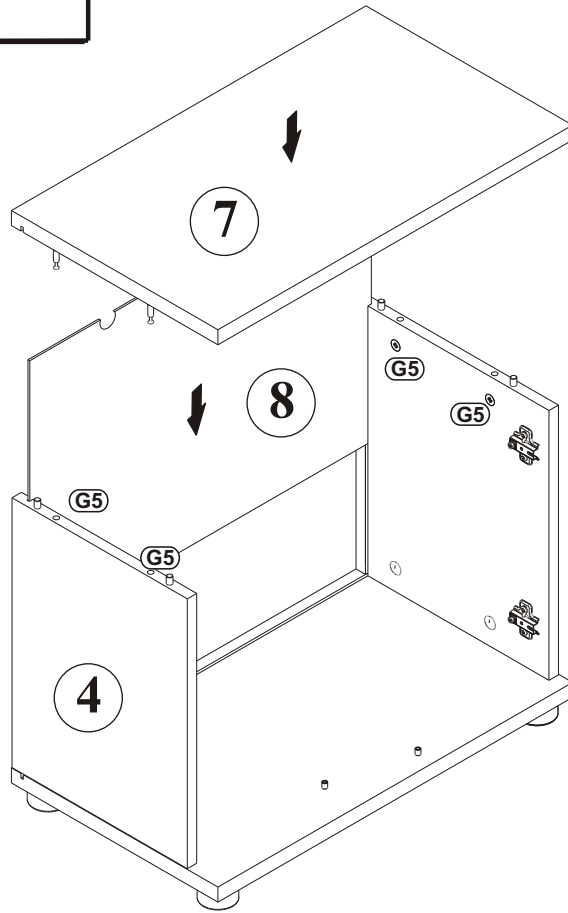
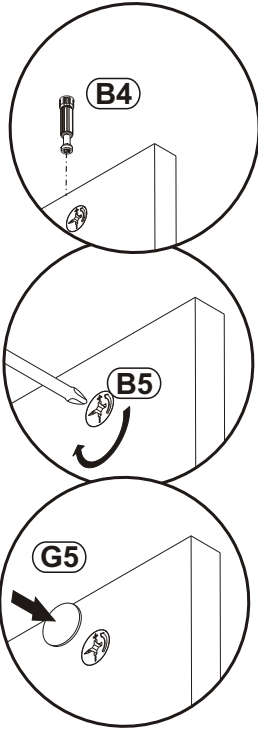

10

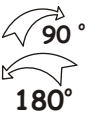
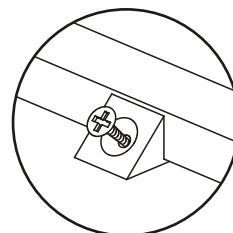
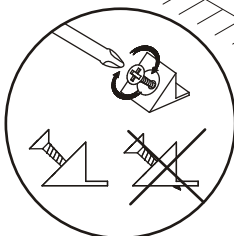
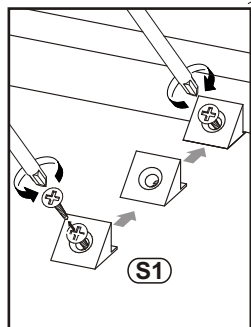
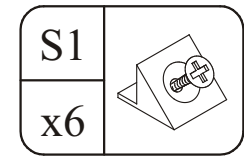
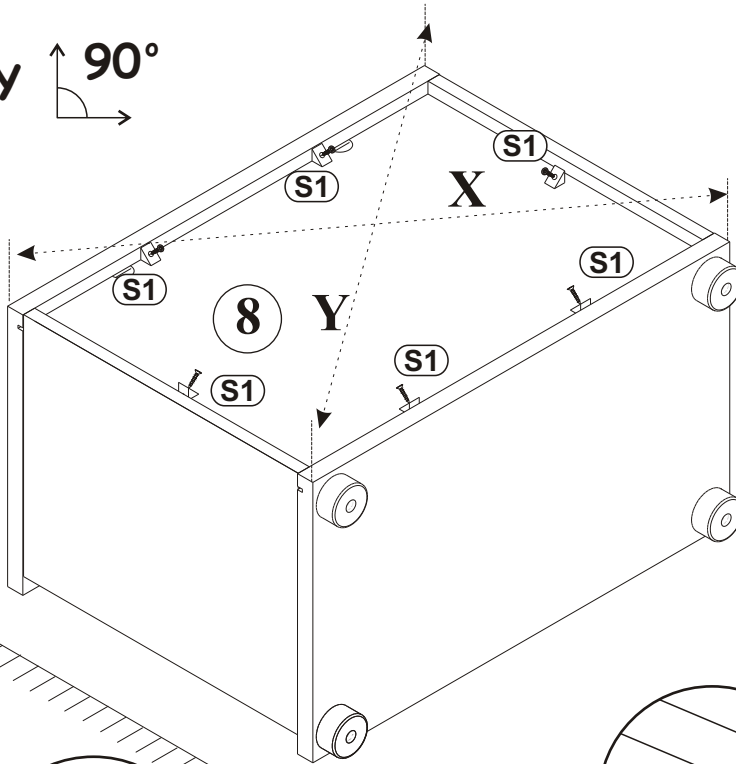

11

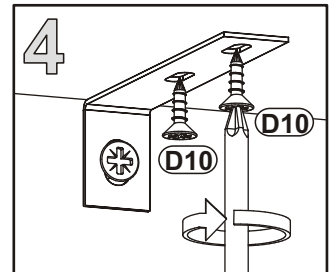
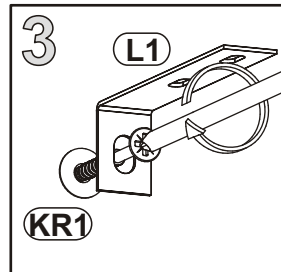
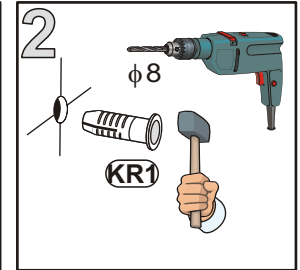
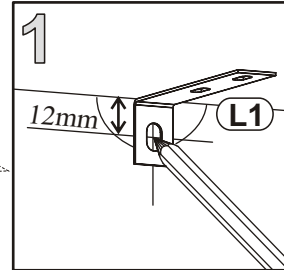
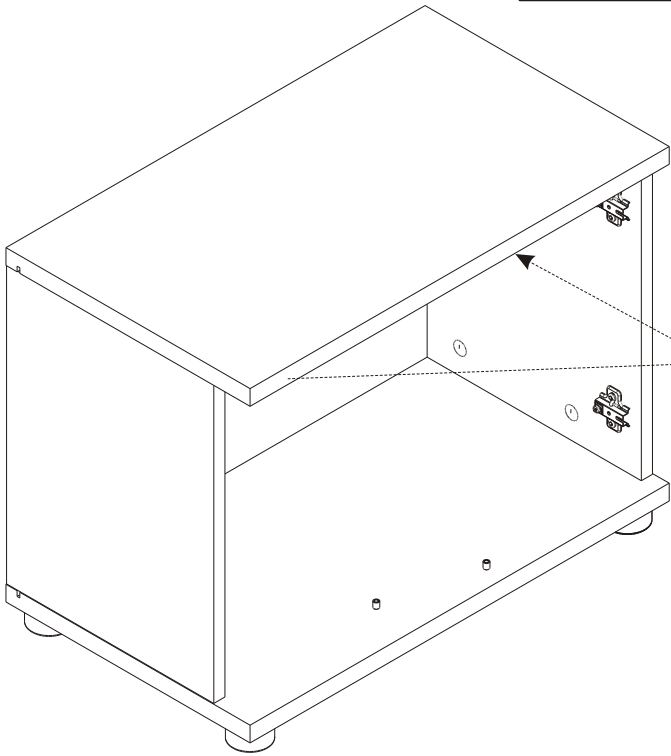
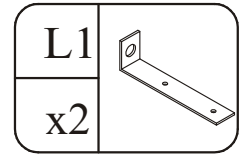
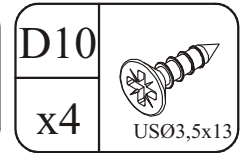
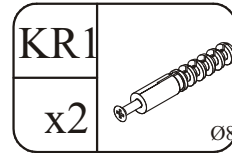
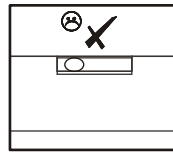
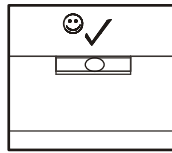

12

