

PEDRO HJZ PD ___ TYP E

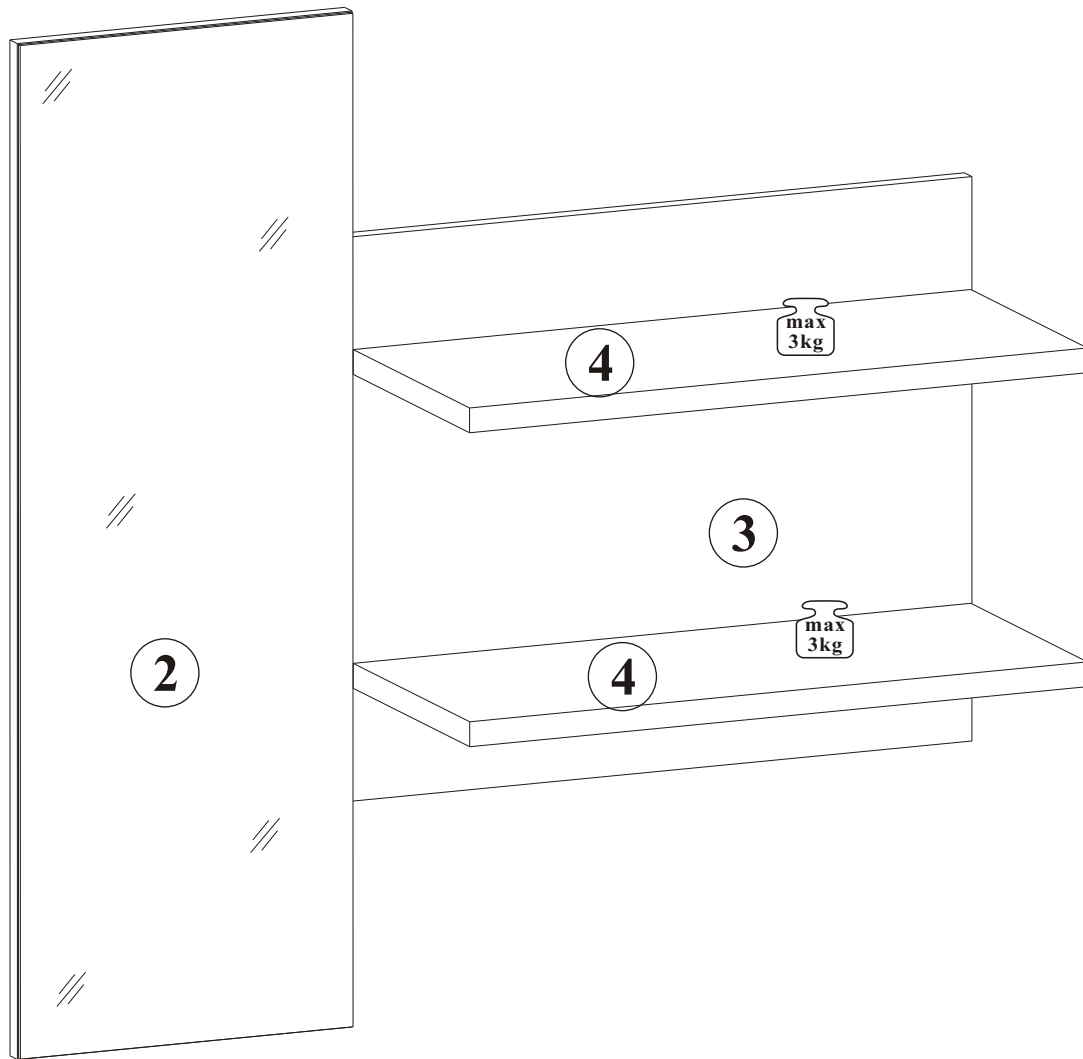

NO	DIM [mm]		COL.-NO	QTY
2	316	900	16 1/1	1
3	585	500	16 1/1	1
4	583	250	22 1/1	2

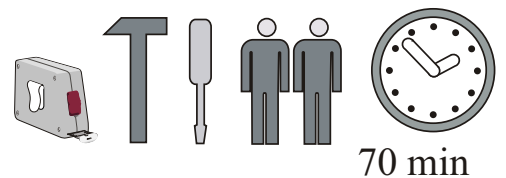



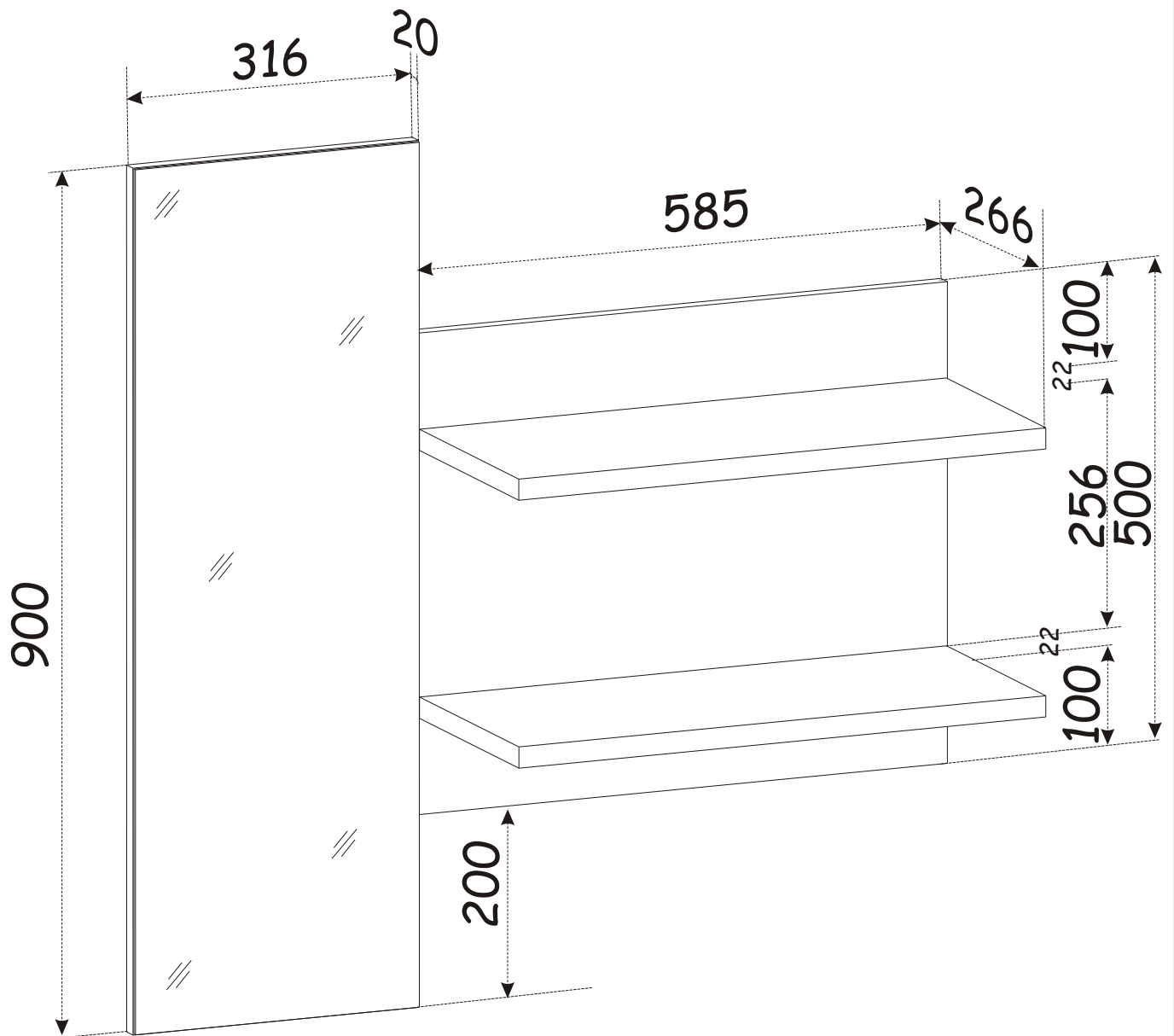

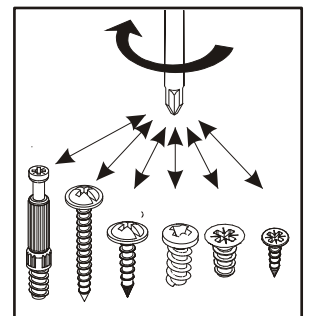
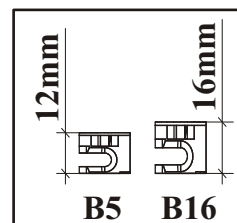
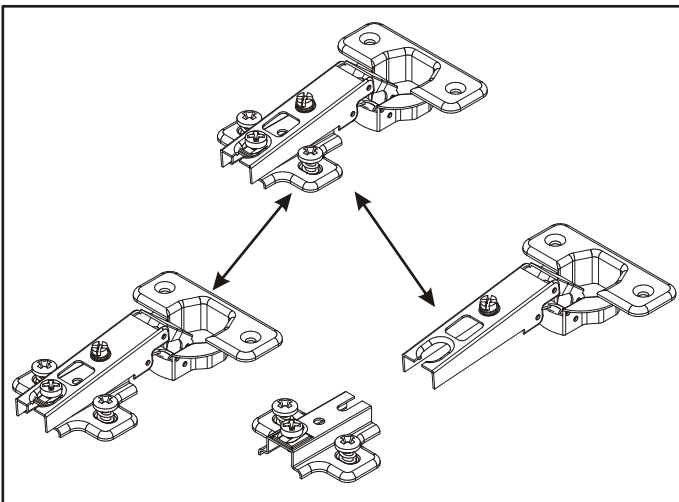
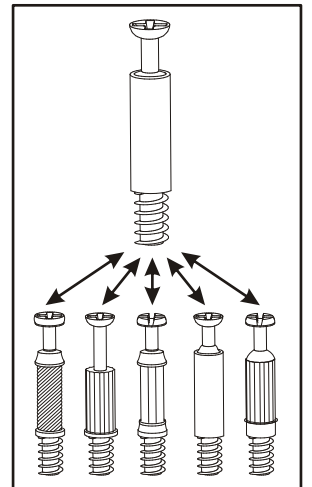
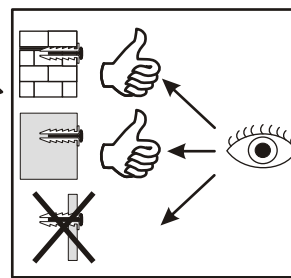
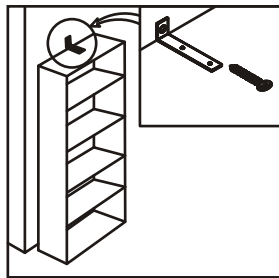
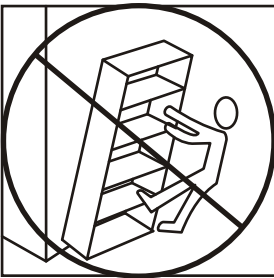
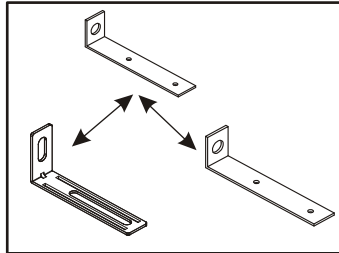
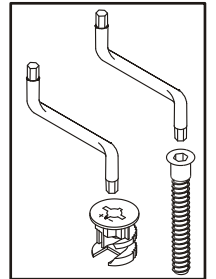
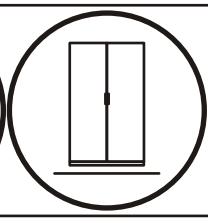
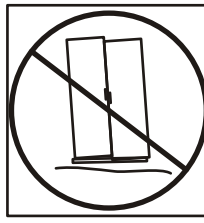
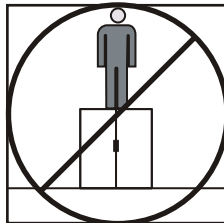
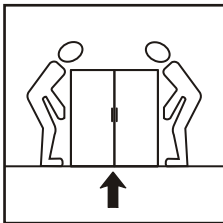
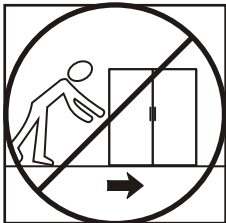
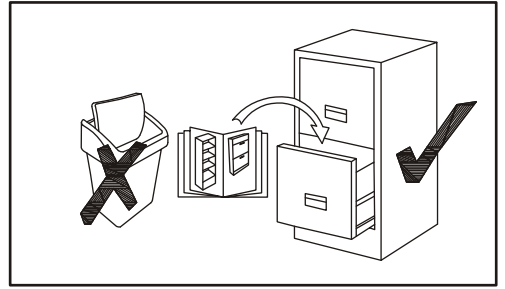
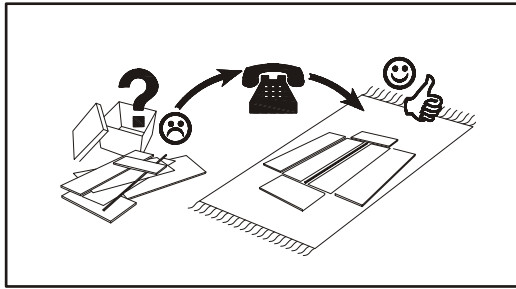
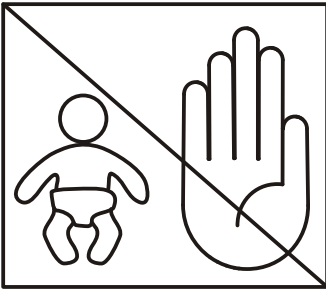
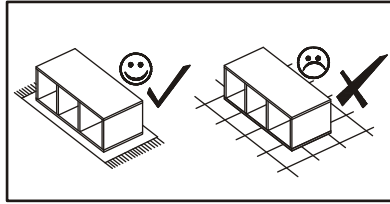
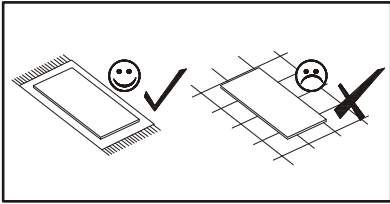
PEDRO HJZ PD _ TYP E



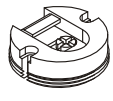
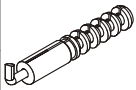

PEDRO HJZ PD _ TYP E

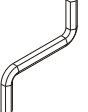
B11		G4		ZM1		KR3		D20		G2	
x10	Ø7x50	x10	C	x3		x6	Ø10	x12	ESØ6,3x9,5	x1	

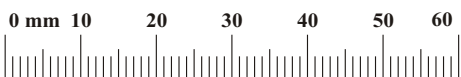

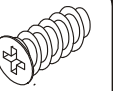
D20	
x6	ESØ6,3x9,5

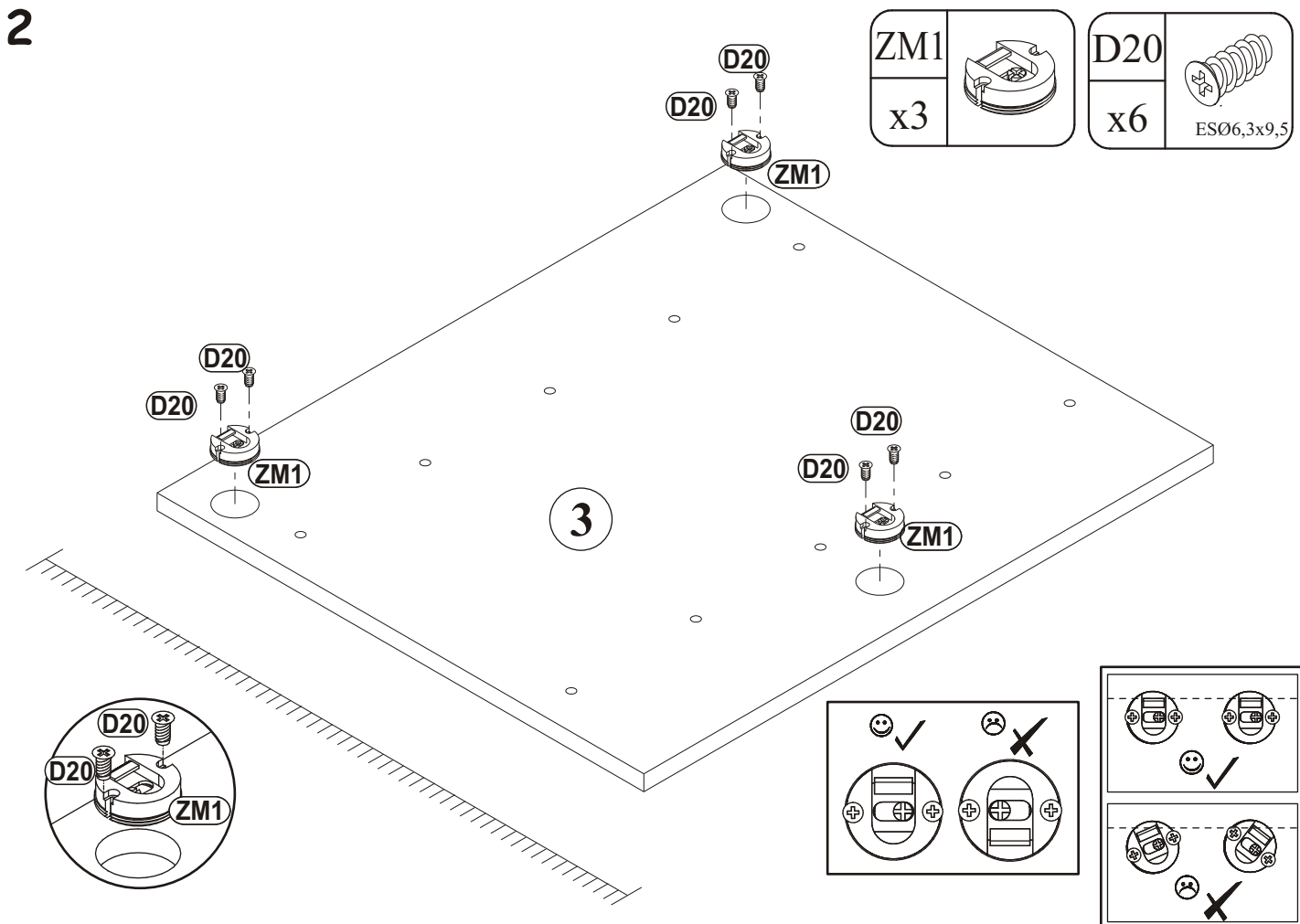
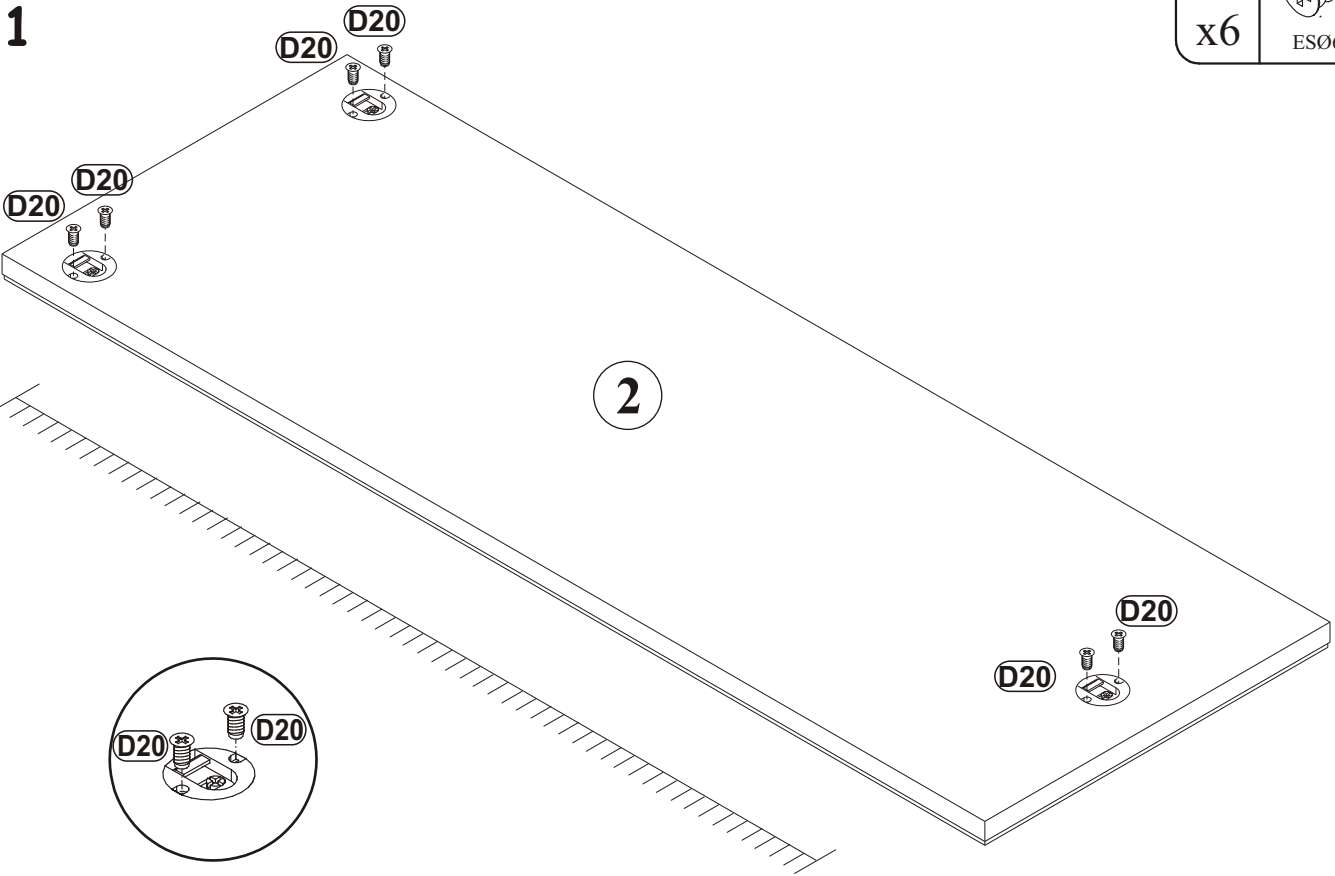

3

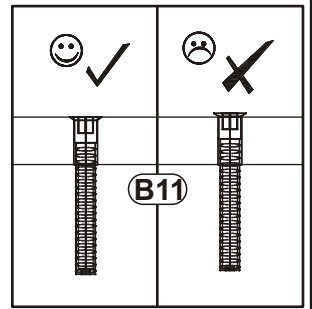
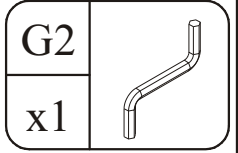
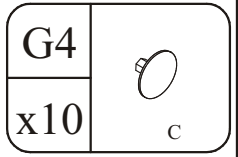
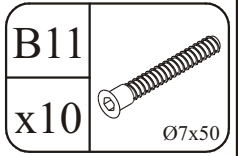
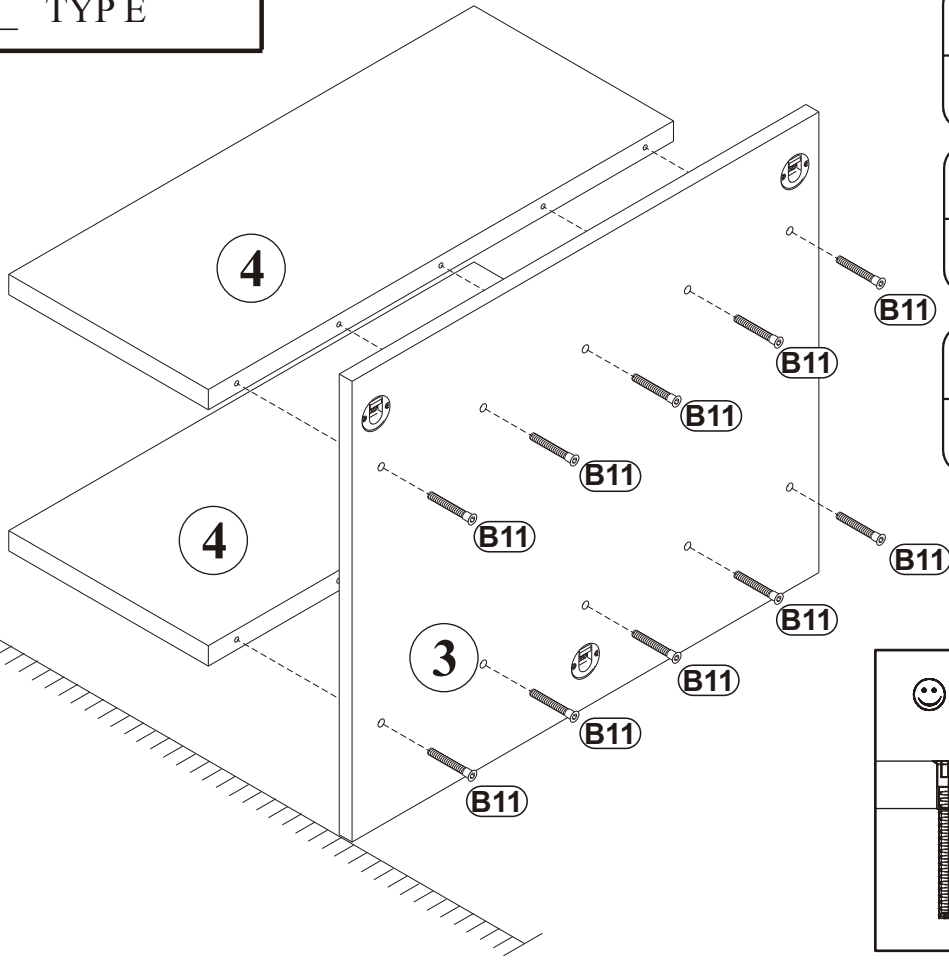
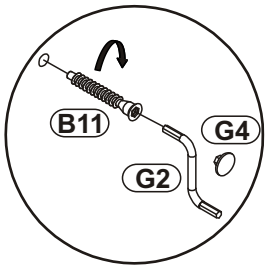

4

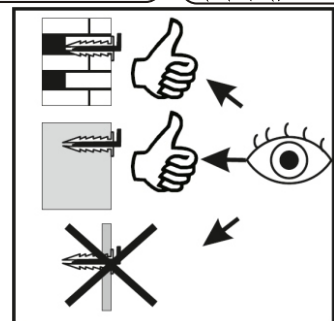
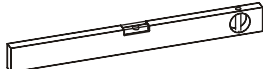
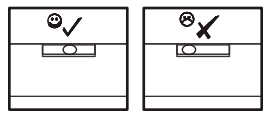
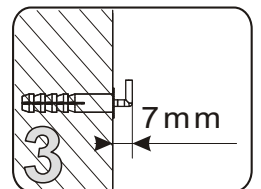
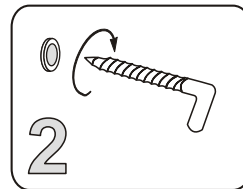
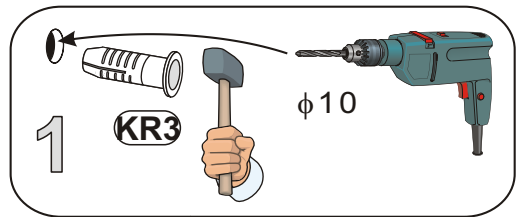
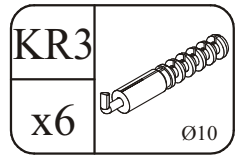
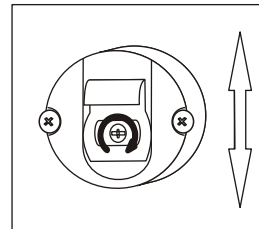
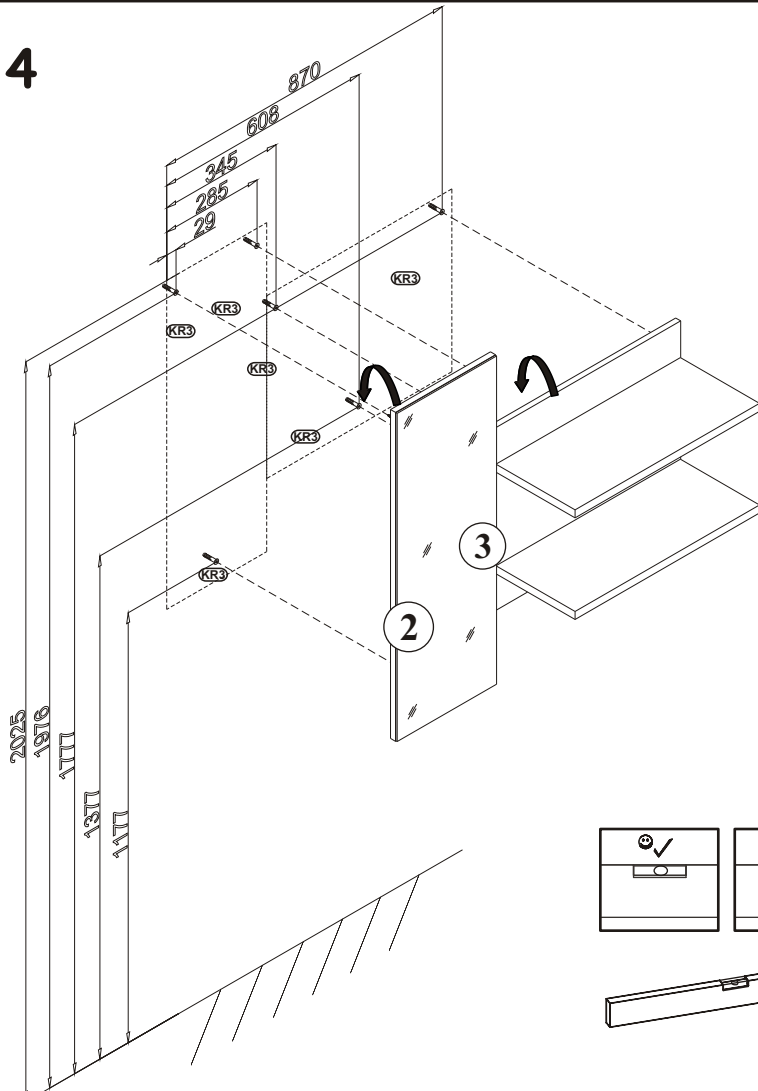

PEDRO HJZ PD __ TYP G

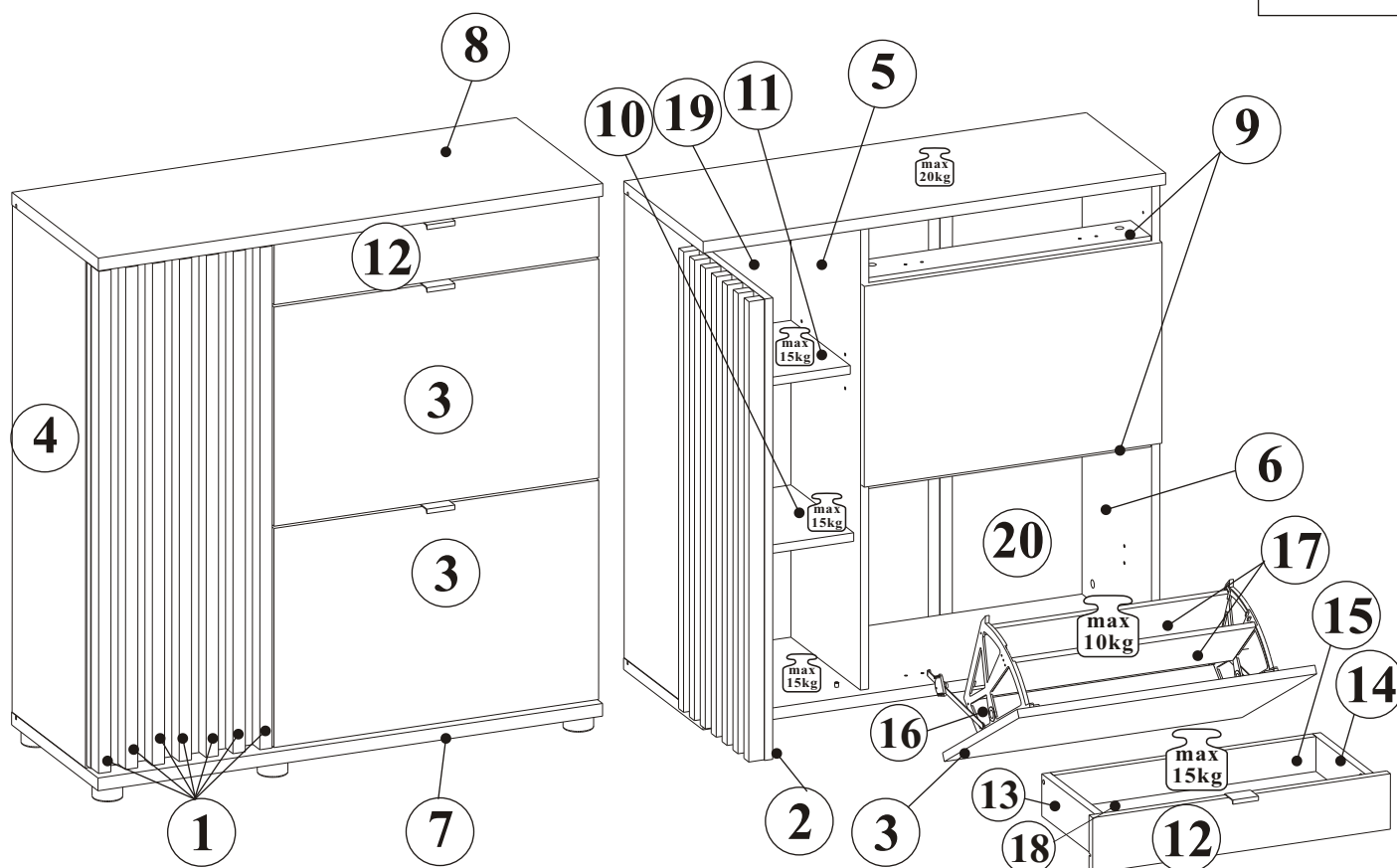
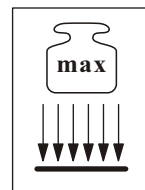

NO	DIM [mm]		COL.-NO	QTY
1	871	30	22 2/2	7
2	312	873	16 2/2	1
3	580	380	16 1/2	2
4	880	297	16 2/2	1
5	880	307	16 2/2	1
6	880	327	16 2/2	1
7	901	350	22 2/2	1
8	901	350	22 2/2	1
9	551	90	16 1/2	2
10	300	277	16 1/2	1
11	300	262	16 1/2	1
12	580	102	16 1/2	1
13	250	80	16 1/2	1
14	250	80	16 1/2	1
15	511	66	16 1/2	1
16	475	80	12 1/2	2
17	475	140	12 1/2	4
18	523	253	3 1/2	1
19	892	314	3 2/2	1
20	892	564	3 2/2	1

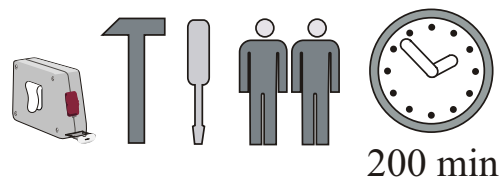



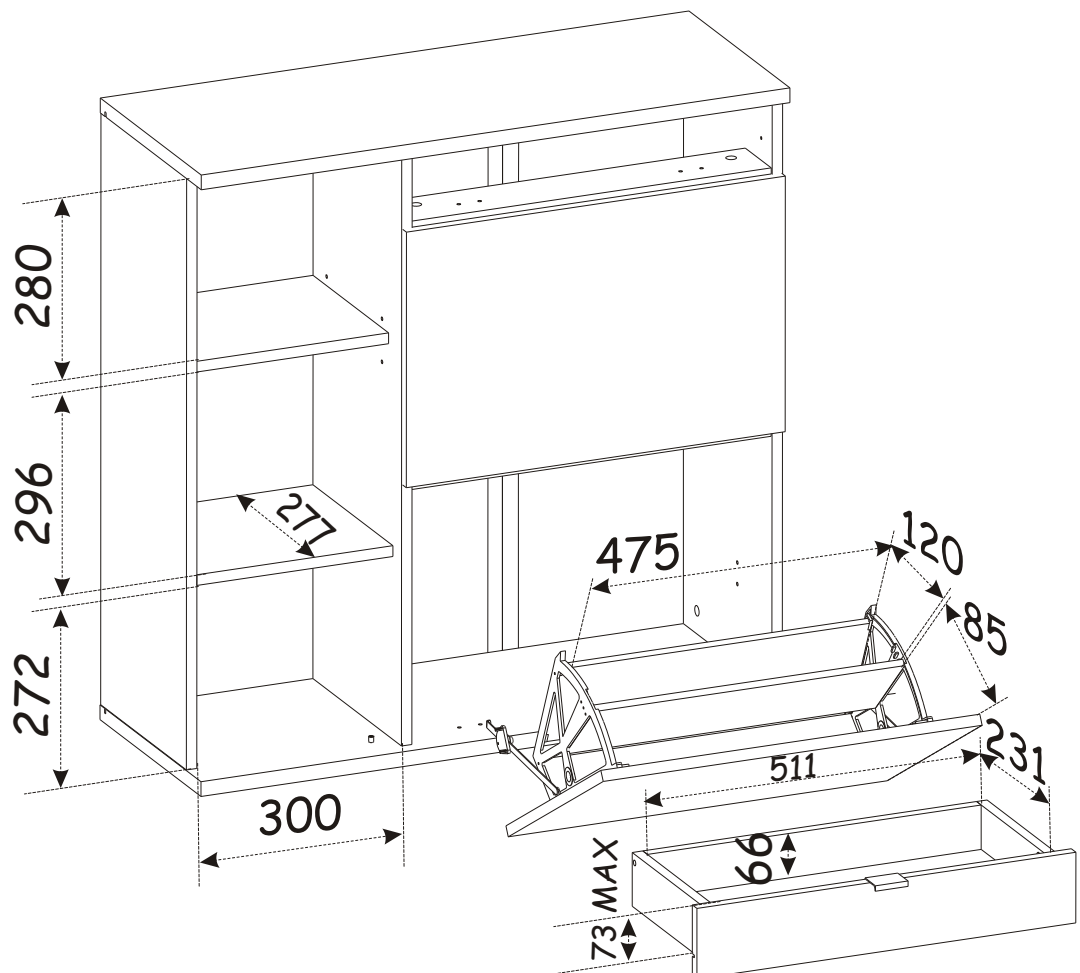
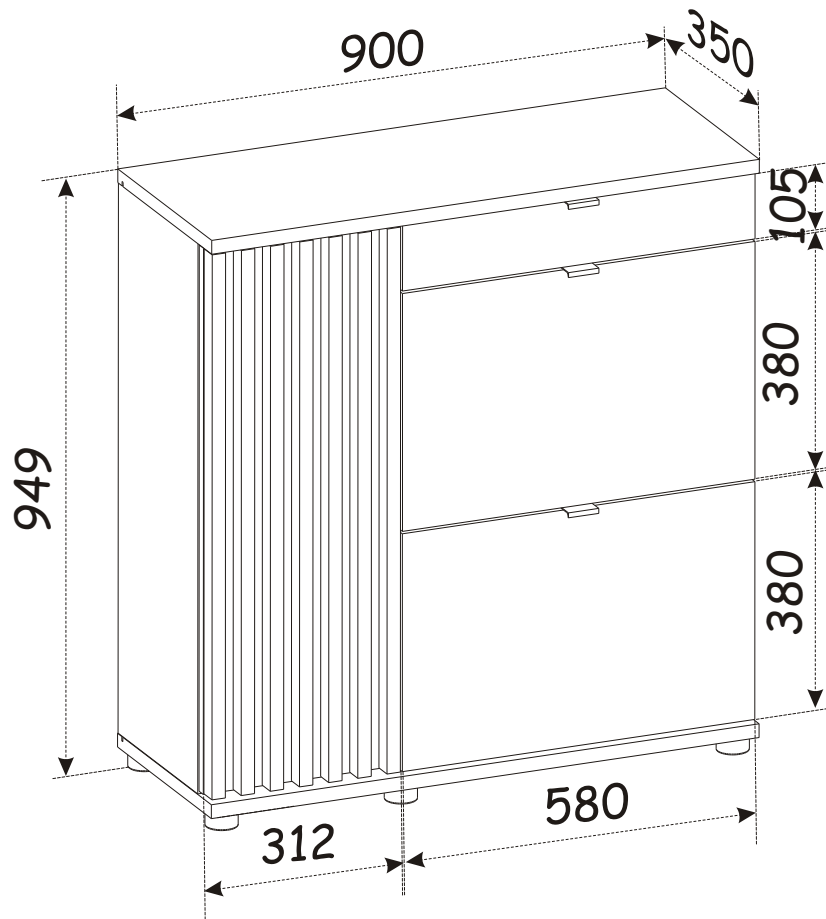

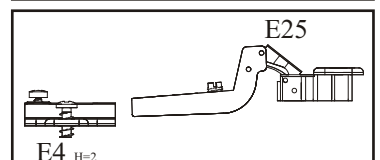
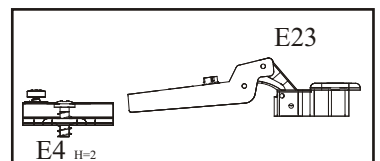
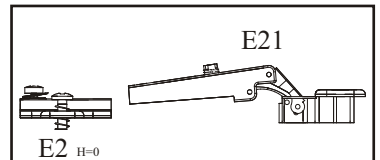
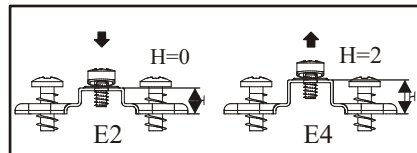
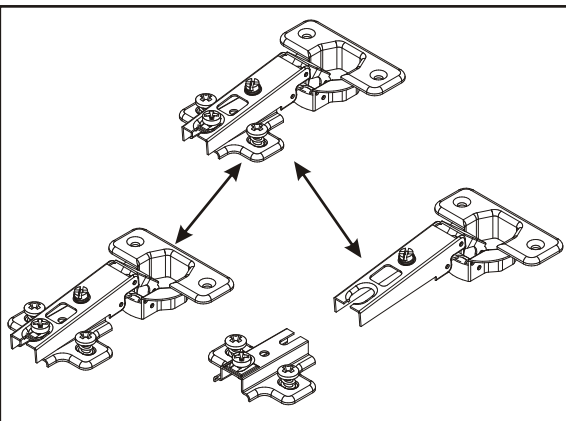
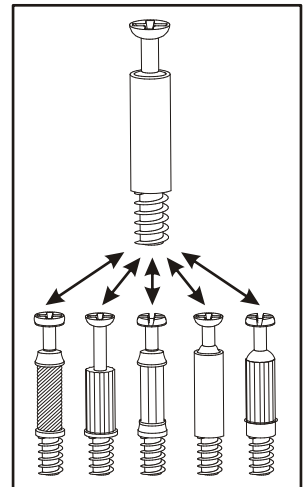
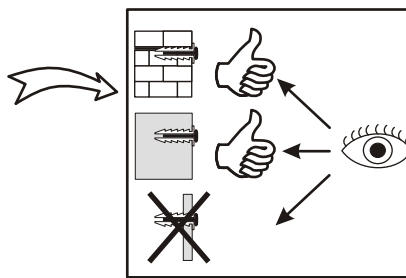
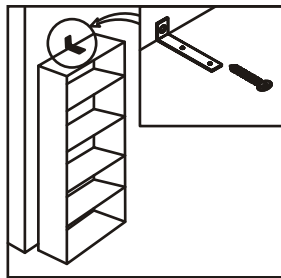
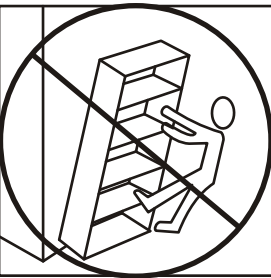
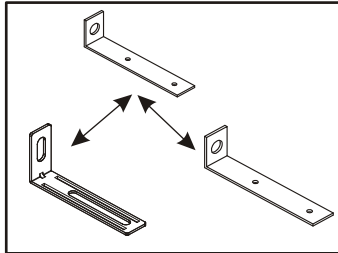
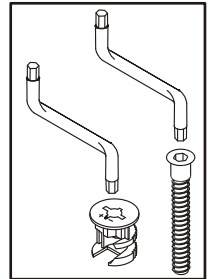
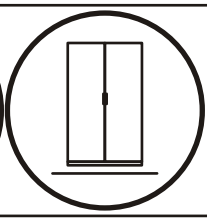
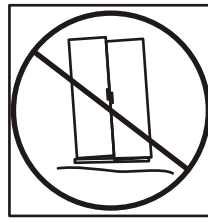
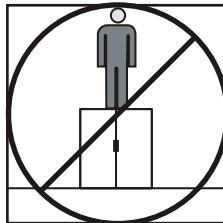
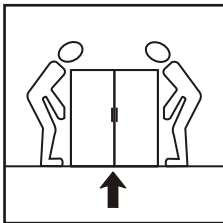
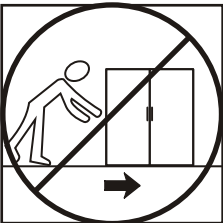
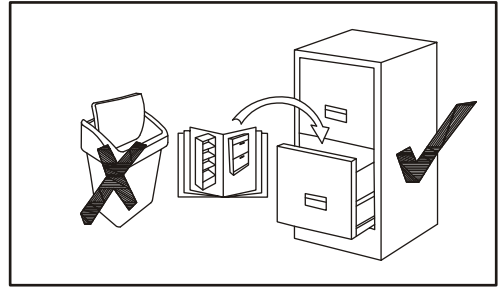
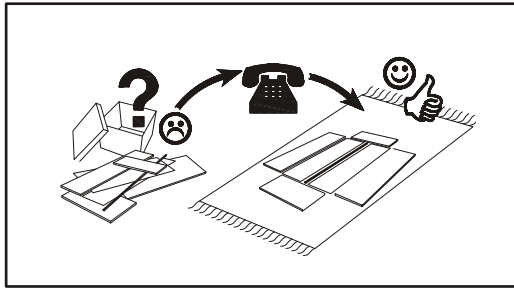
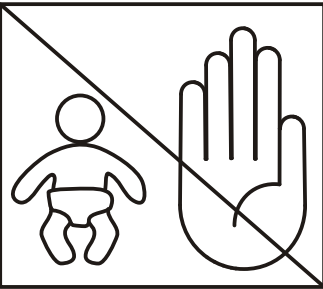
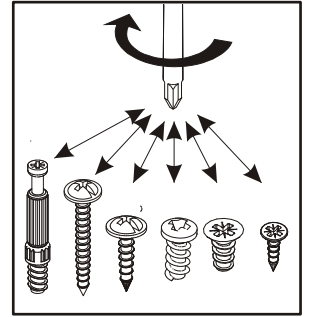
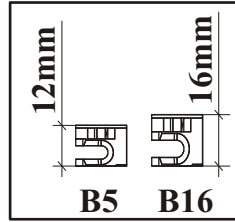
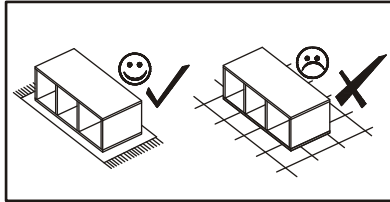
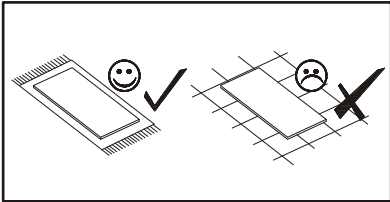



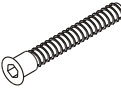

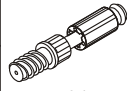



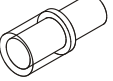
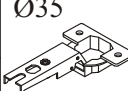
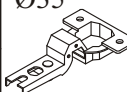
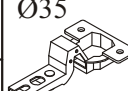
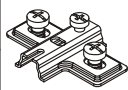
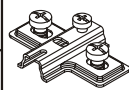
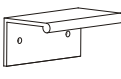

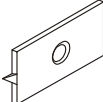
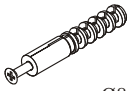
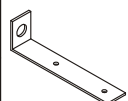
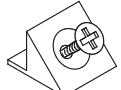
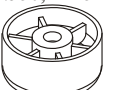
PEDRO HJZ PD _ TYP G

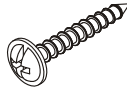
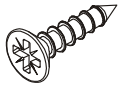

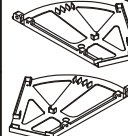

PEDRO HJZ PD __ TYP G

A1 x24 ø8x36		B11 x2 ø7x50		B22 x21 ø7x40		G4 x20		B4 x22 34		B5 x22 ø15x12	
G5 x22		G7 x4		G20 x2		E21 x2 ø35 H=0		E23 x2 ø35 H=8		E25 x2 ø35 H=16	
E2 x2 H=0		E4 x4 H=2		G02 x3 L-32mm.		G21 x4		G16 x6		KR1 x2 ø8	
L1 x2		S1 x14		ST7 x6 ø50, h=25		QU1 x1 L-250mm		UP17 x6 UPø4x25		D7 x12 USø3x16	
D10 x34 USø3,5x13		UP9 x38 UPø3,5x16		D20 x4 ESø6,3x9,5		BU2 x2		G2 x1		G12 x3 ø14	

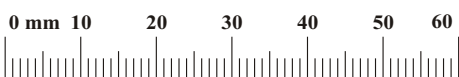

PEDRO HJZ PD __ TYP G

G12		B22		G4	
x3	Ø14	x21	Ø7x40	x18	

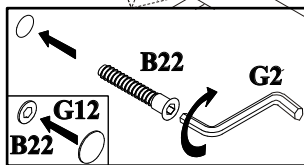
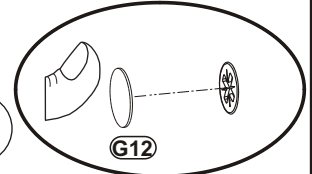
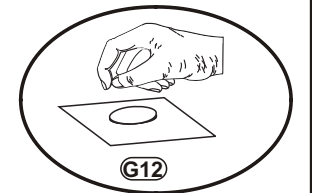
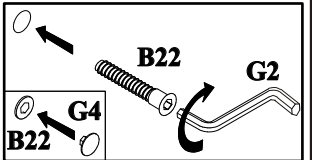
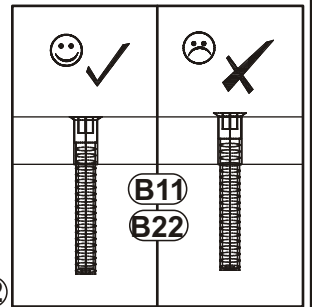
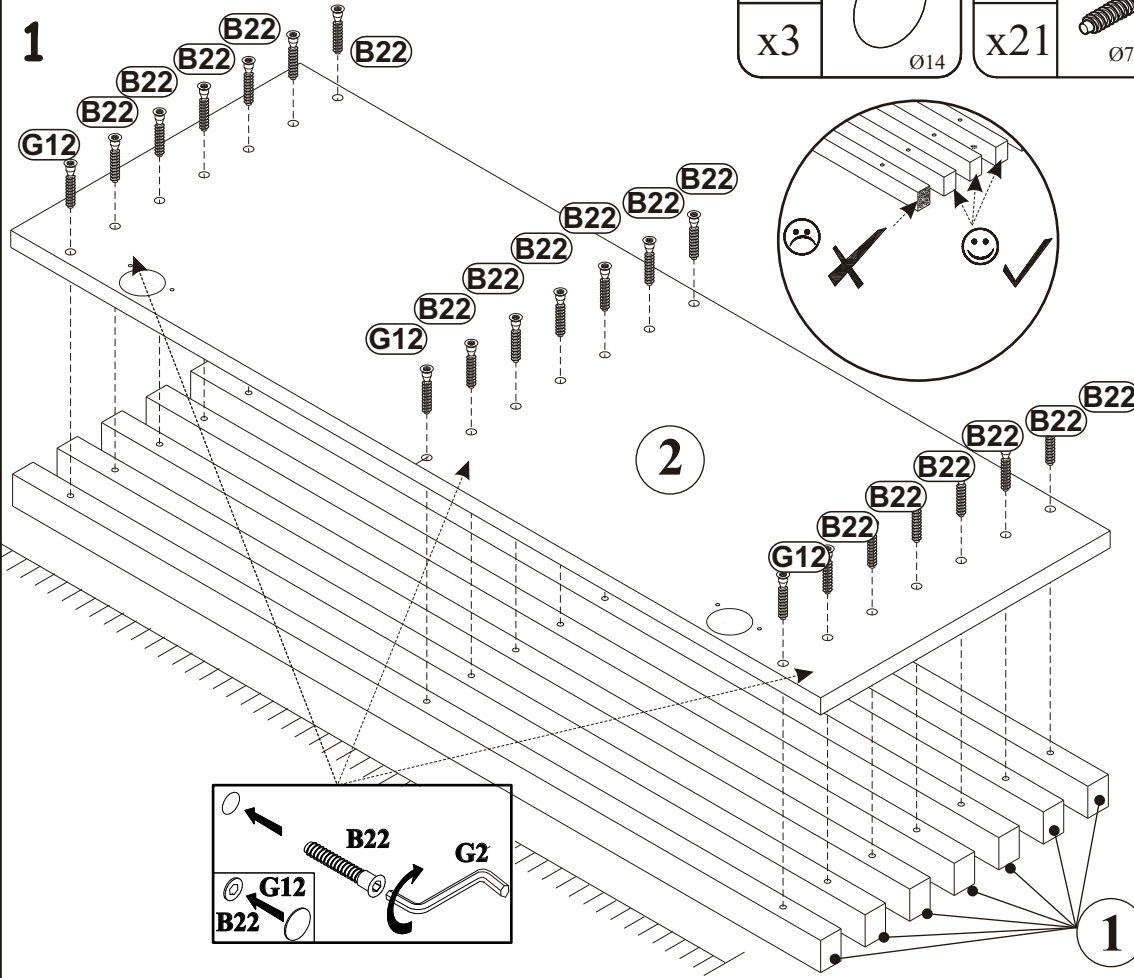

2

D10		E21	
x4	USØ3,5x13	x2	Ø35 H=0

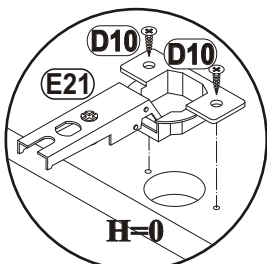
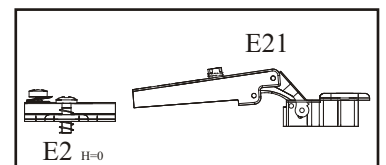
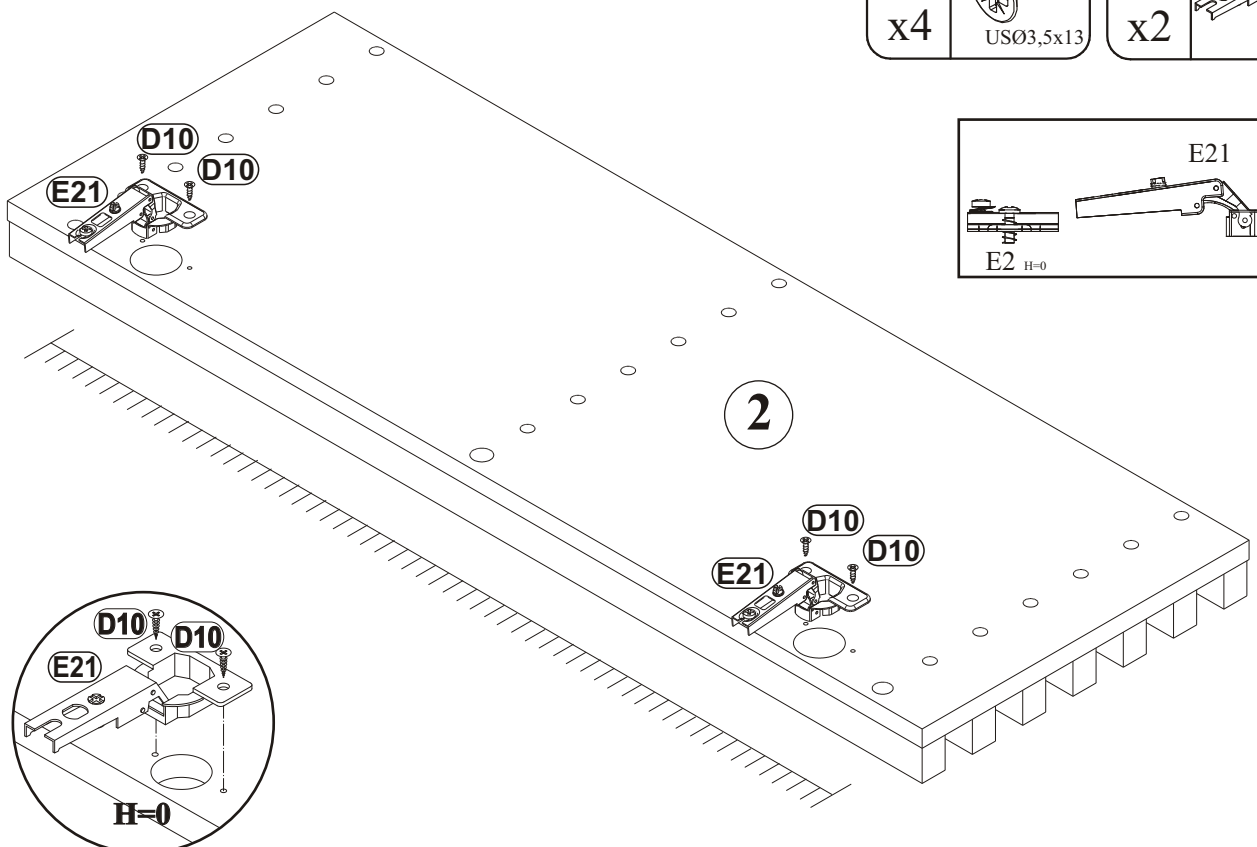

3

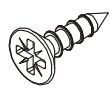
D10	
x8	USØ3,5x13

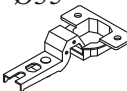
E23	Ø35	
x2	H=8	

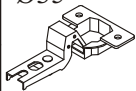
E25	Ø35	
x2	H=16	

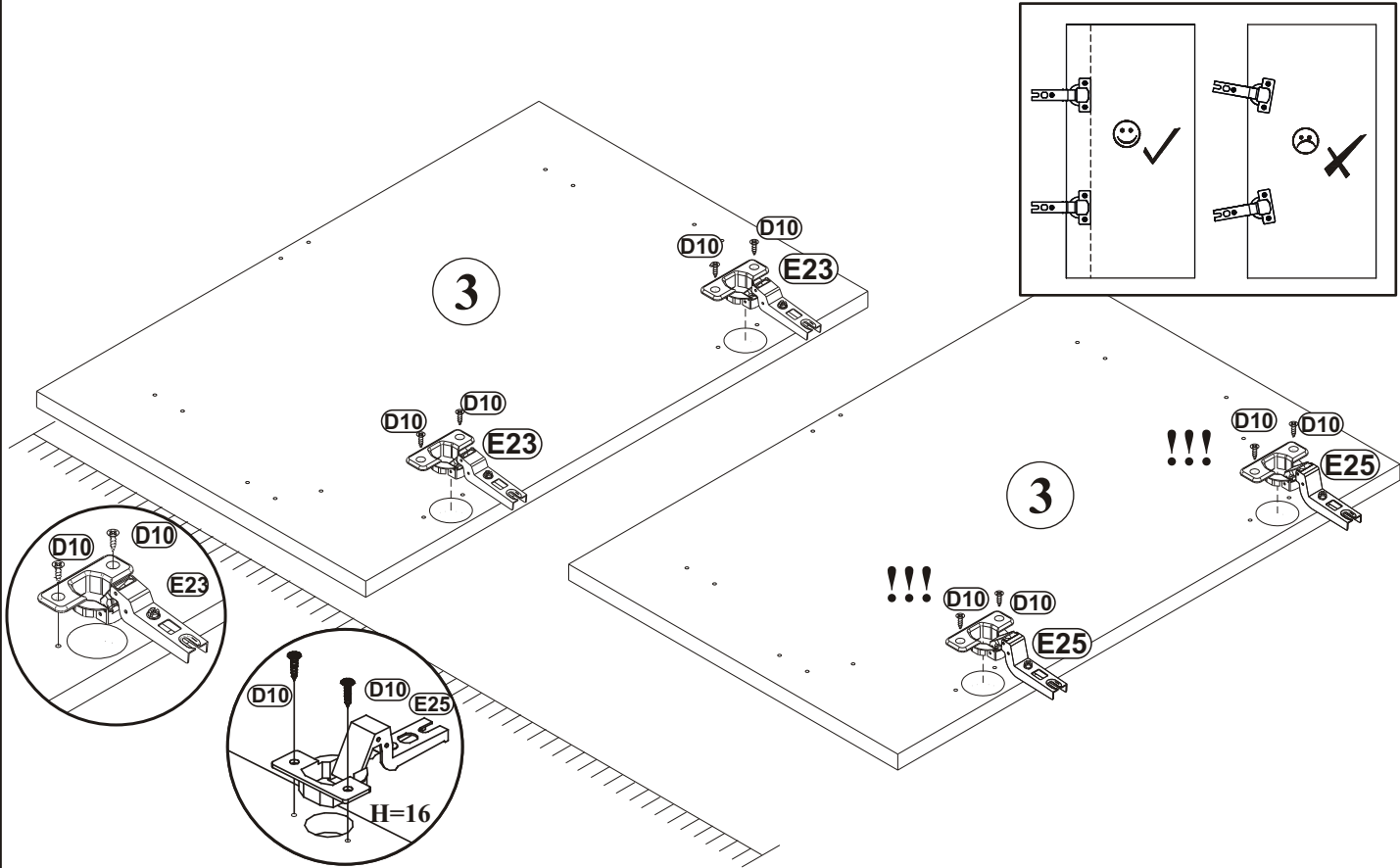

4

UP9	
x12	UPØ3,5x16

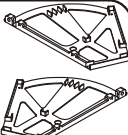
BU2	
x2	

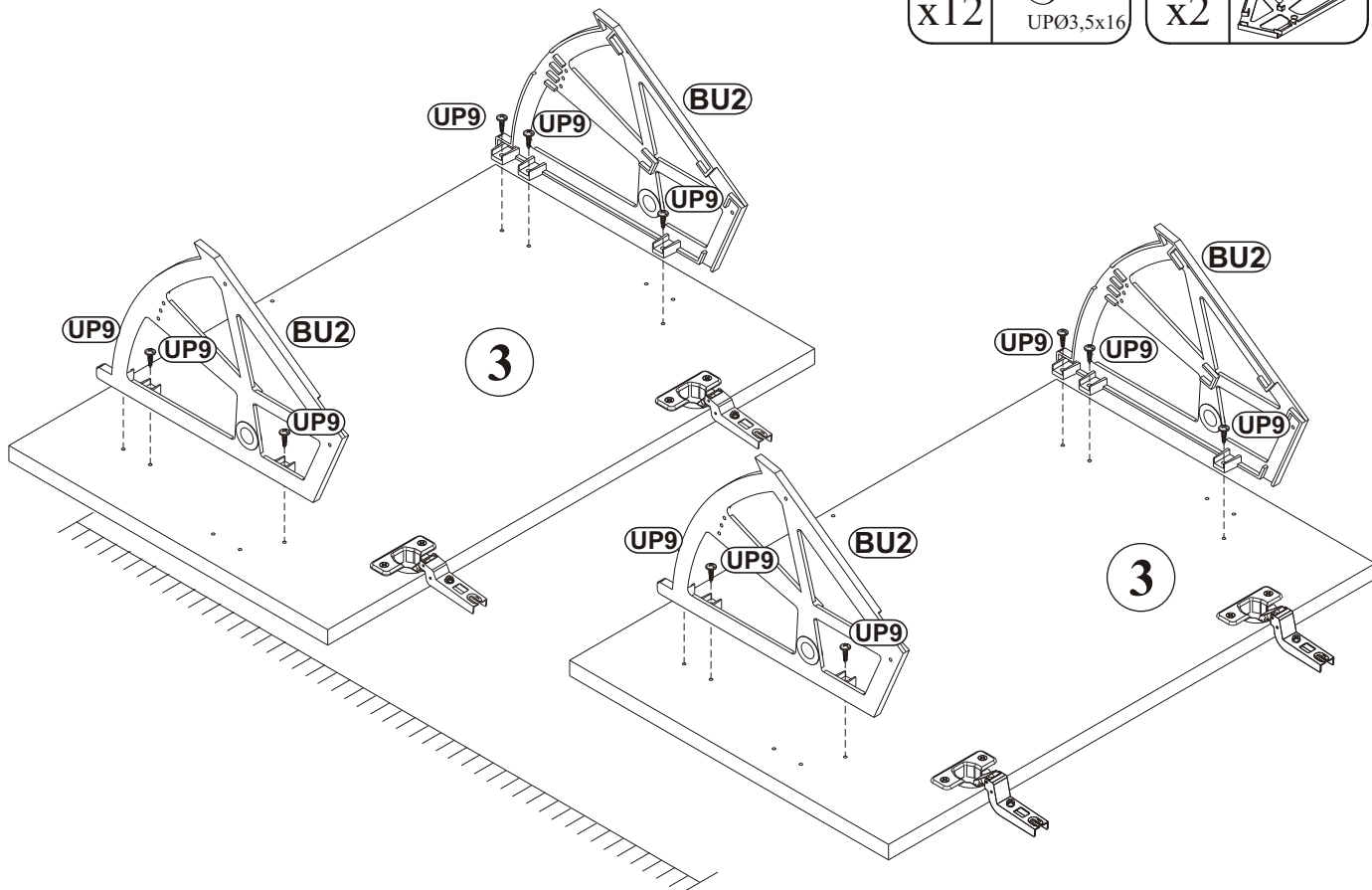

5

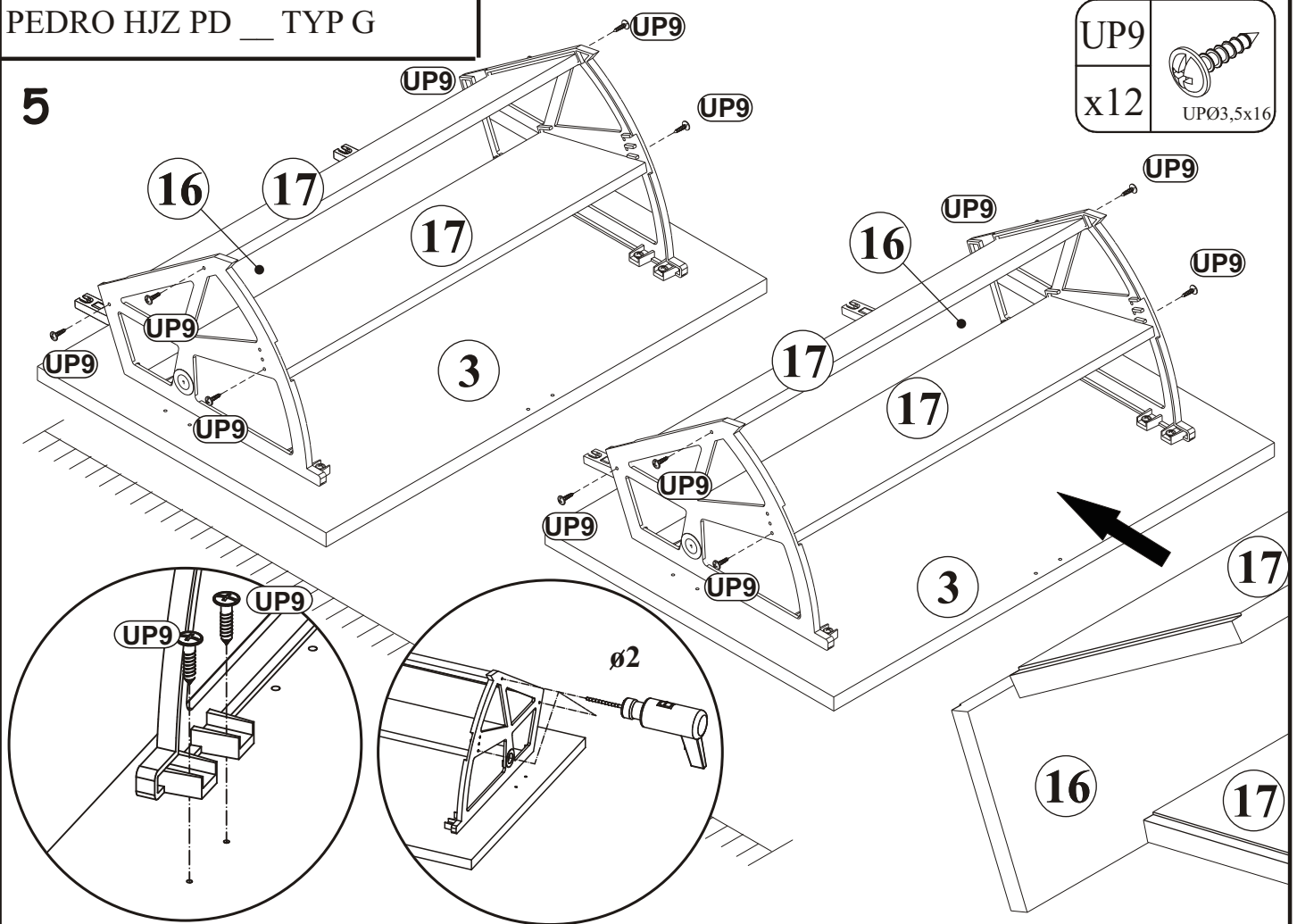

UP9	
x12	UP $\varnothing 3,5 \times 16$

6

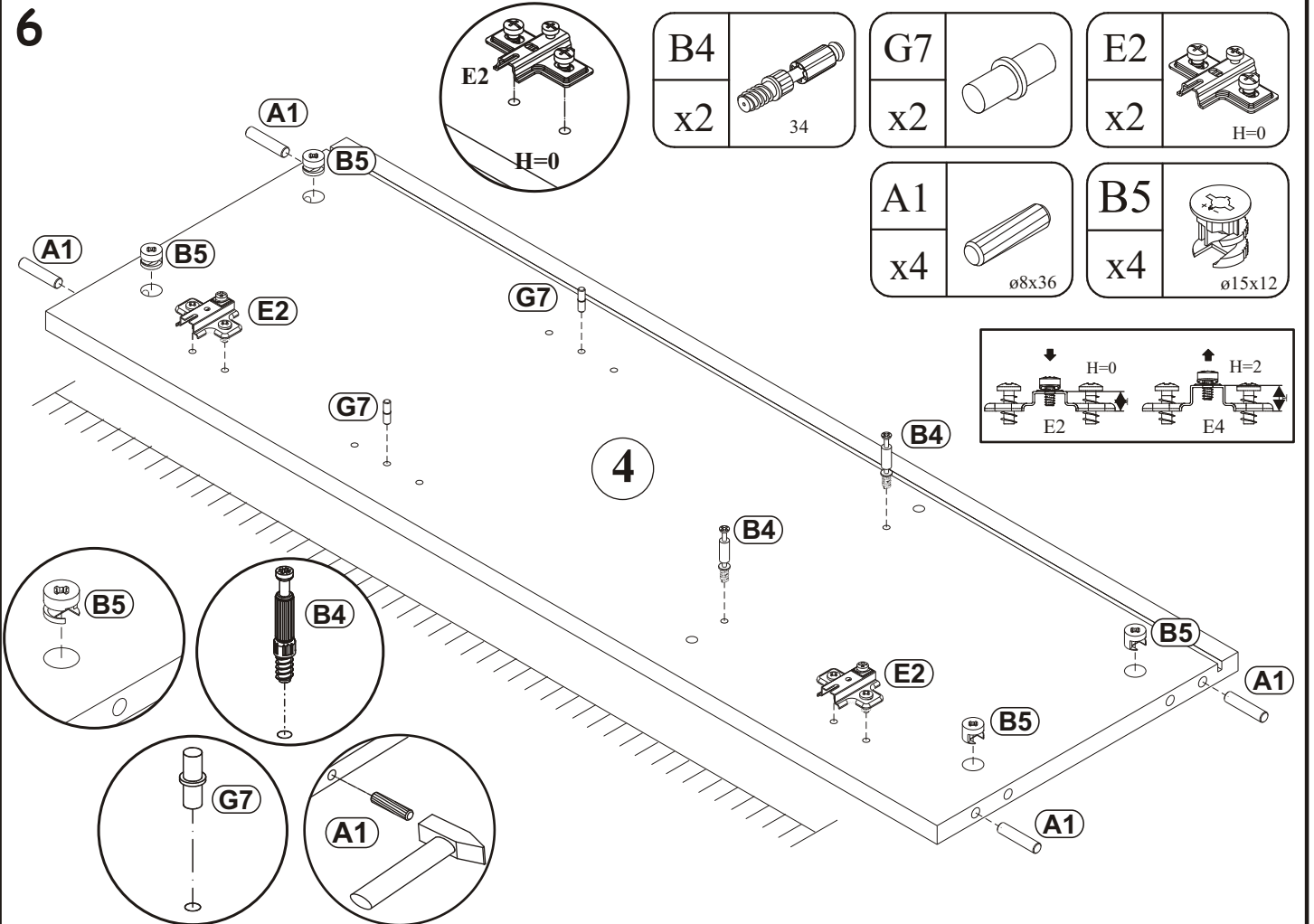

PEDRO HJZ PD __ TYP G

B4 x4	 34	B5 x4	 ø15x12	A1 x4	 ø8x36
G7 x2	 	D20 x2	 ESØ6,3x9,5	QU1 x1	 L-250mm
				D10 x2	 USØ3,5x13

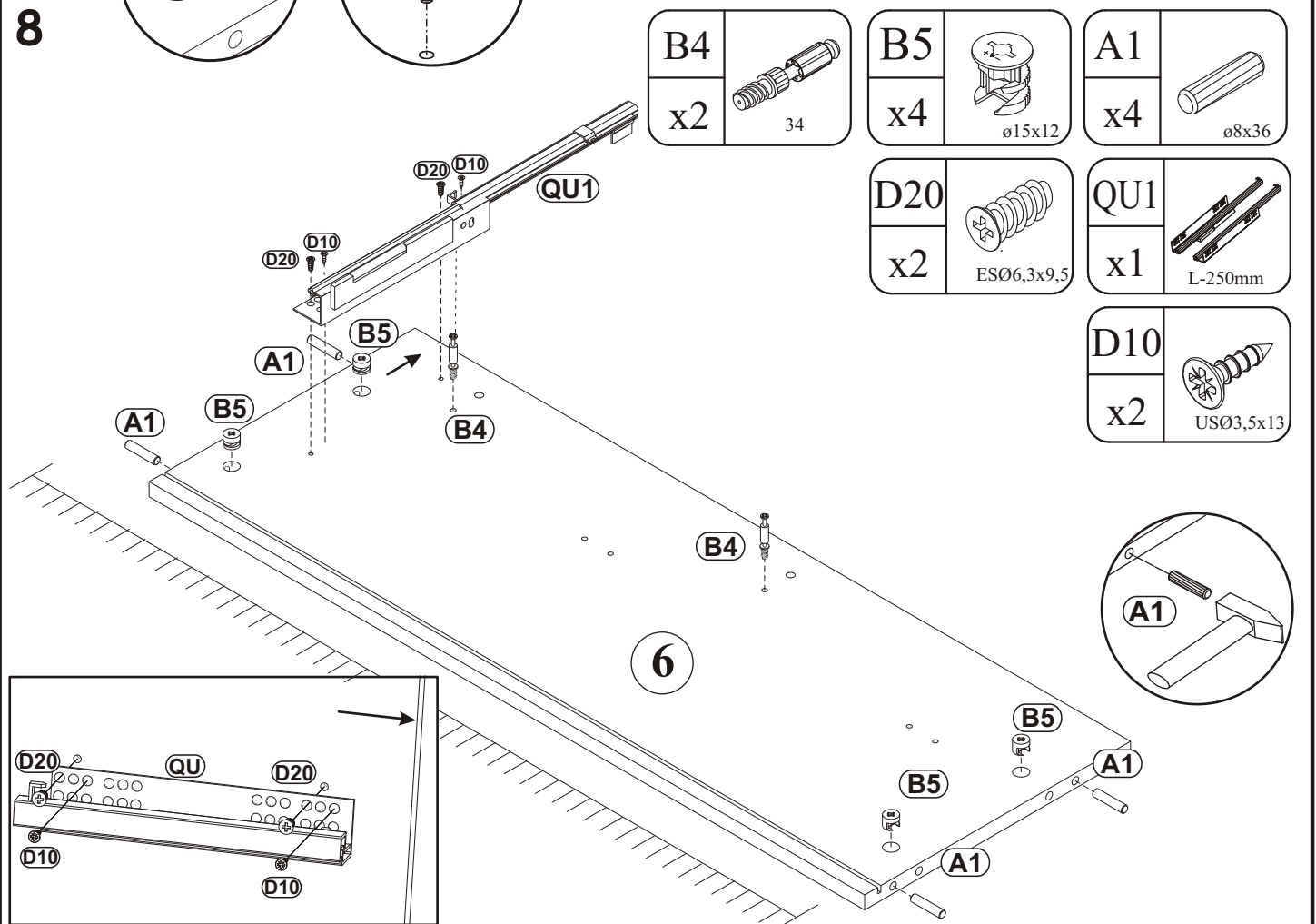
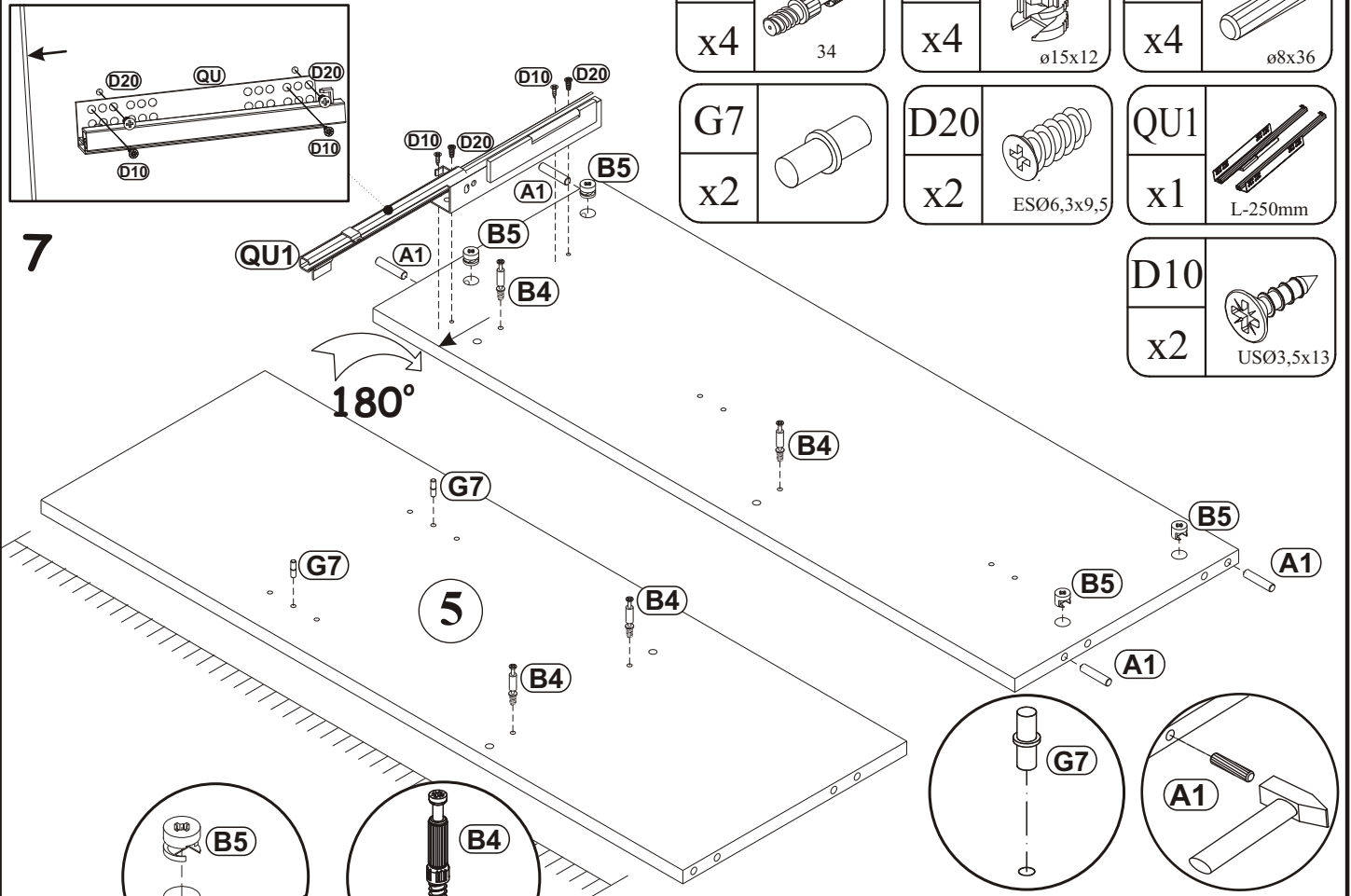

PEDRO HJZ PD __ TYP G

9

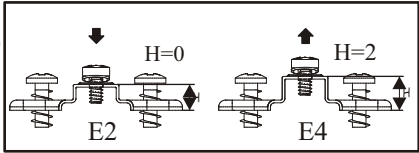

G20	
x1	

B4	
x6	34

E4	
x2	H=2

UP17	
x6	UPØ4x25

ST7	
x6	Ø50, h=25

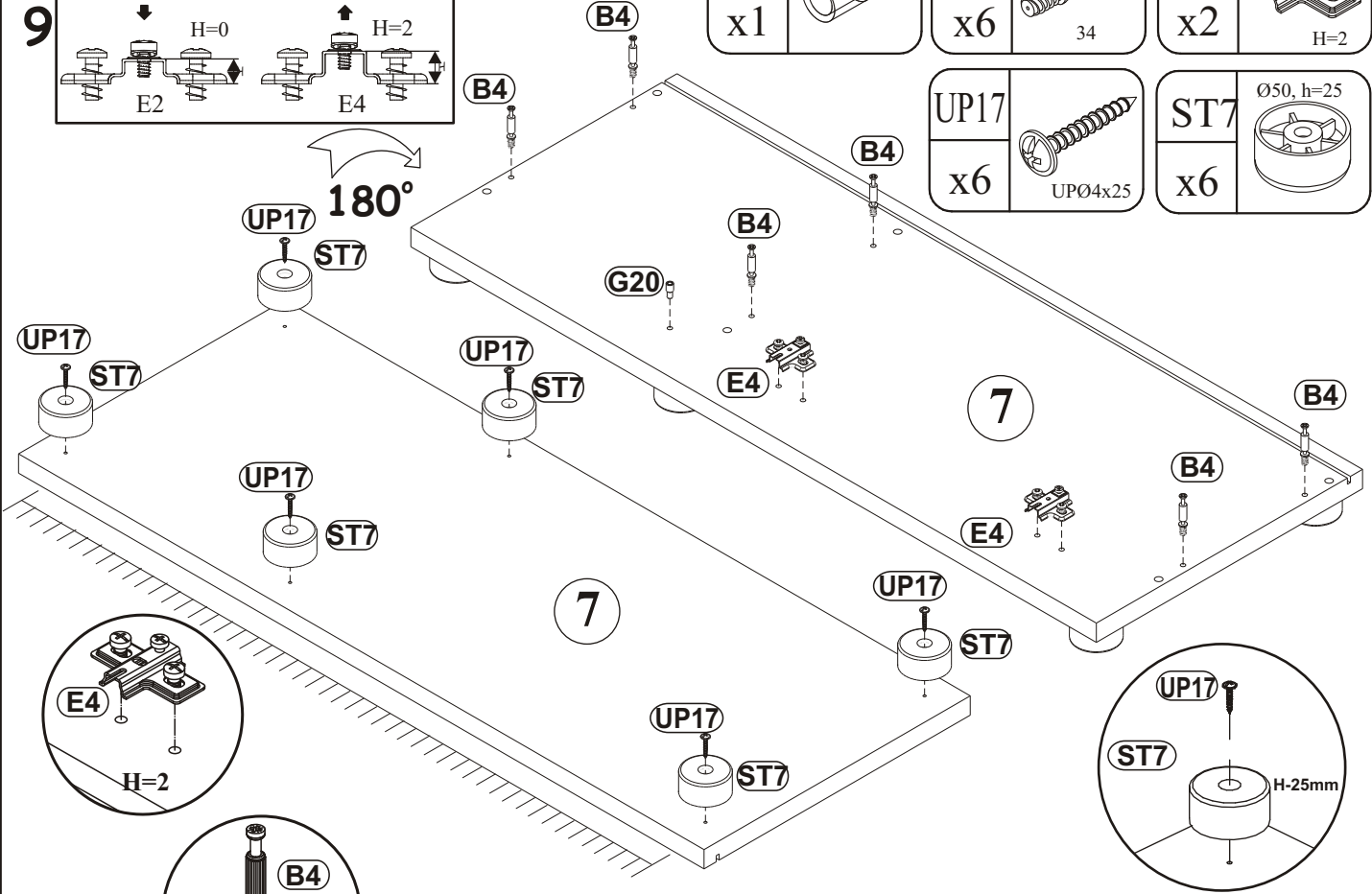

10

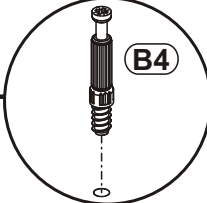

G20	
x1	

B4	
x6	34

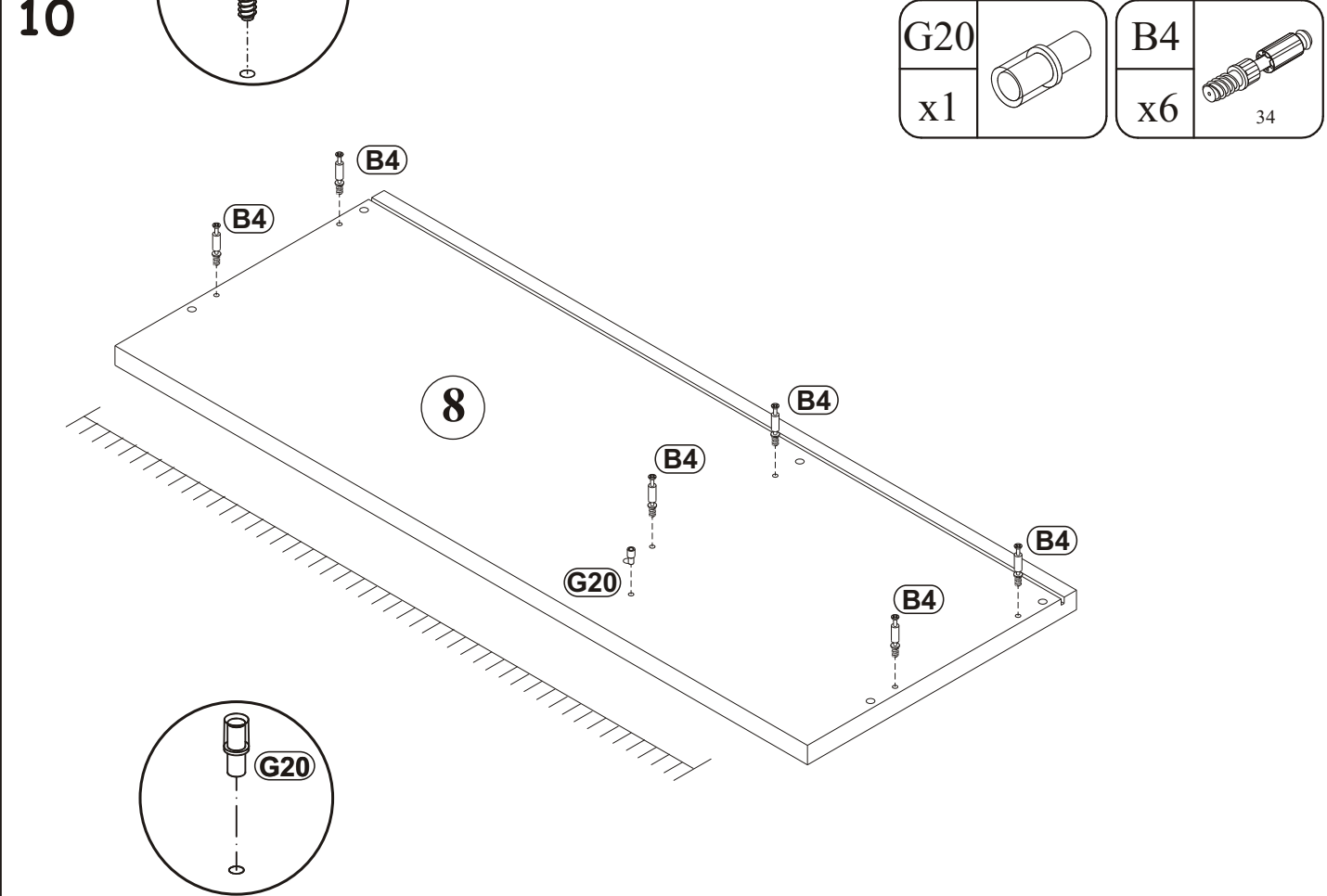

11

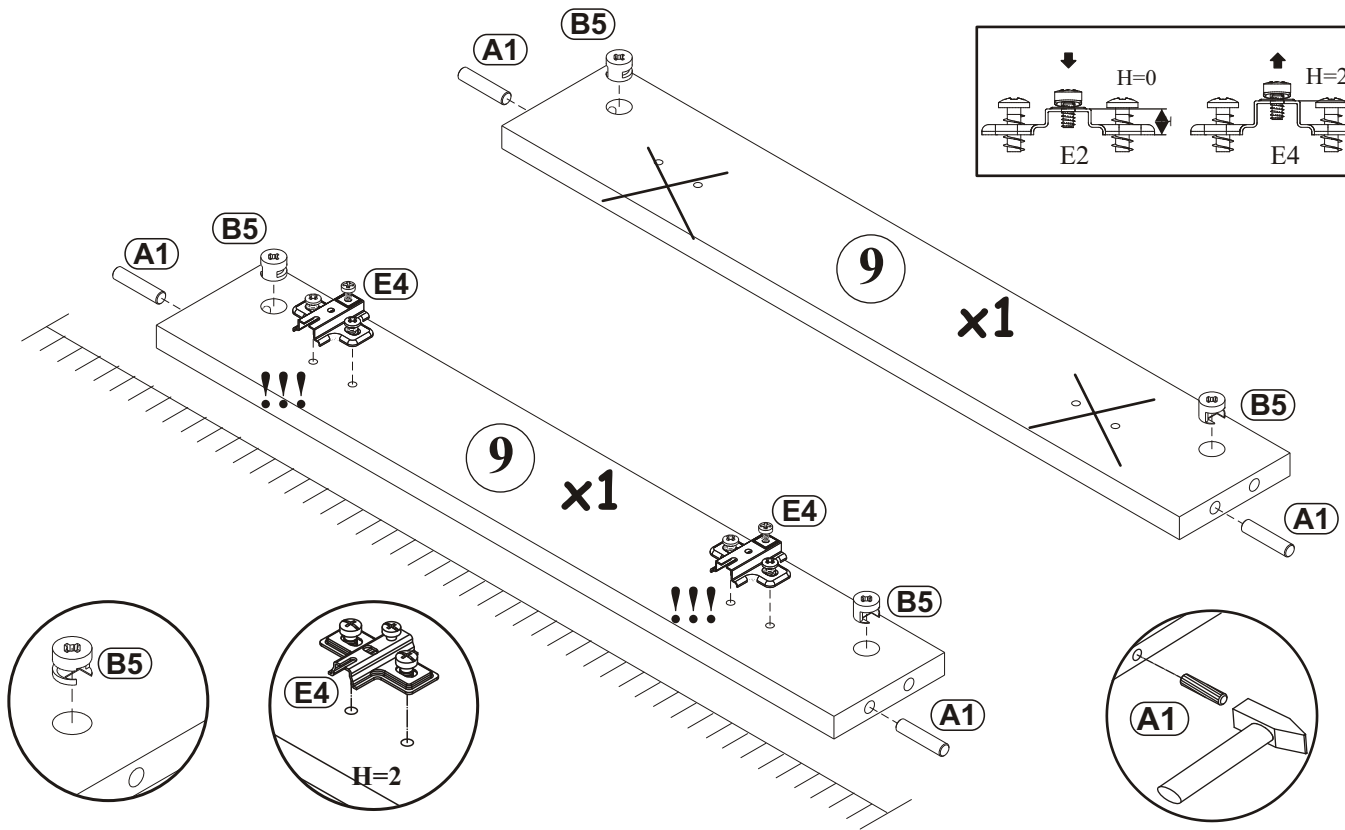
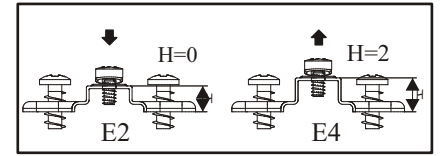
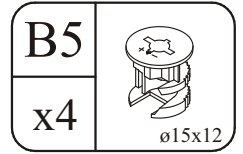
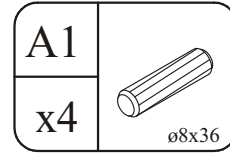
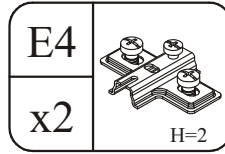

12

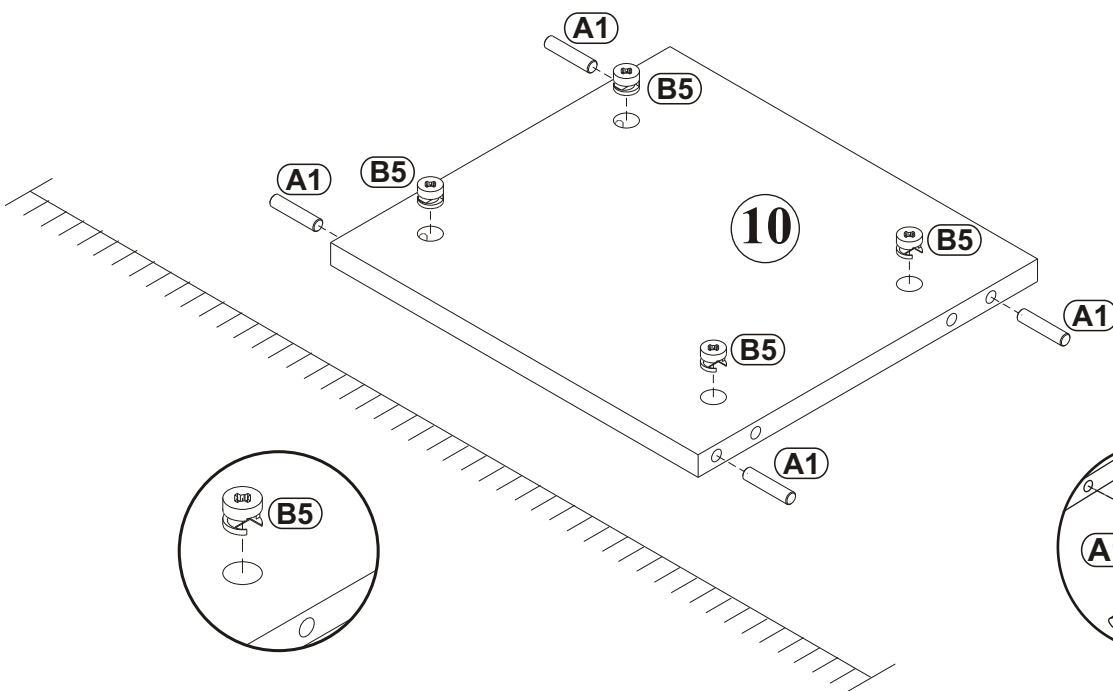
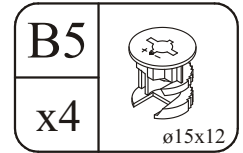
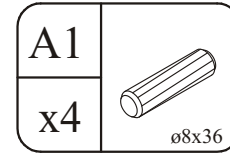

13

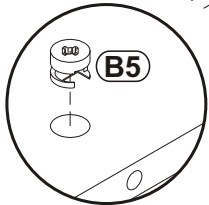
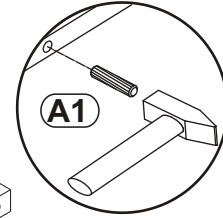
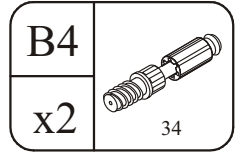
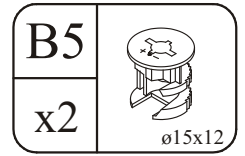
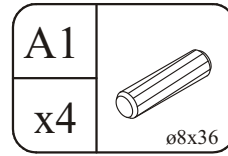
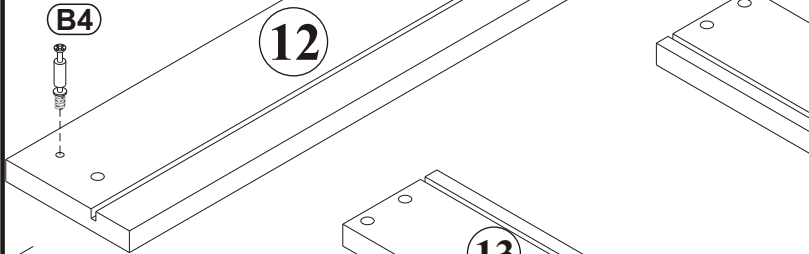
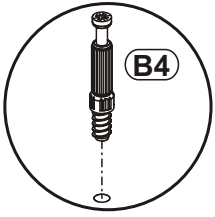

14

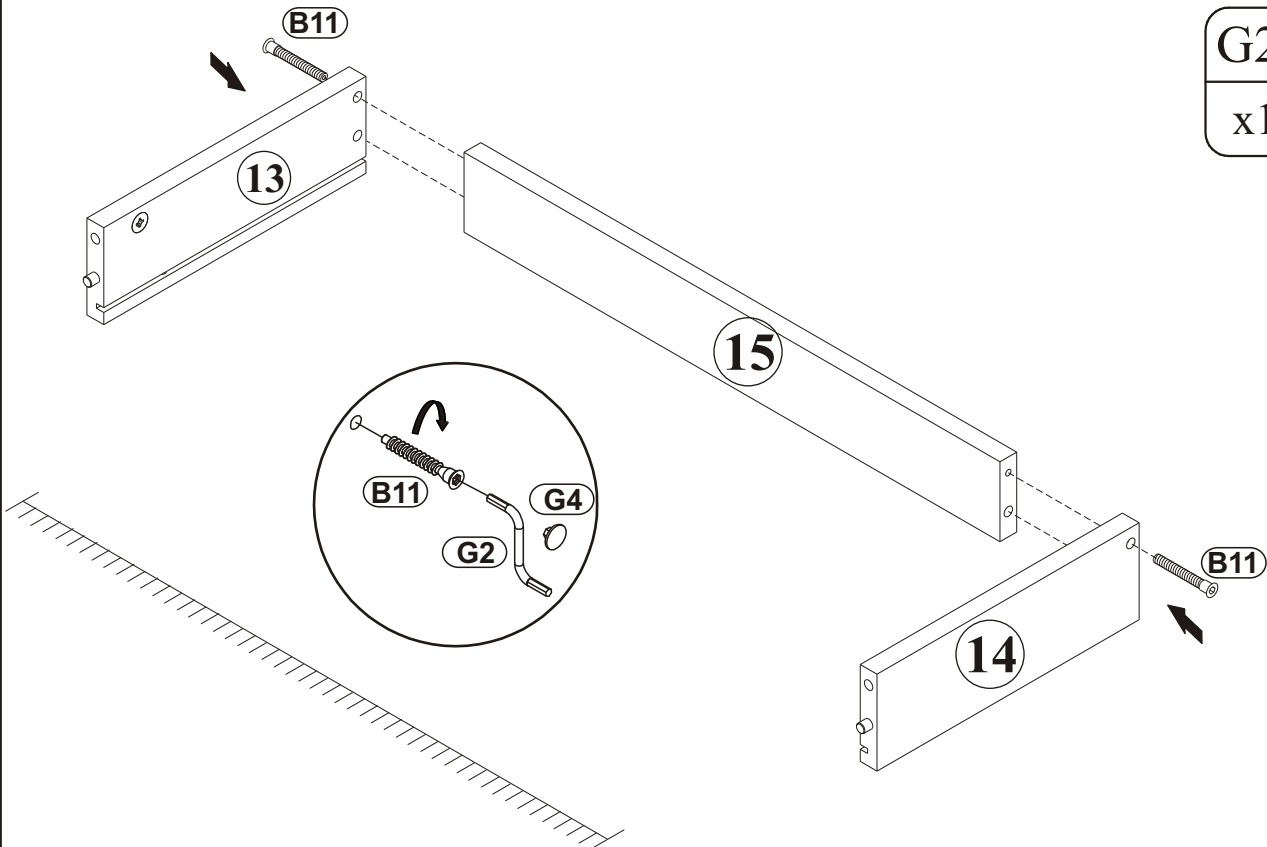
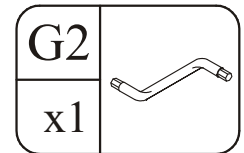
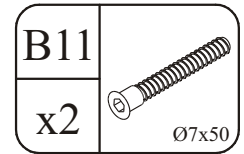
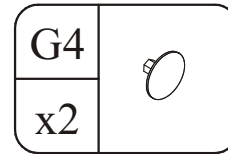

G5		G2	
x2		x1	

15

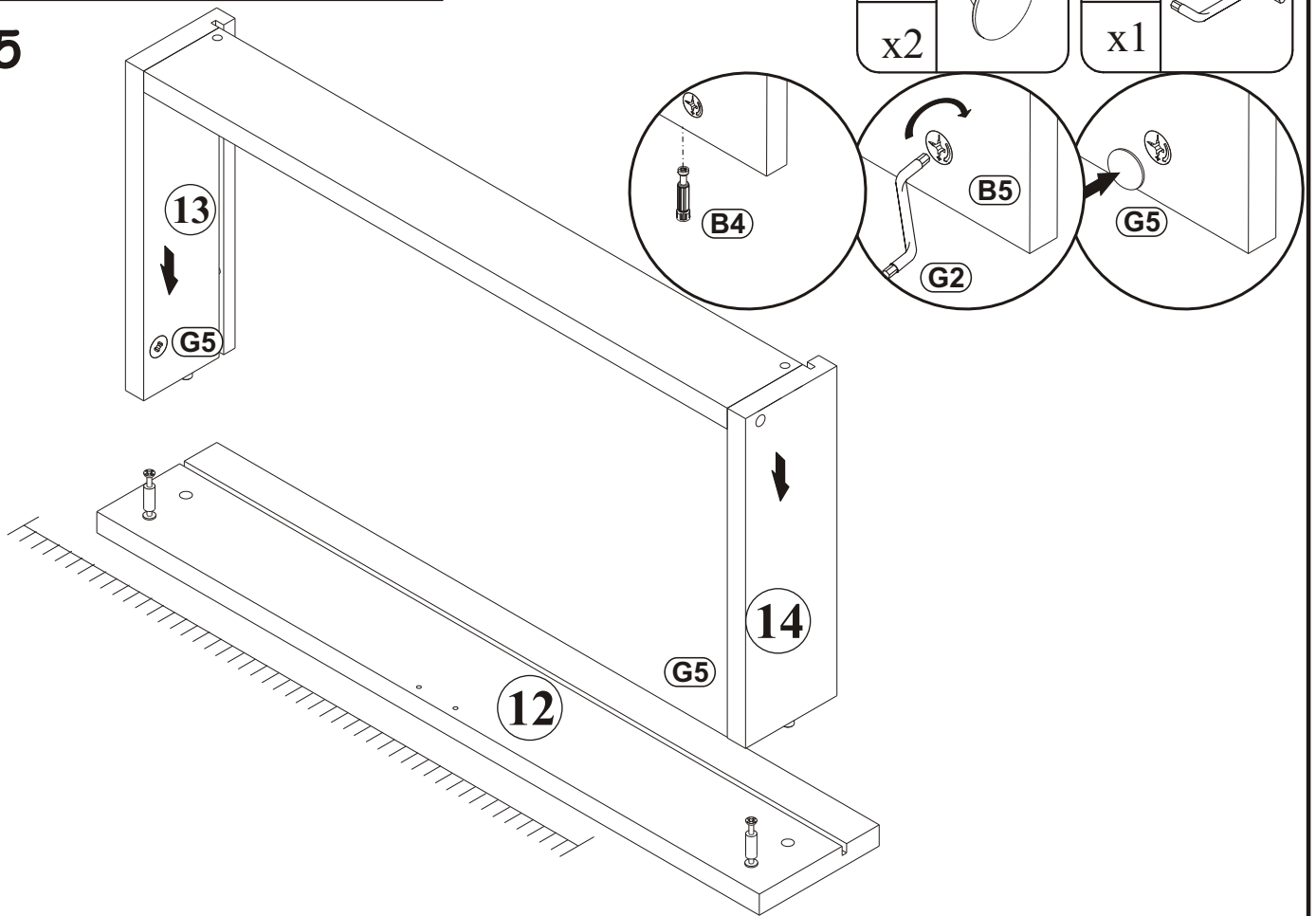

16

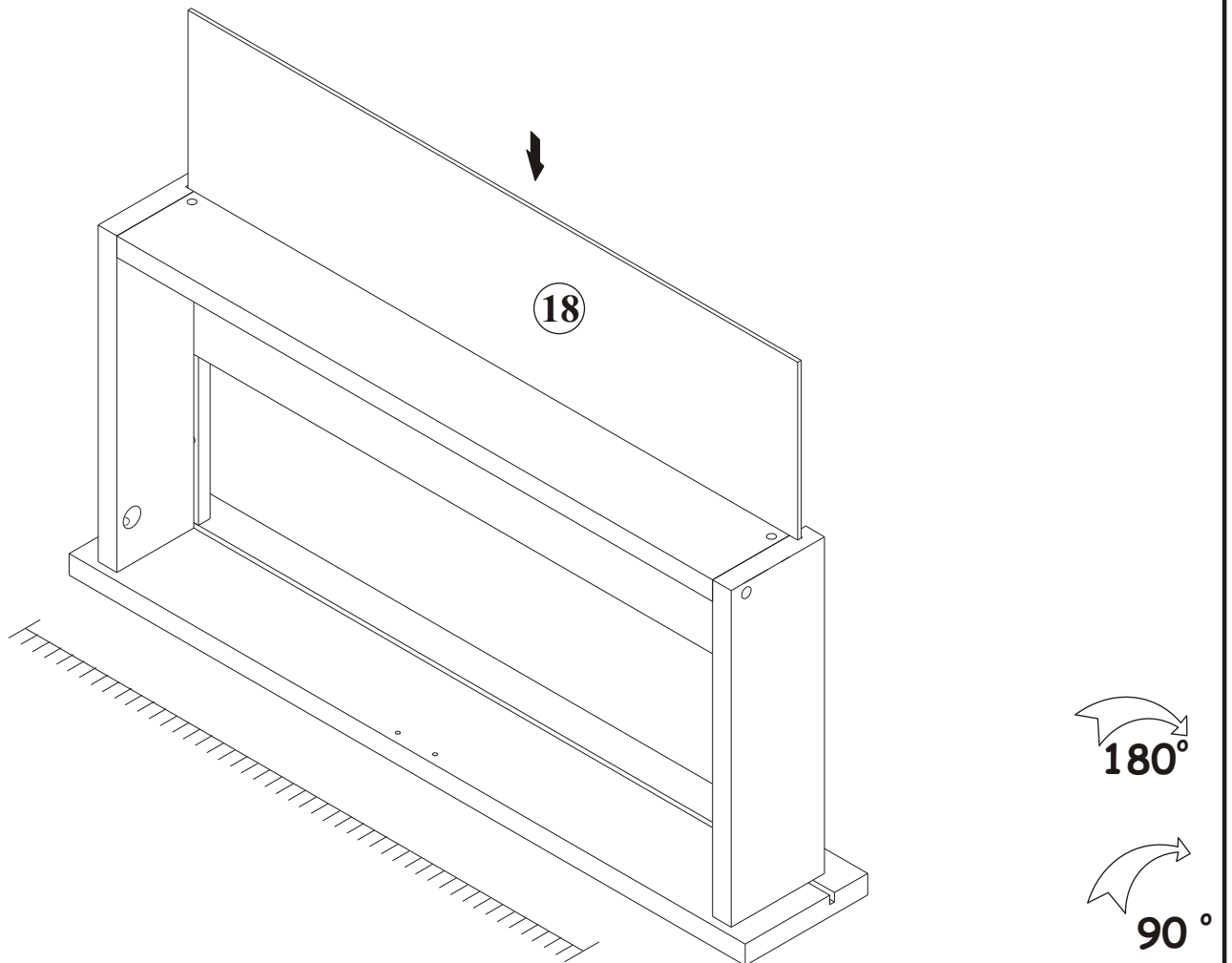

17

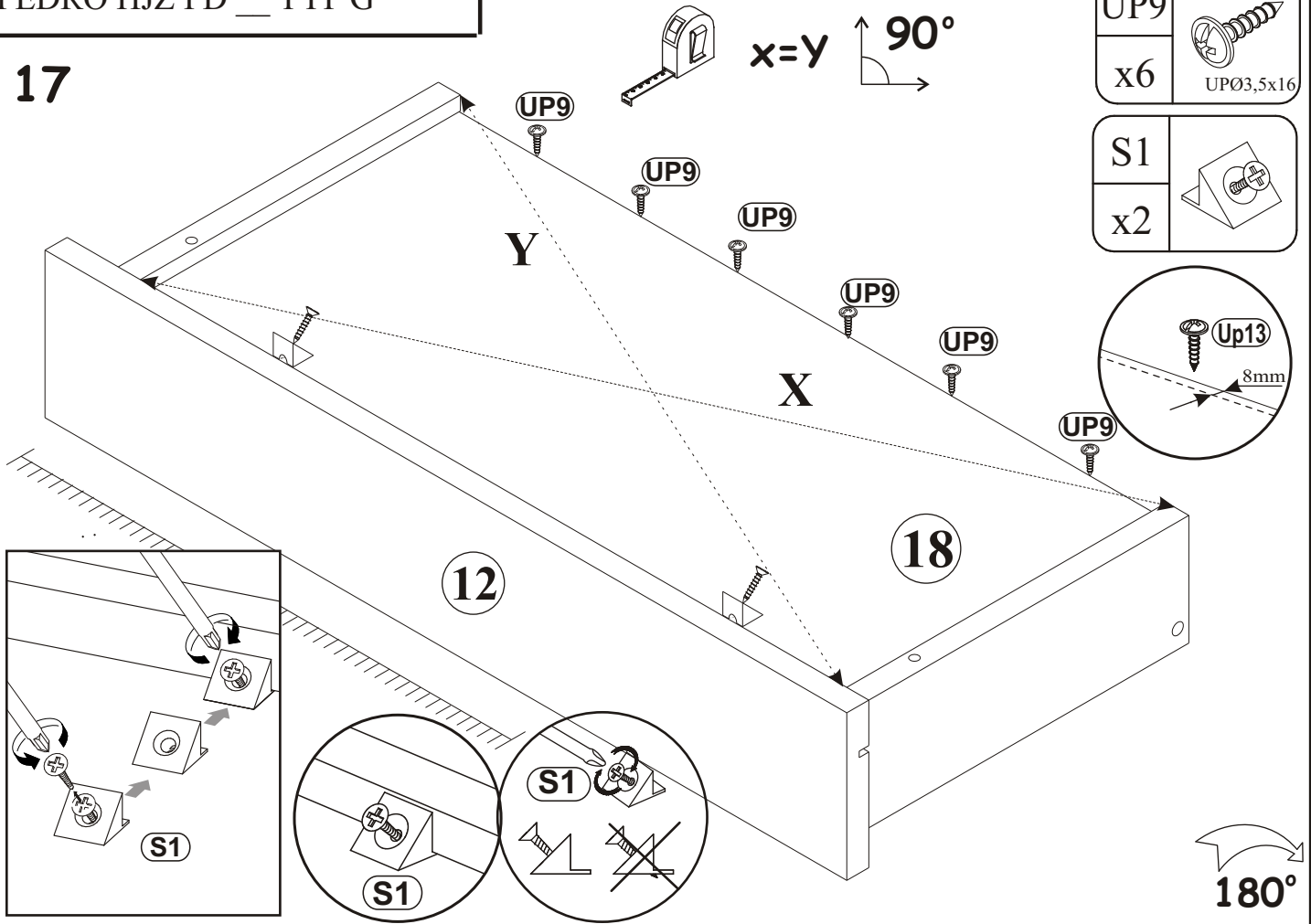

18

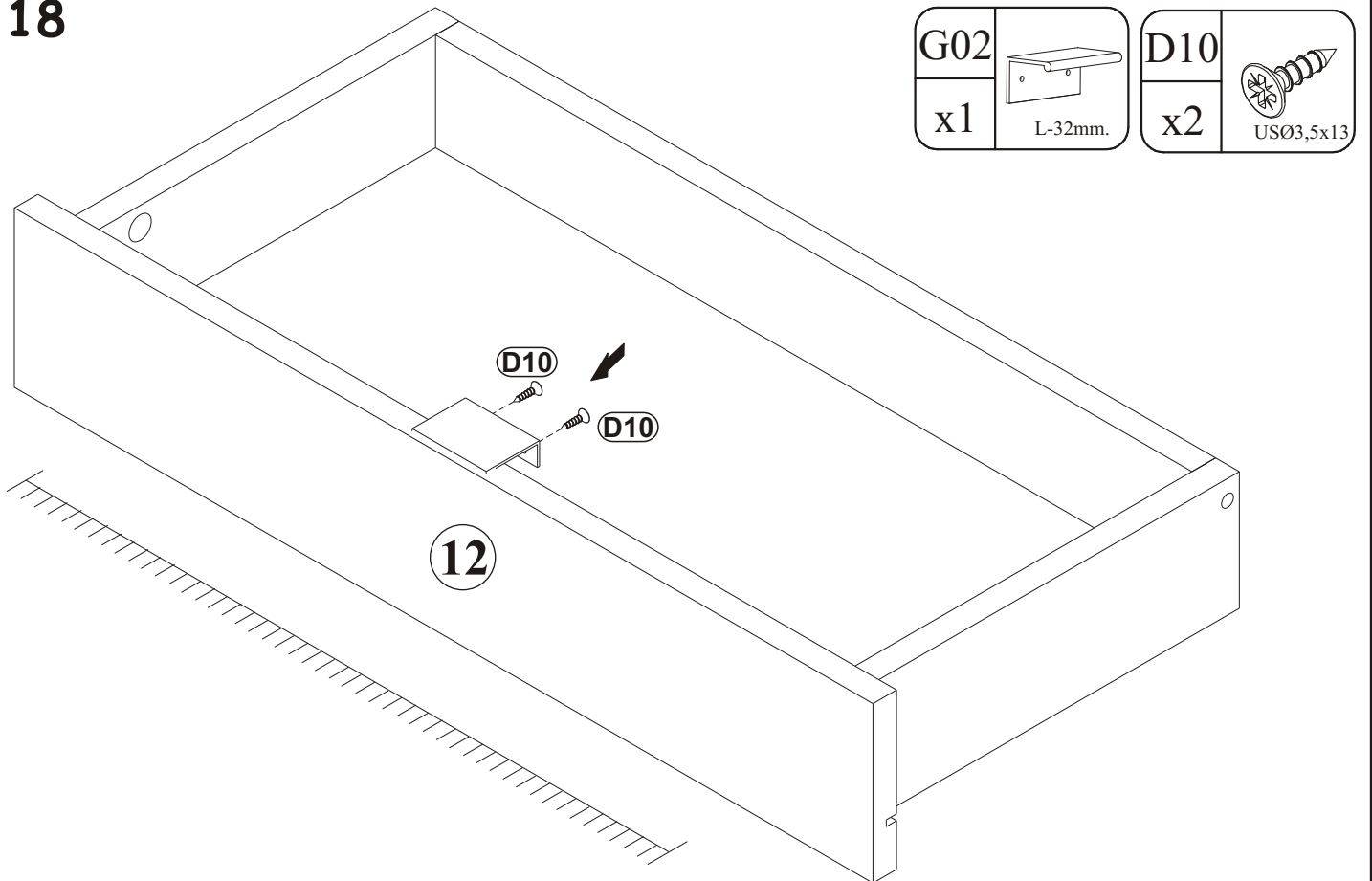

19

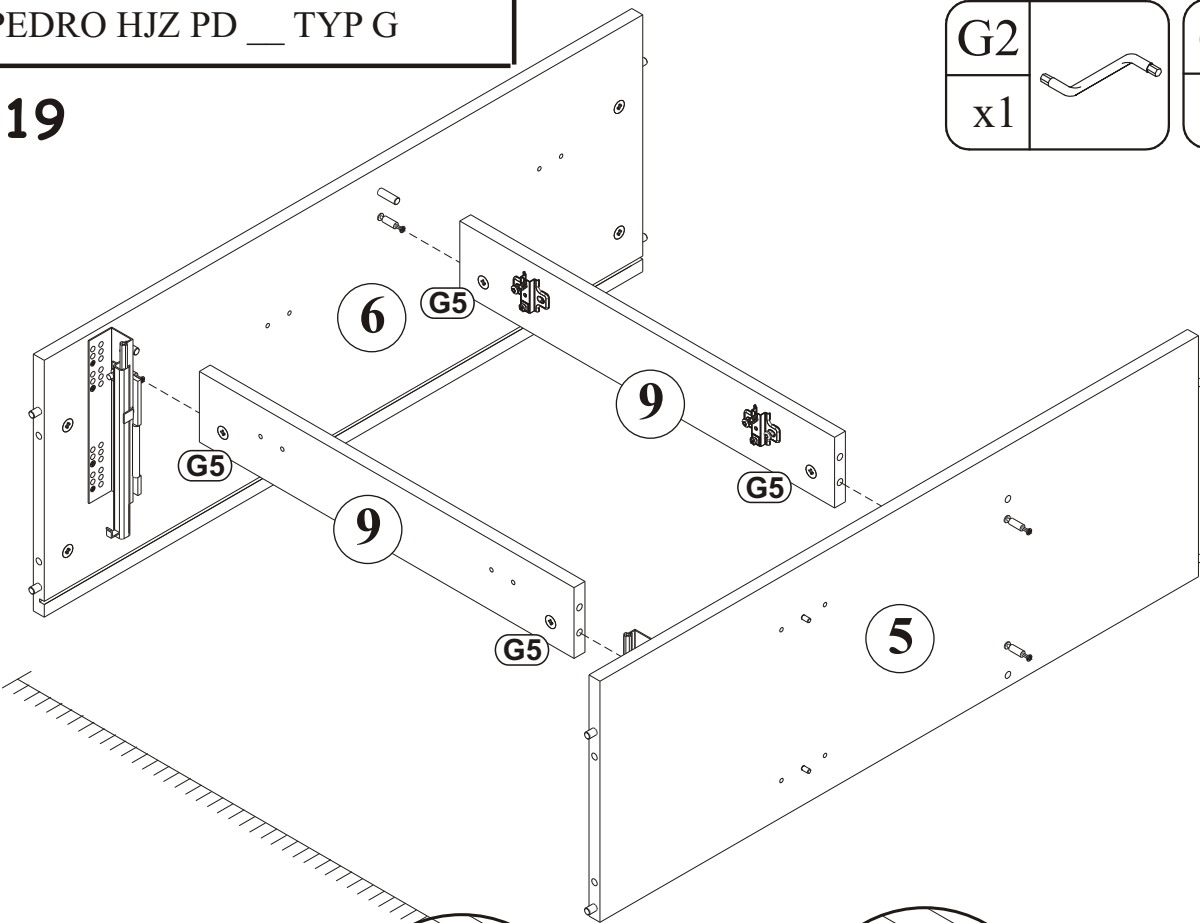

G2	
x1	

G5	
x4	

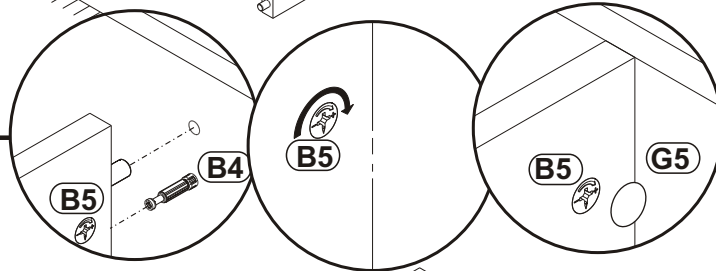

90°

20

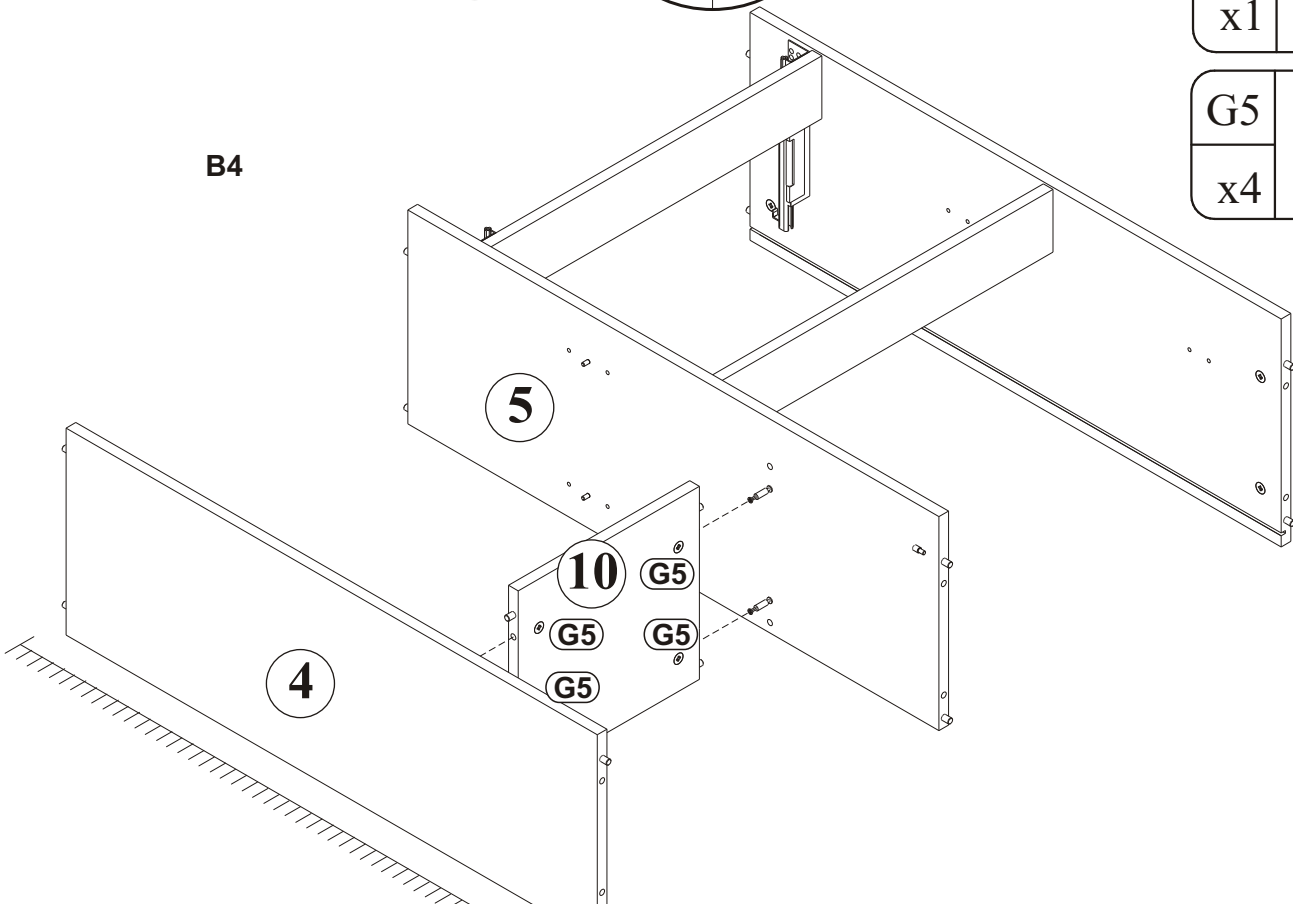

B4

G2	
x1	

G5	
x4	

G2	
x1	

G5	
x6	

21

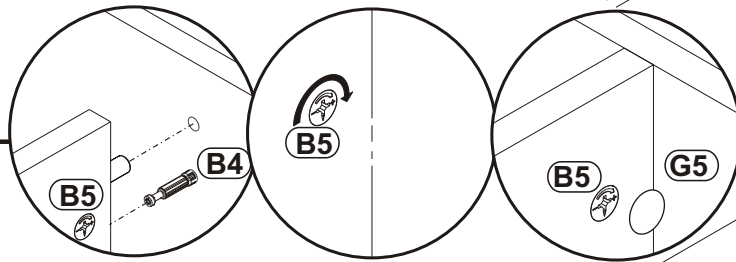
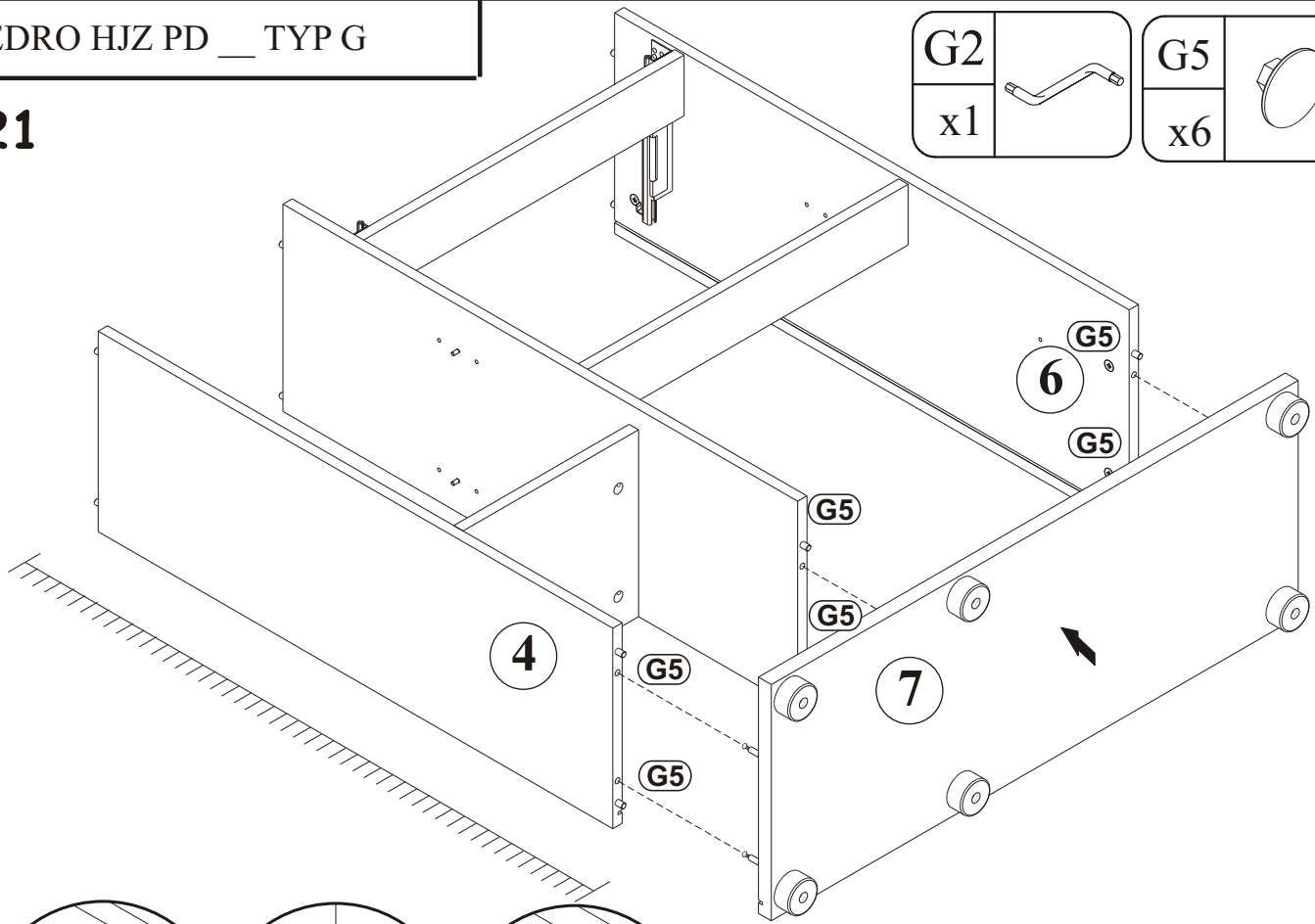

22

G2	
x1	

G5	
x6	

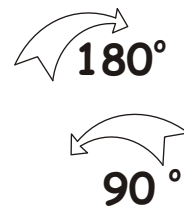
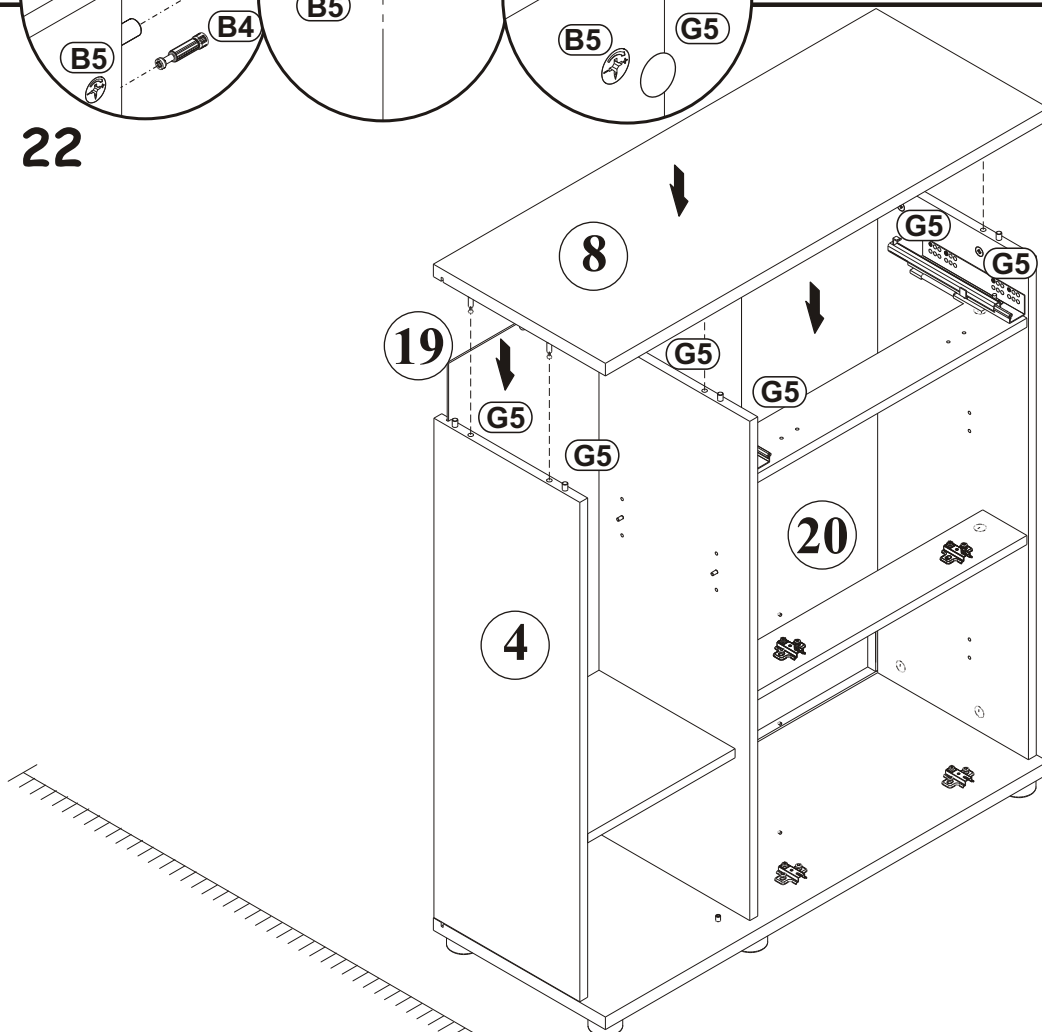

23

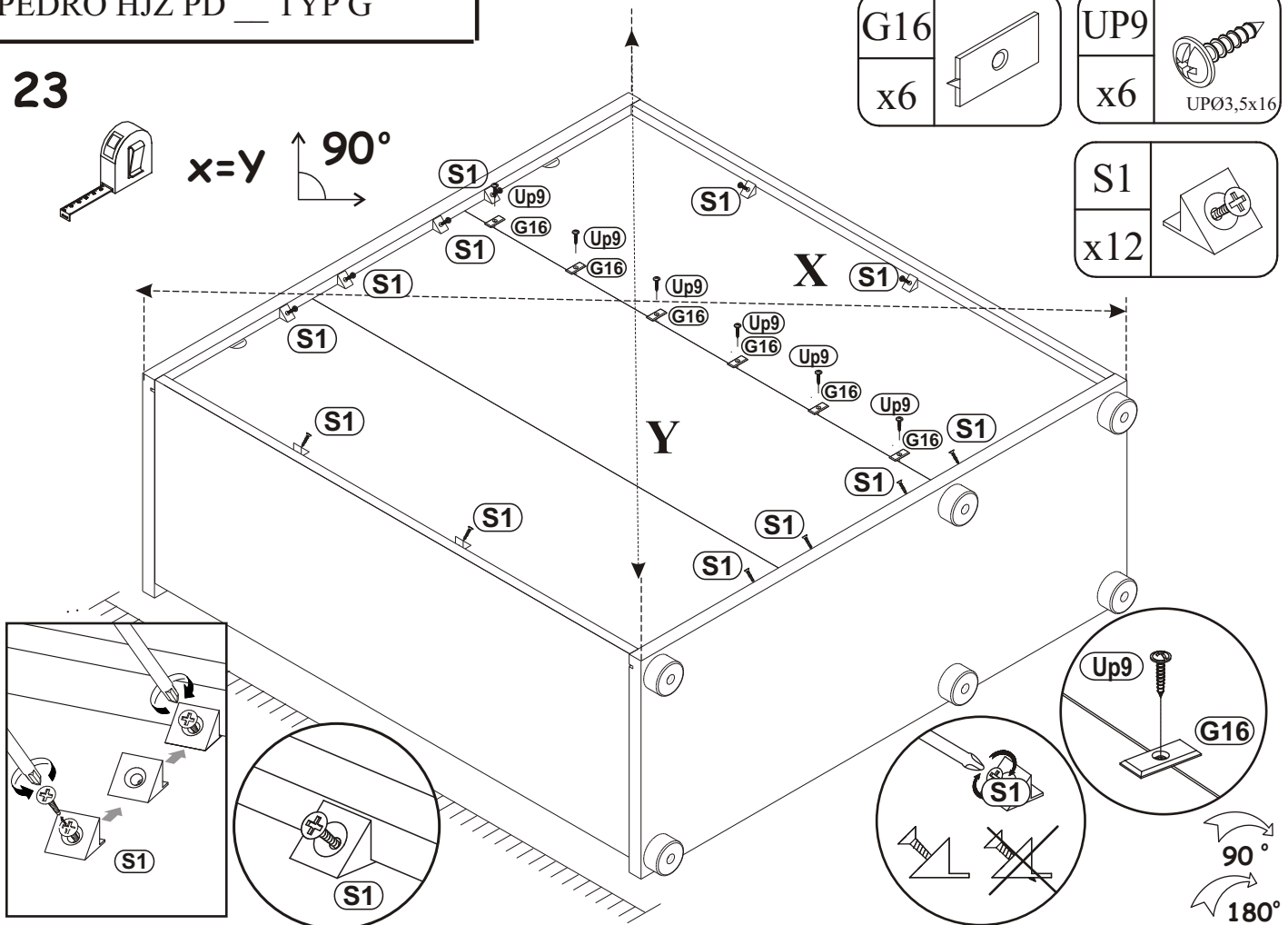

24

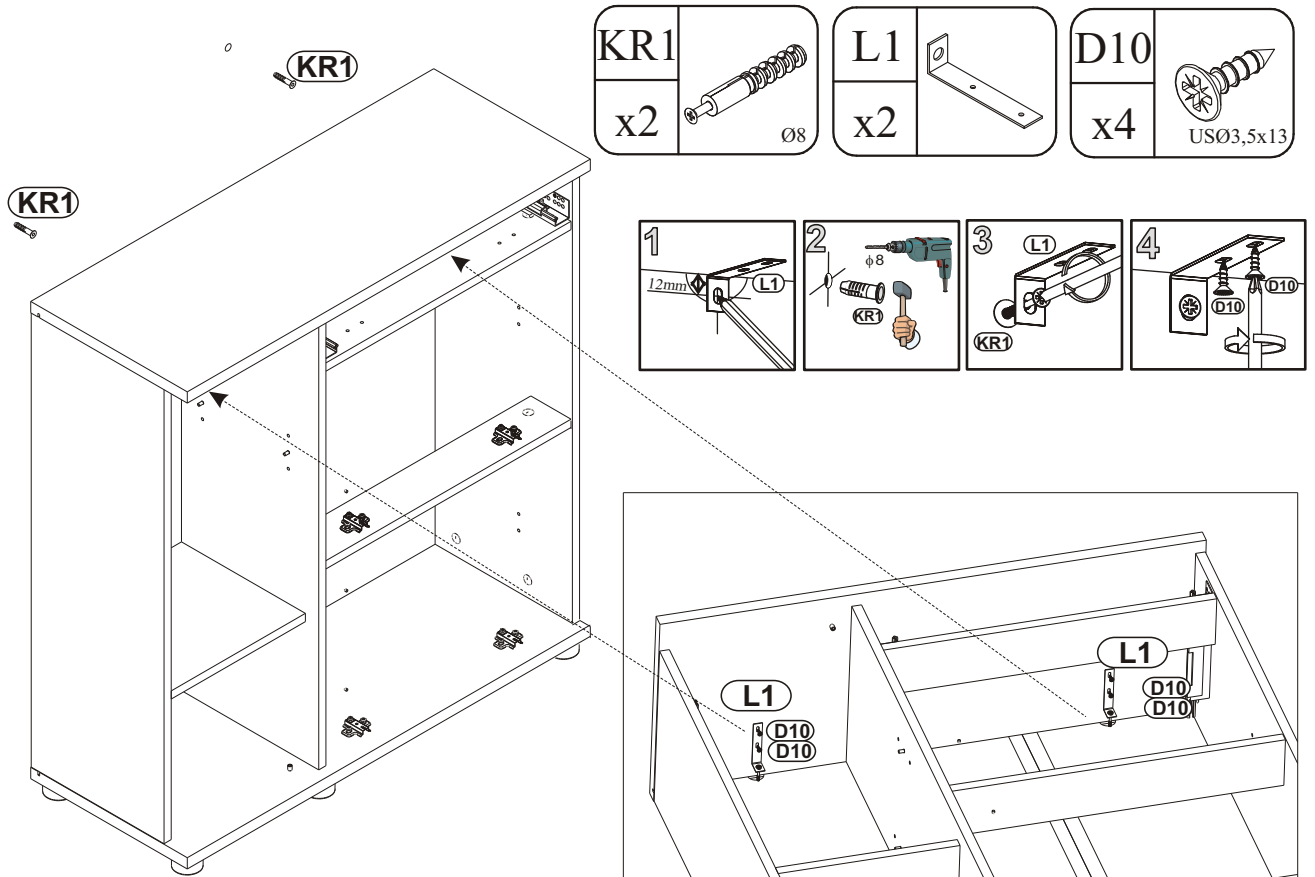

25

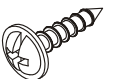
UP9	
x2	UPØ3,5x16

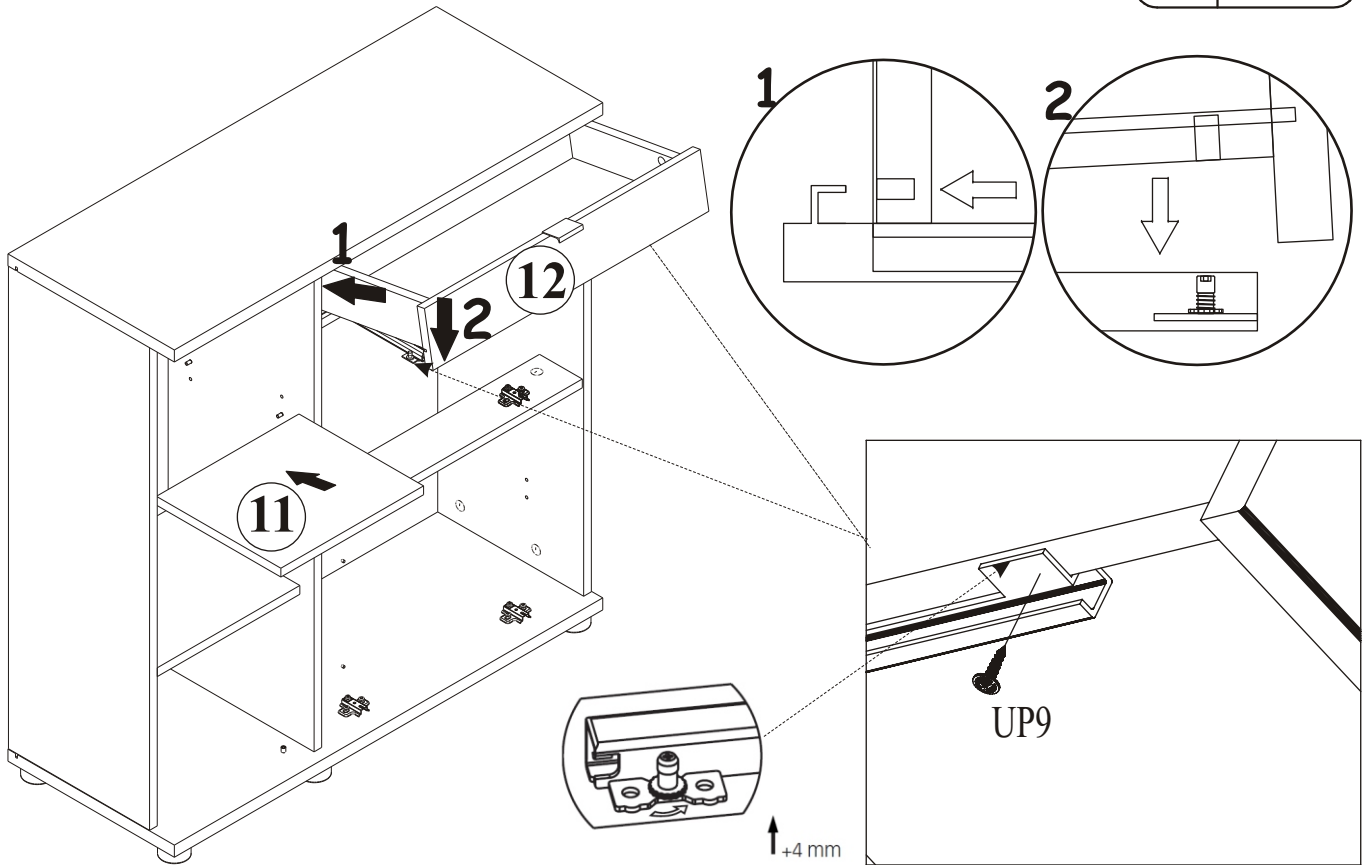

26

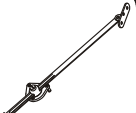
G21	
x4	

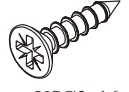
D7	
x12	USØ3x16

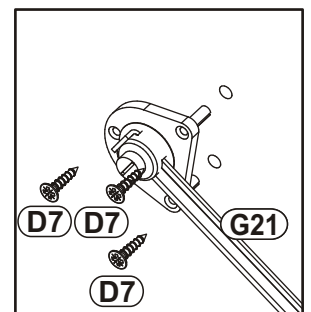
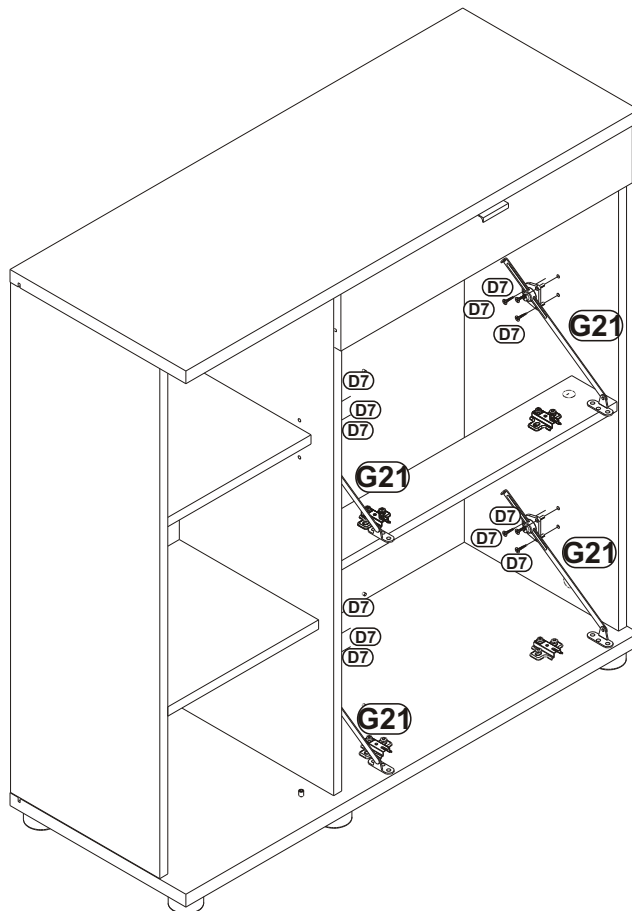

27

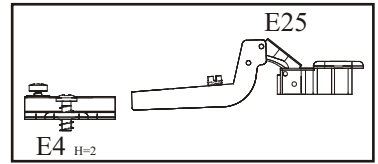
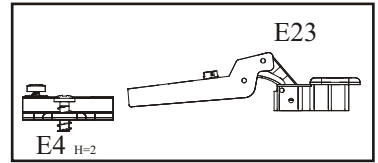
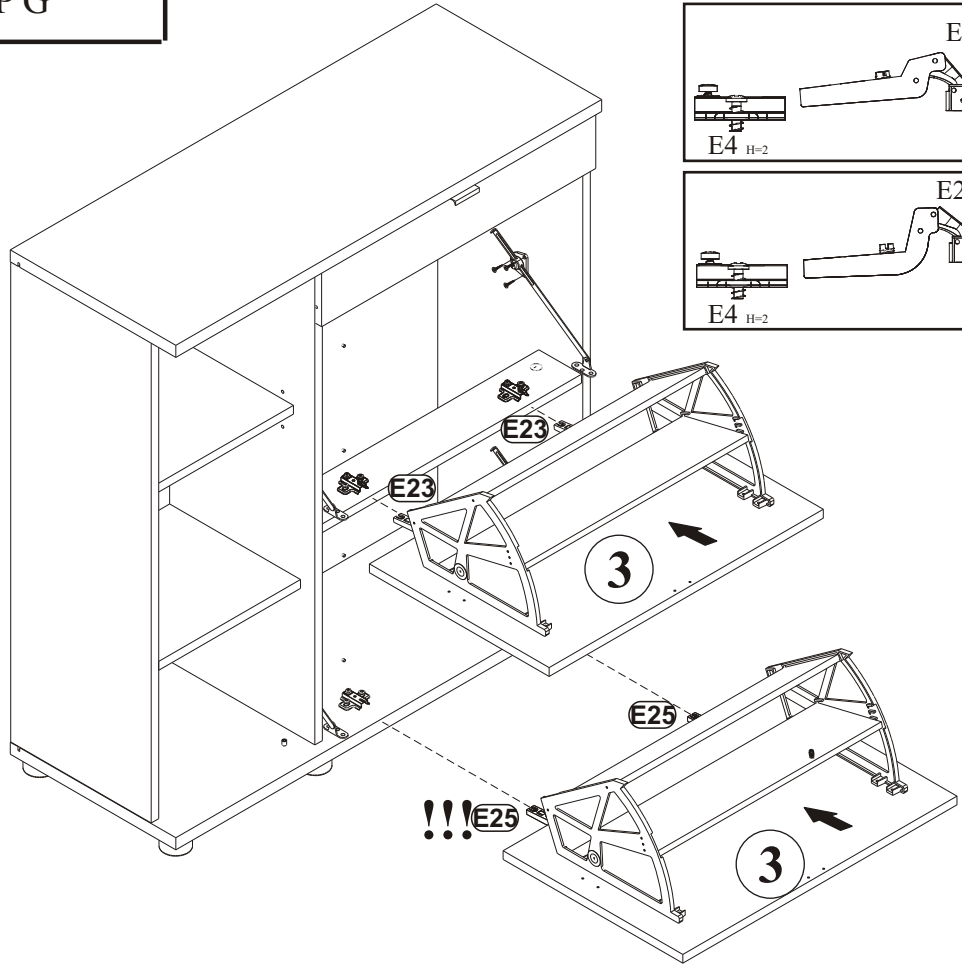
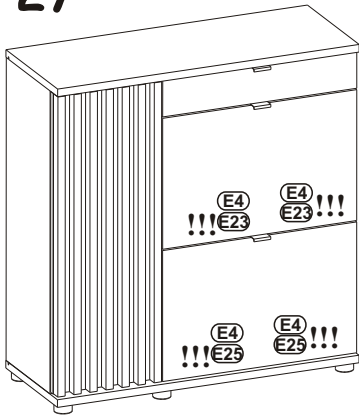

28

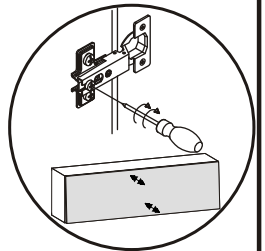
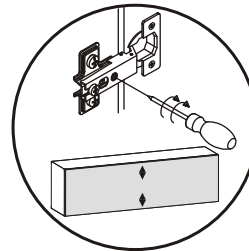
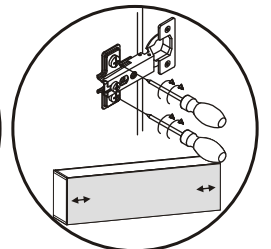
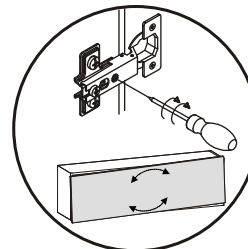
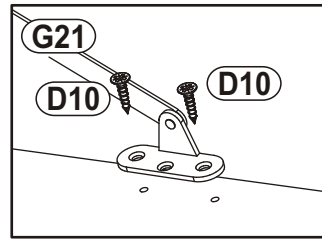
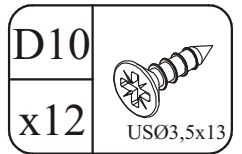
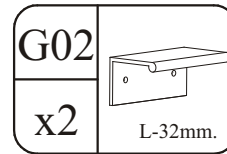
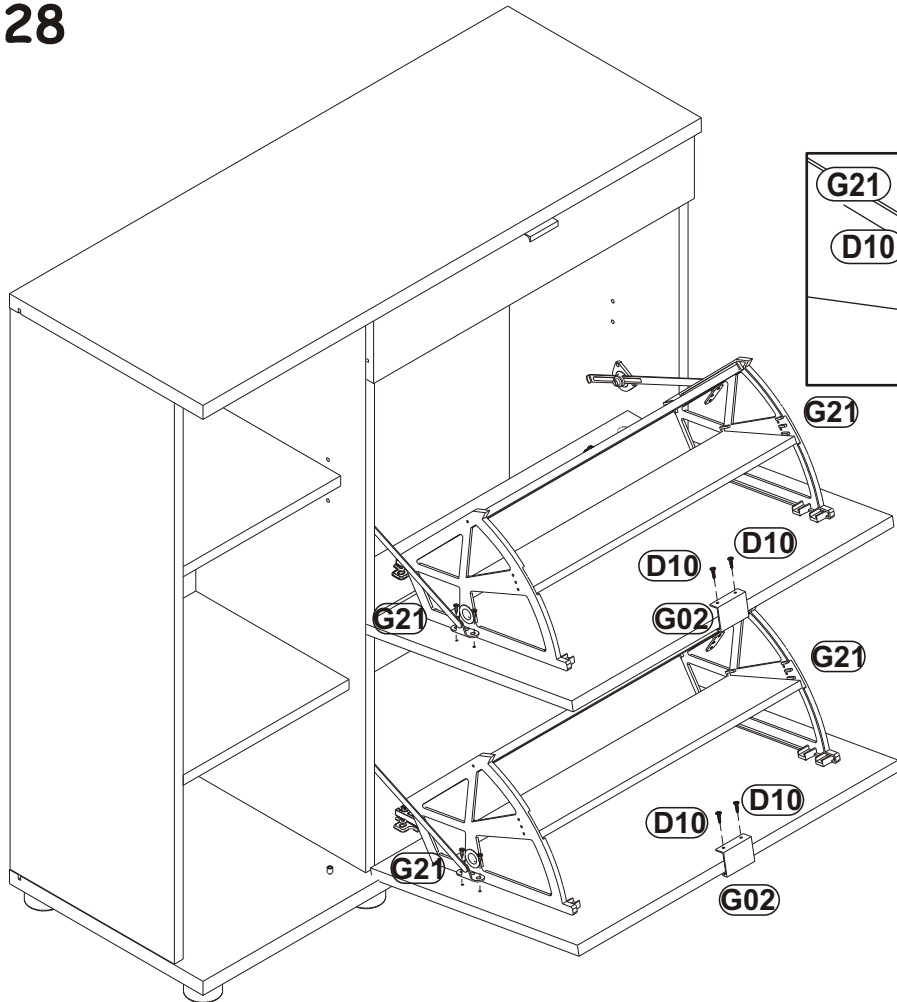

29

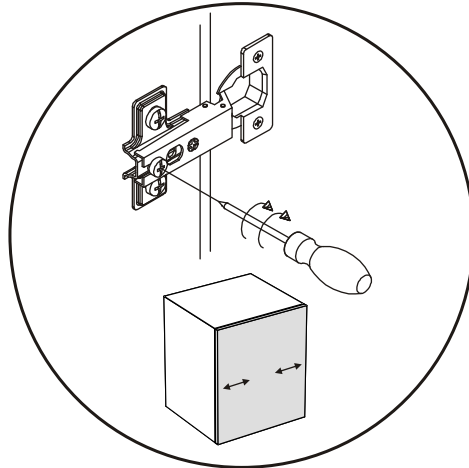
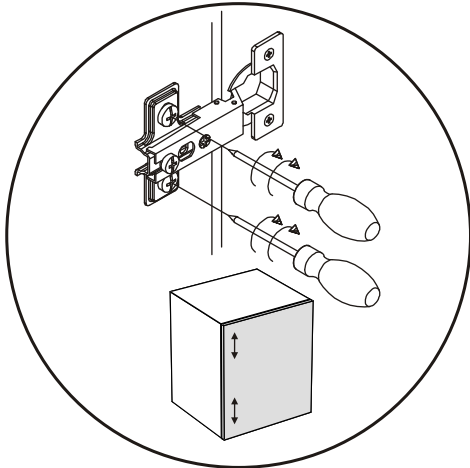
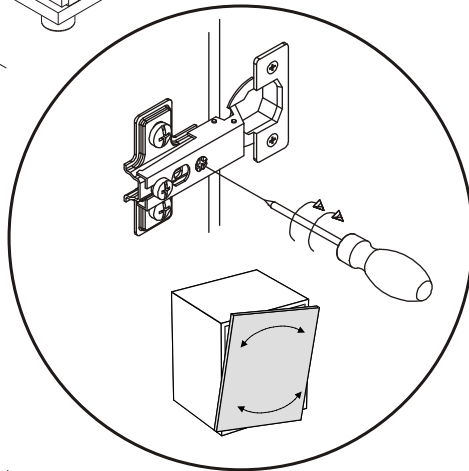
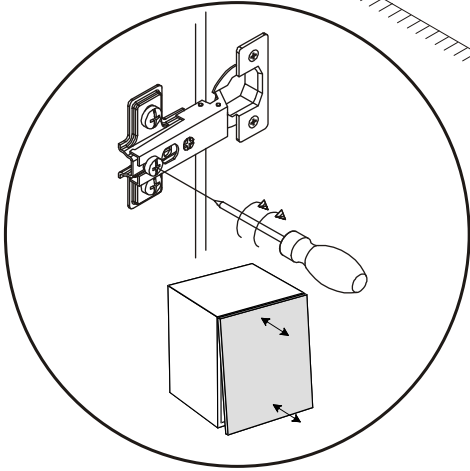
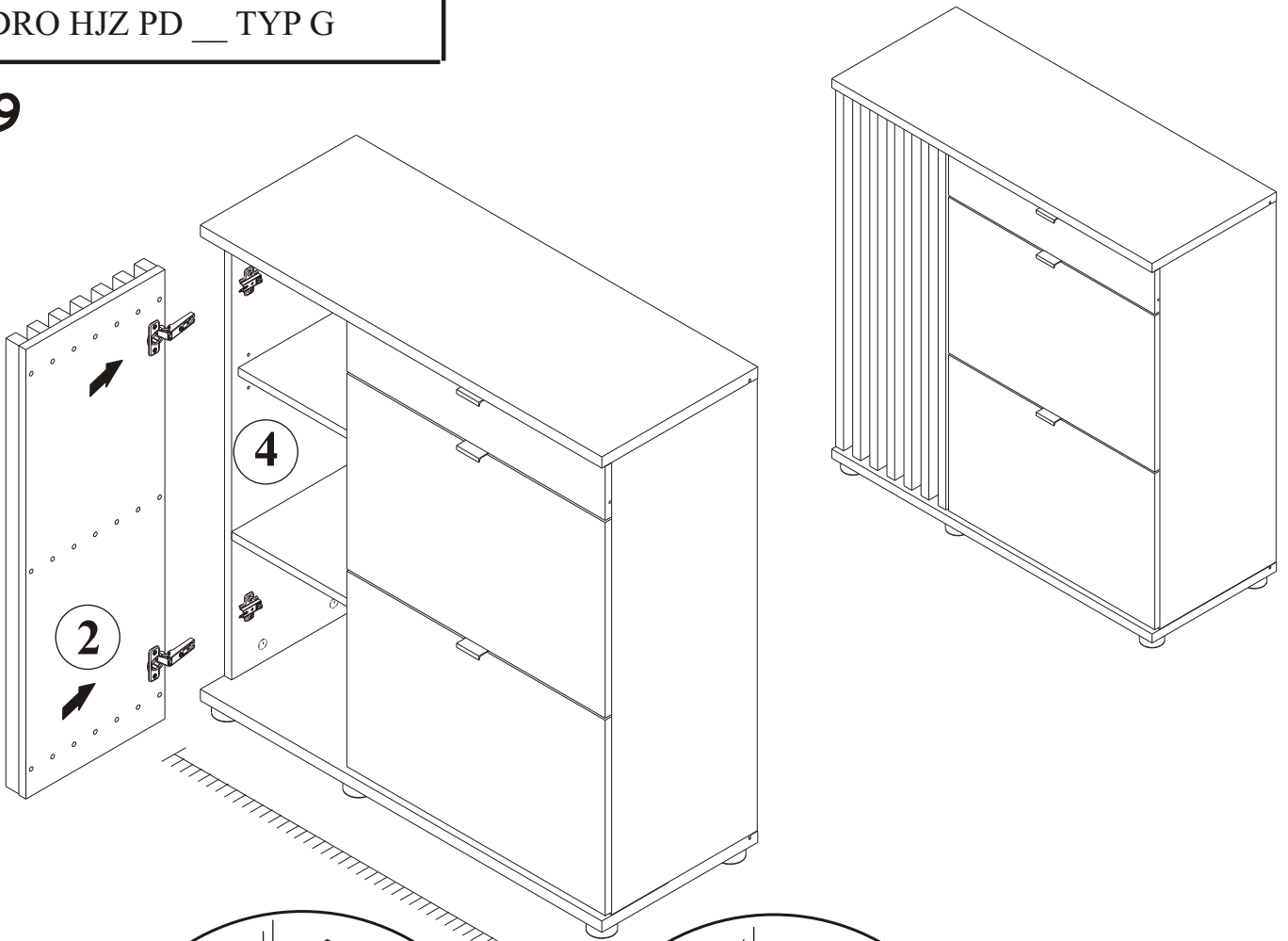

PEDRO HJZ PD ___ TYP D

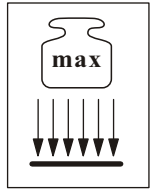
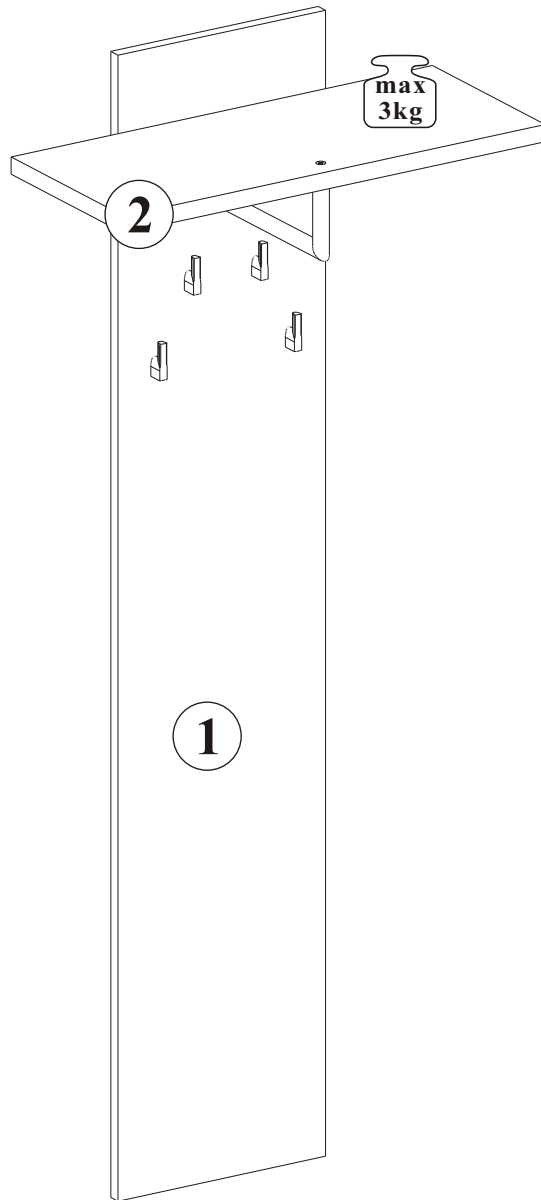

NO	DIM [mm]		COL.-NO	QTY
1	296	1460	16 1/1	1
2	601	250	22 1/1	1

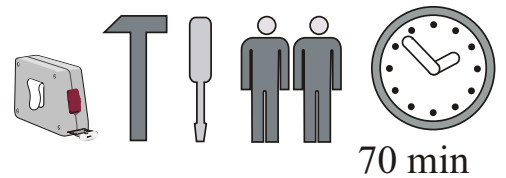





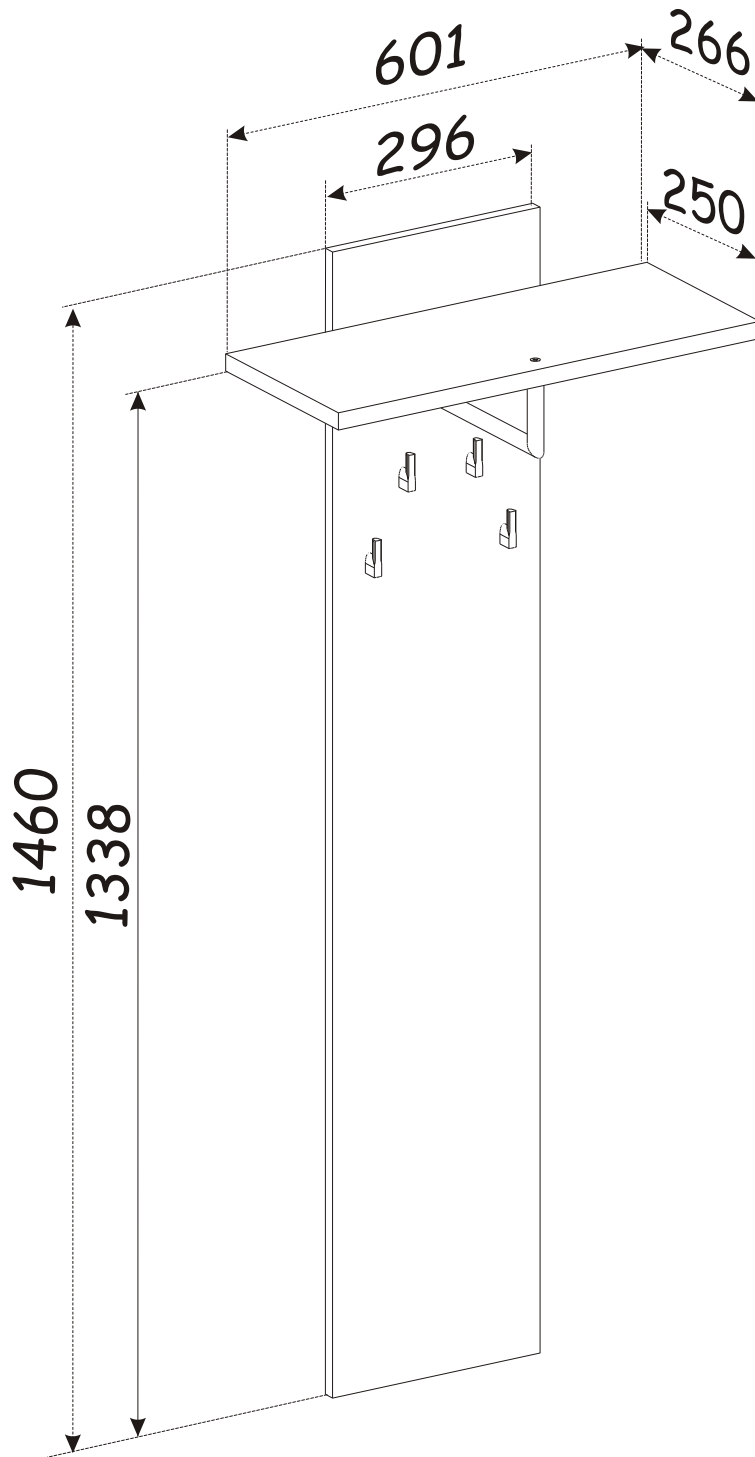

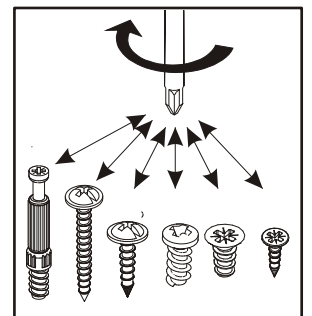
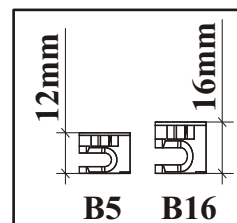
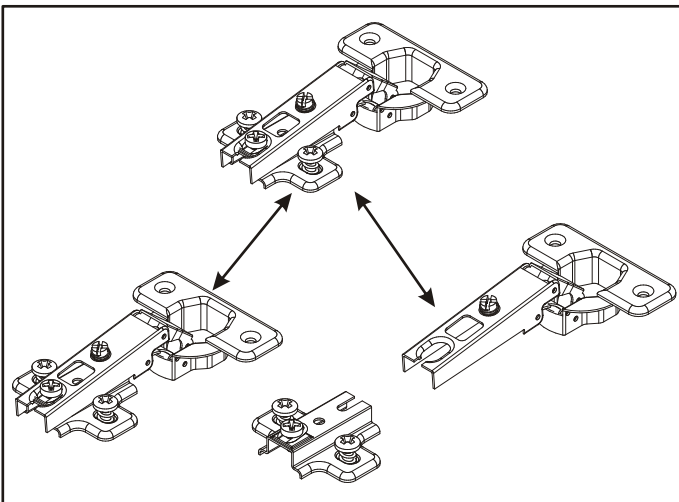
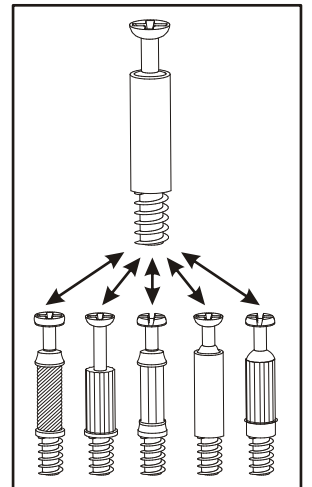
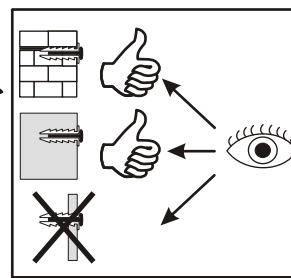
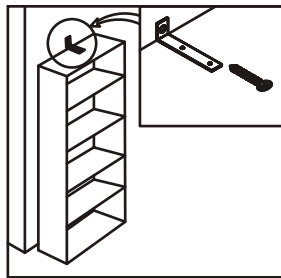
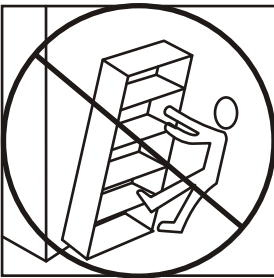
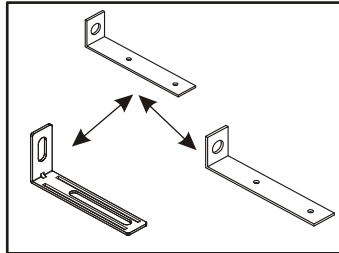
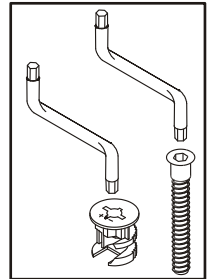
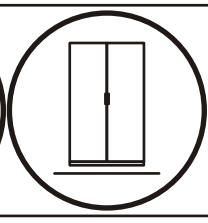
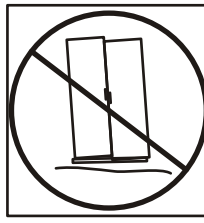
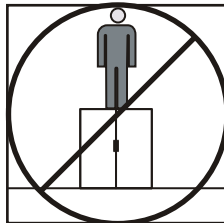
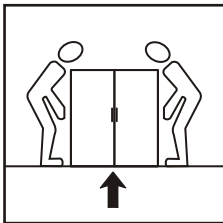
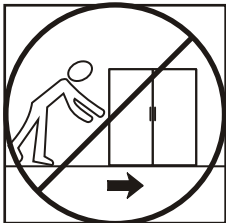
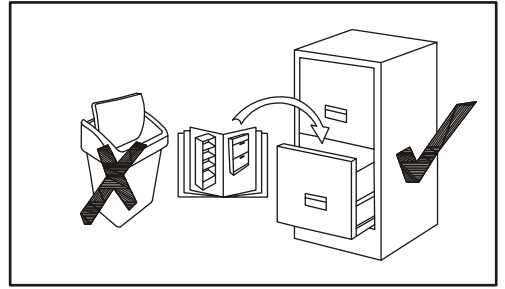
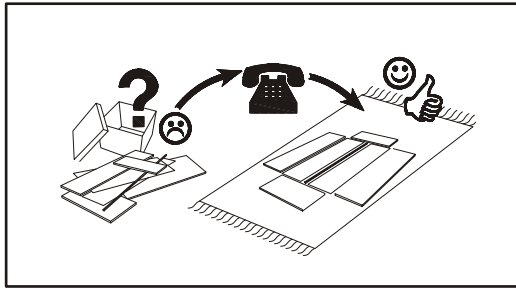
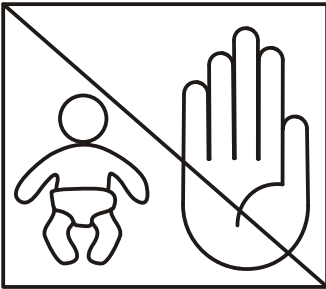
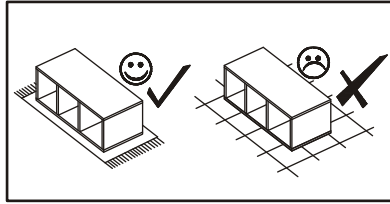
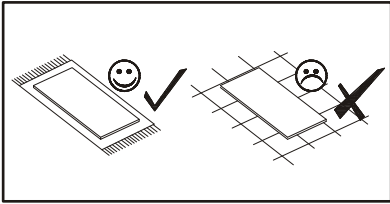
70 min

PEDRO HJZ PD _ TYP D



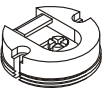
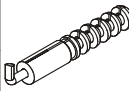
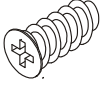
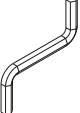
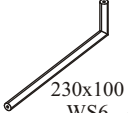

PEDRO HJZ PD _ TYP D

<p>B11</p> <p>x5</p>	 <p>Ø7x50</p>	<p>G4</p> <p>x5</p>	 <p>C</p>	<p>ZM1</p> <p>x3</p>		<p>KR3</p> <p>x3</p>	 <p>Ø10</p>	<p>D20</p> <p>x6</p>	 <p>ESØ6,3x9,5</p>	<p>G2</p> <p>x1</p>	
<p>WL3</p> <p>x1</p>	 <p>230x100 WS6</p>	<p>WS5</p> <p>x2</p>	 <p>WS6x30</p>	<p>WS1</p> <p>x4</p>		<p>UP6</p> <p>x8</p>	 <p>UPØ4x30</p>				

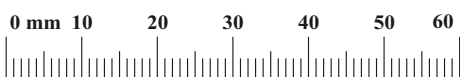

1

ZM1		D20	
x3		x6	ESØ6,3x9,5

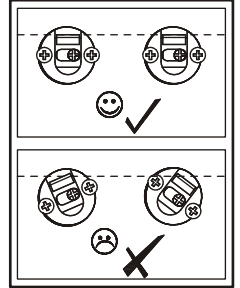
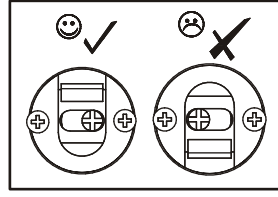
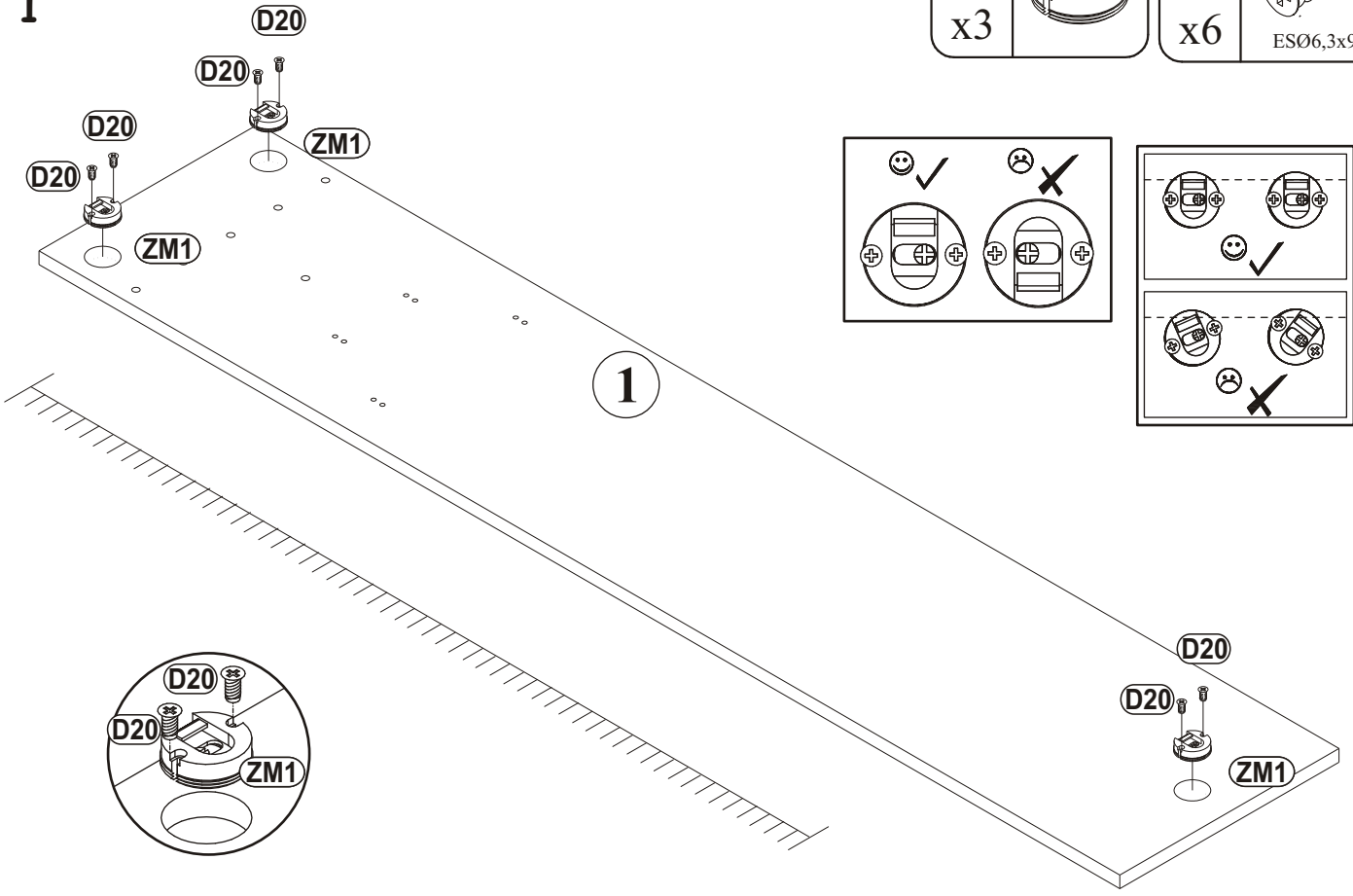

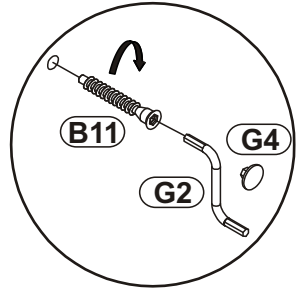
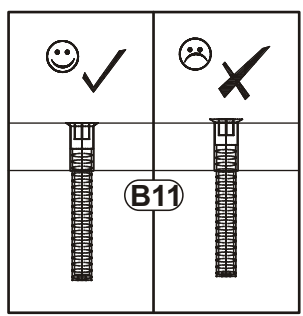
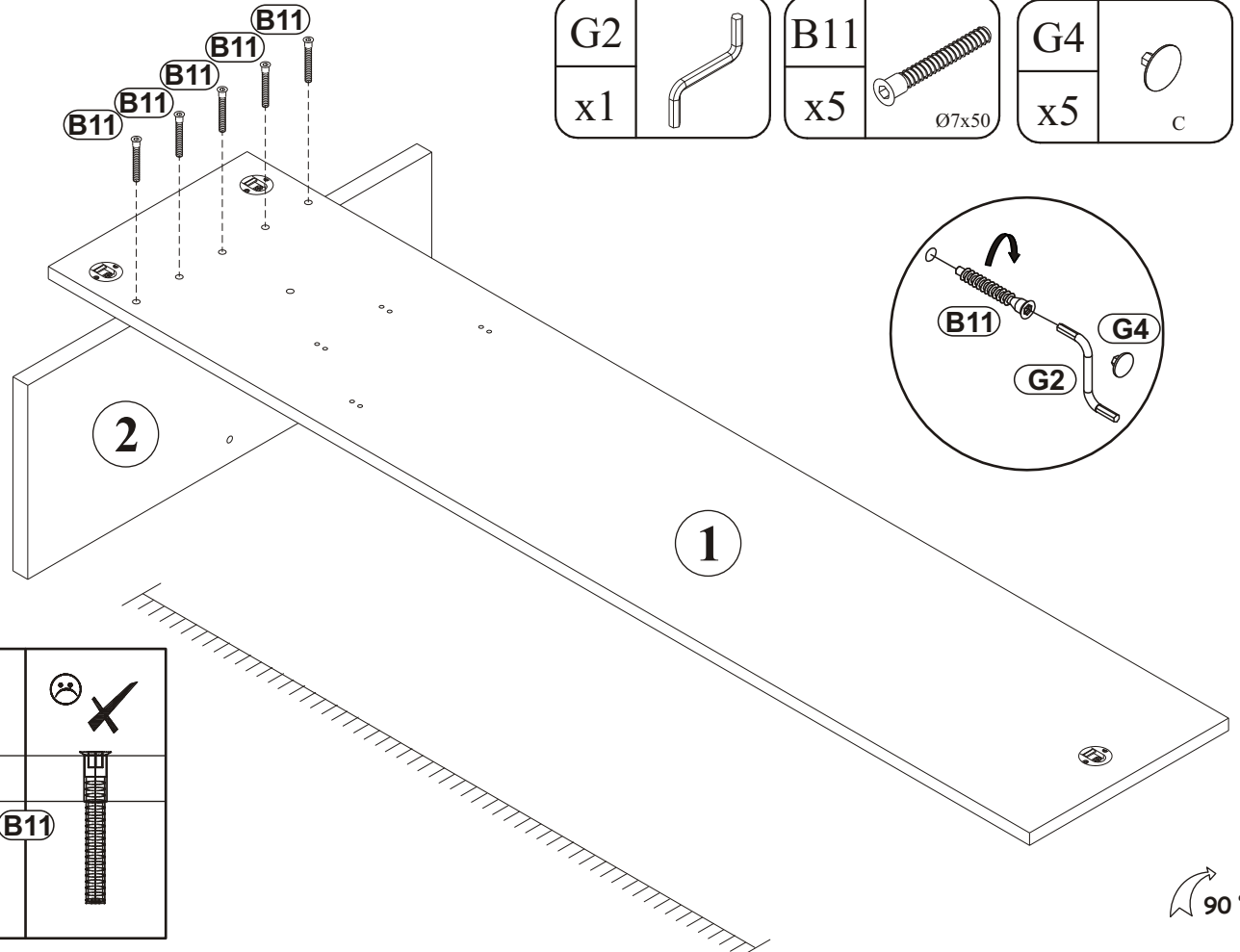

2

G2		B11		G4	
x1		x5	Ø7x50	x5	C



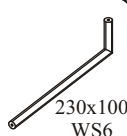

90°

3

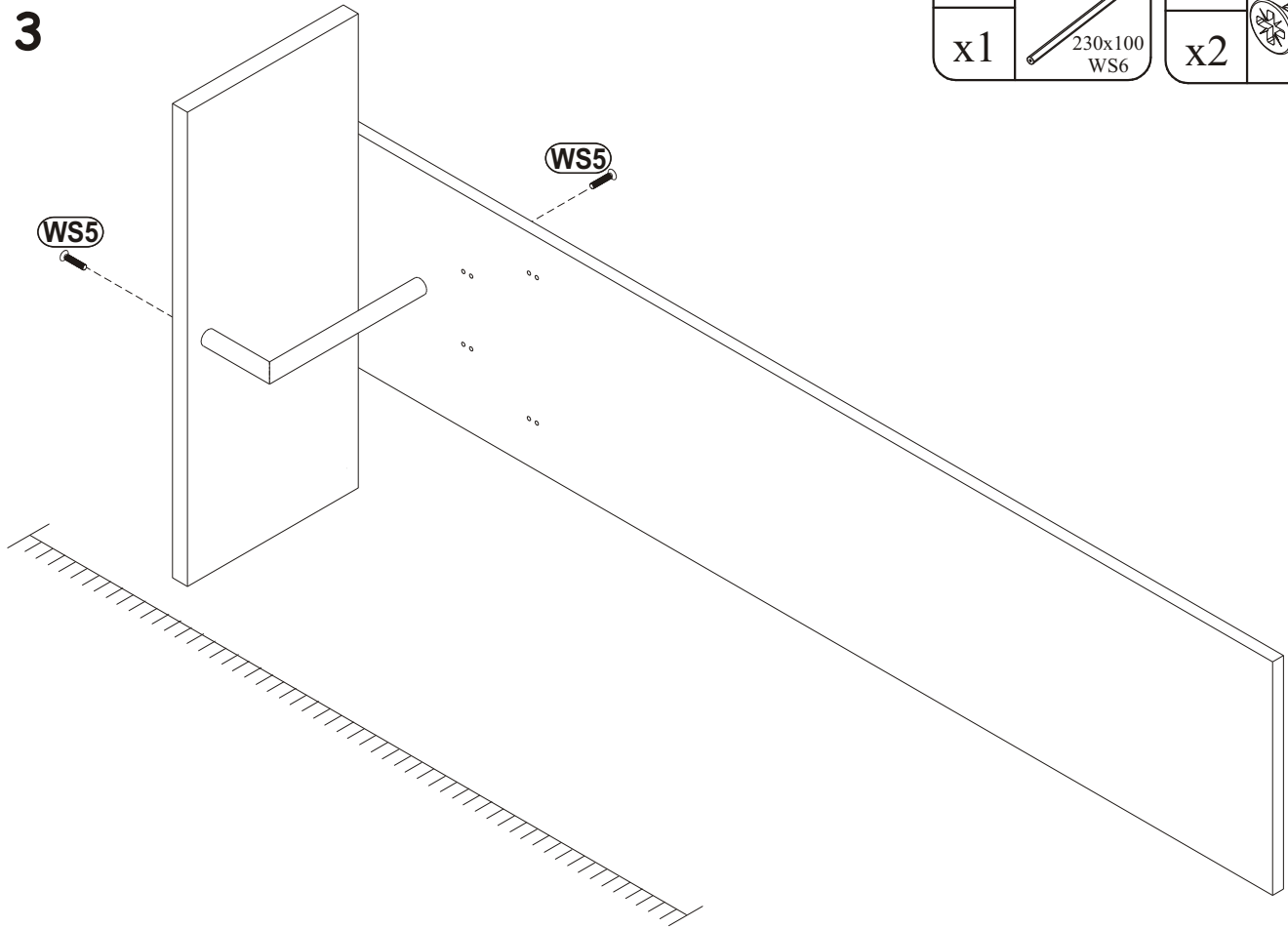
WL3		WS5	
x1	230x100 WS6	x2	WS6x30

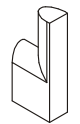

4

WS1		UP6	
x4		x8	UPØ4x30

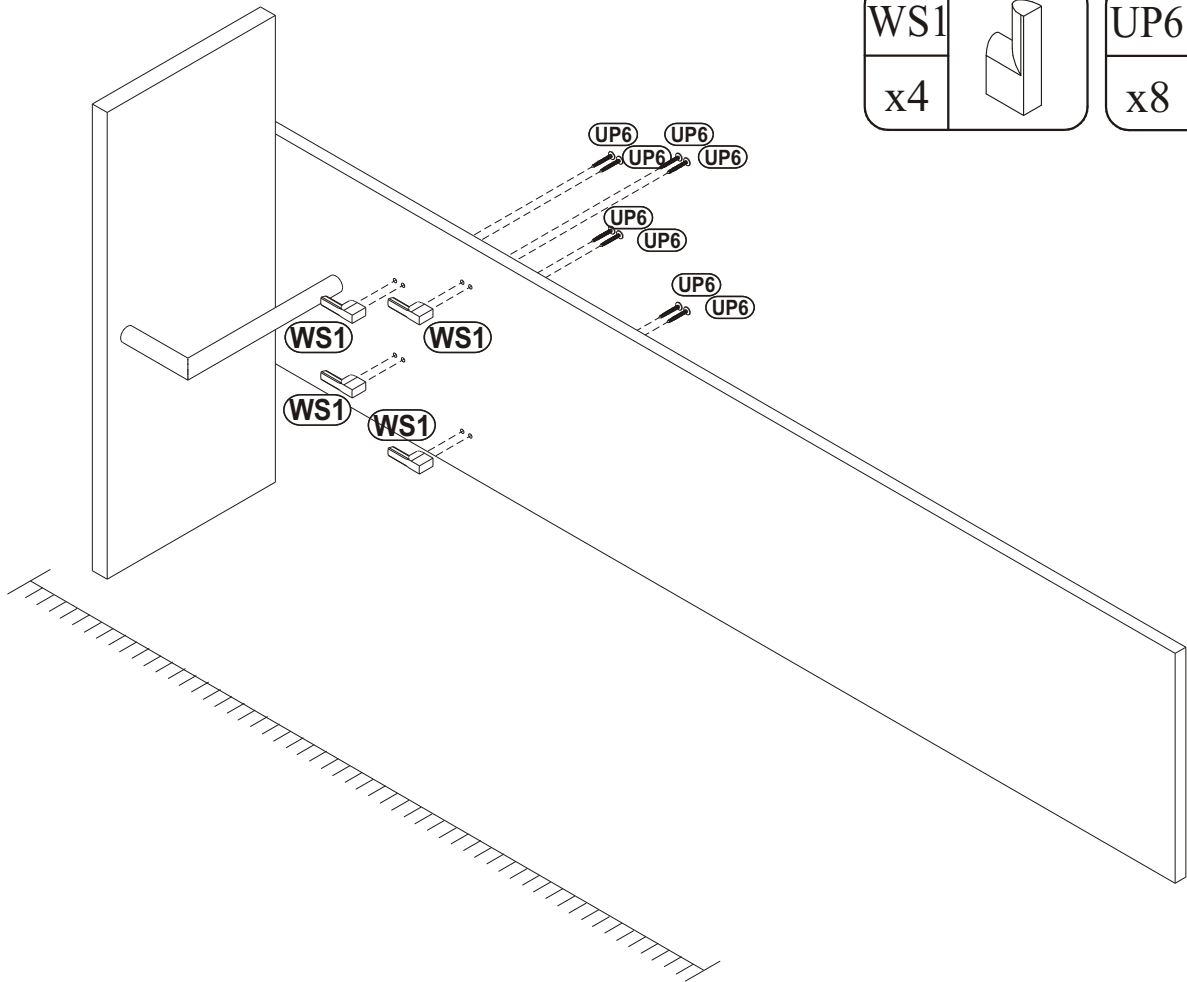

5

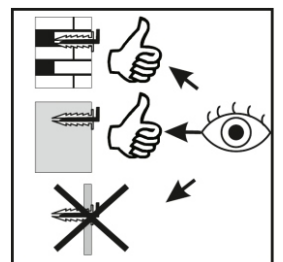
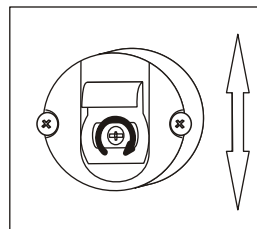
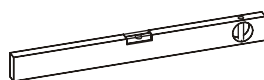
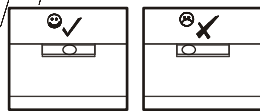
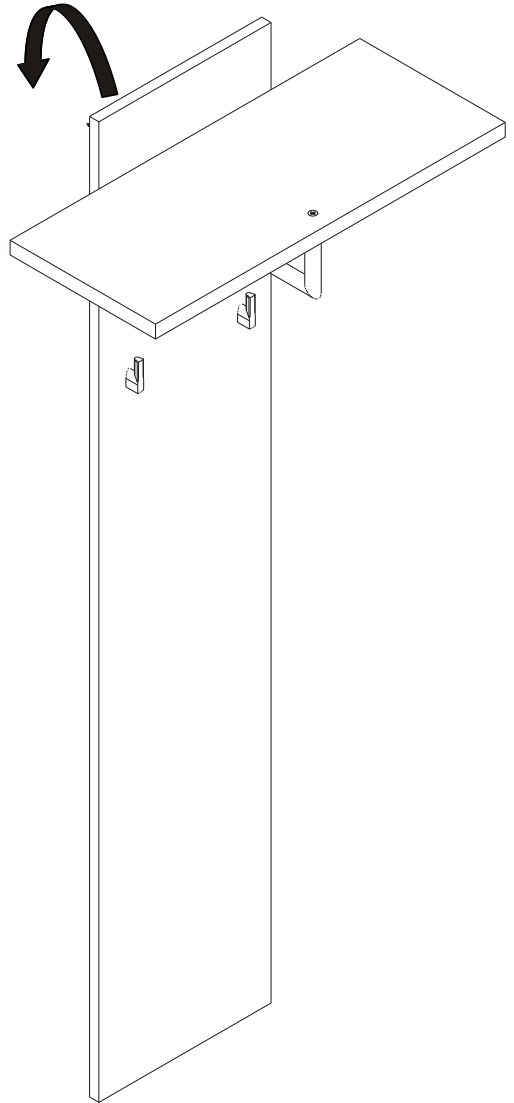
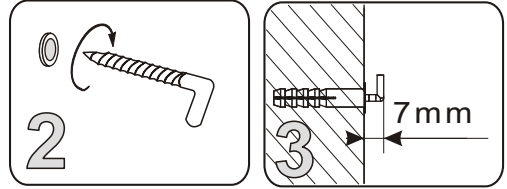
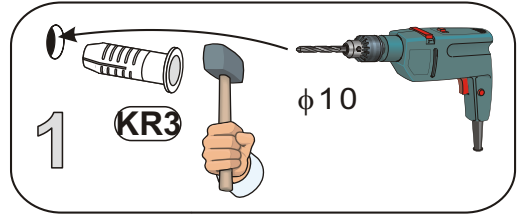
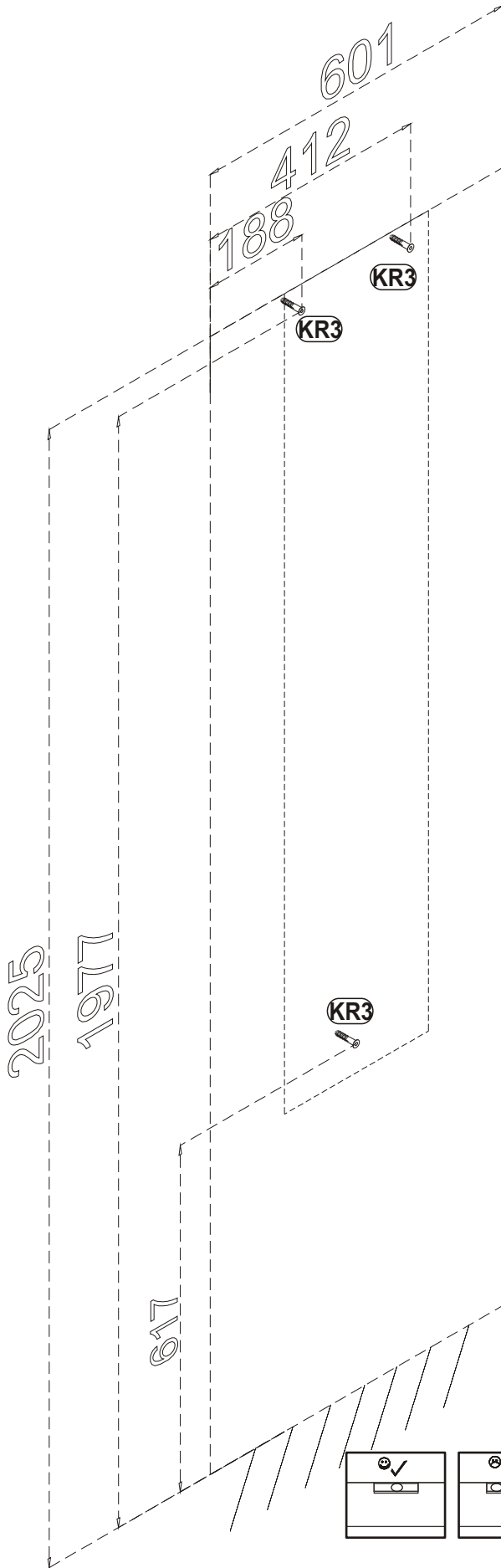
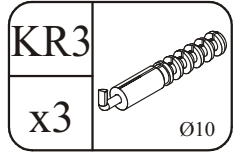

PEDRO HJZ PD ___ TYP F

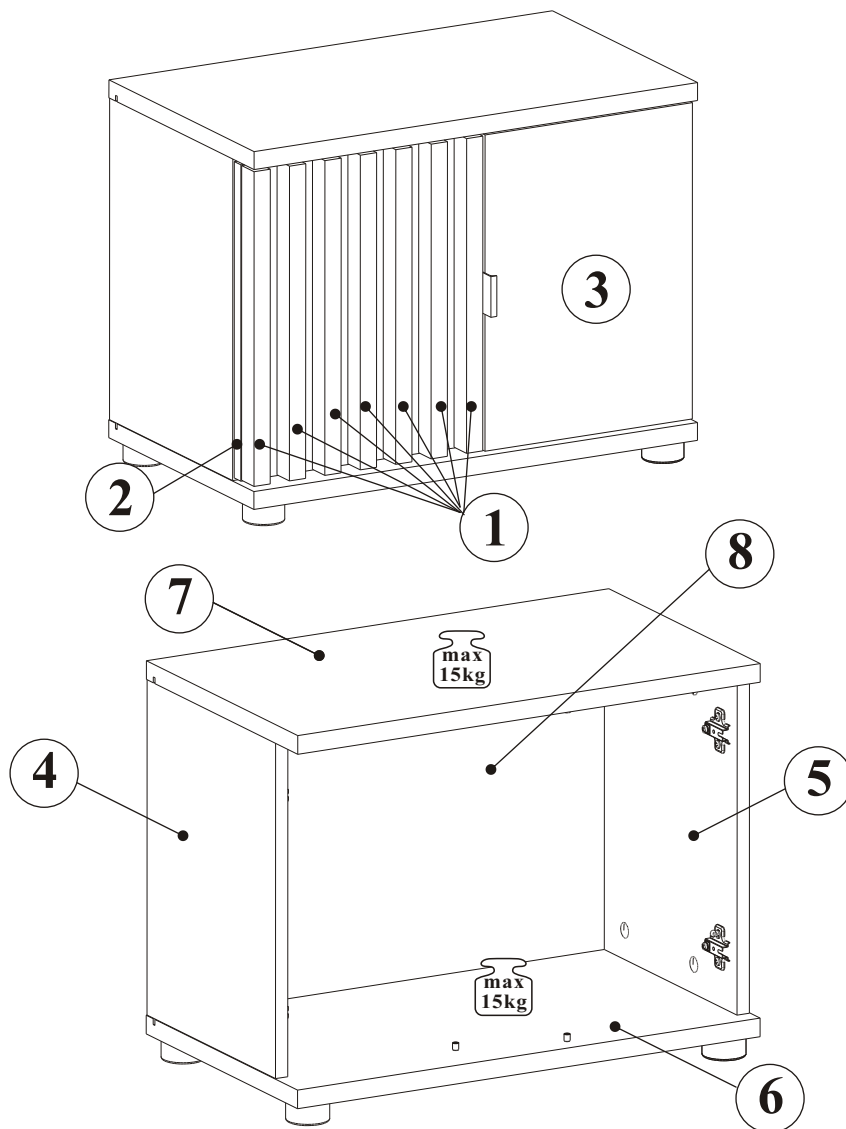
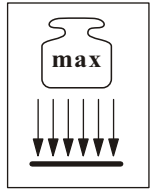

NO	DIM [mm]		COL.-NO	QTY
1	387	30	22 1/1	7
2	312	389	16 1/1	1
3	281	389	16 1/1	1
4	396	297	16 1/1	1
5	396	327	16 1/1	1
6	601	350	22 1/1	1
7	601	350	22 1/1	1
8	408	579	3 1/1	1

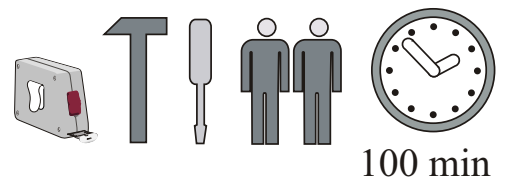



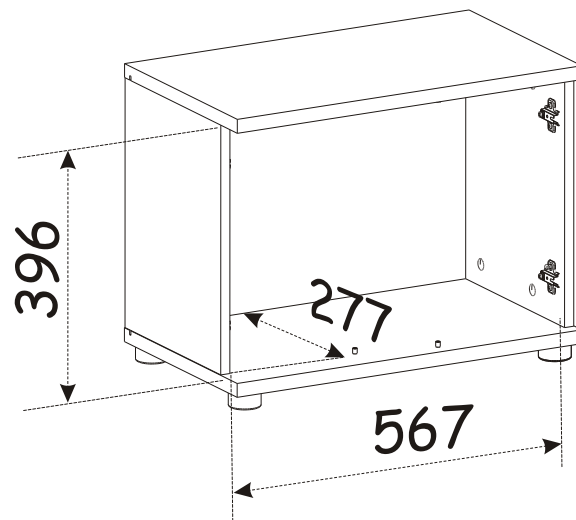
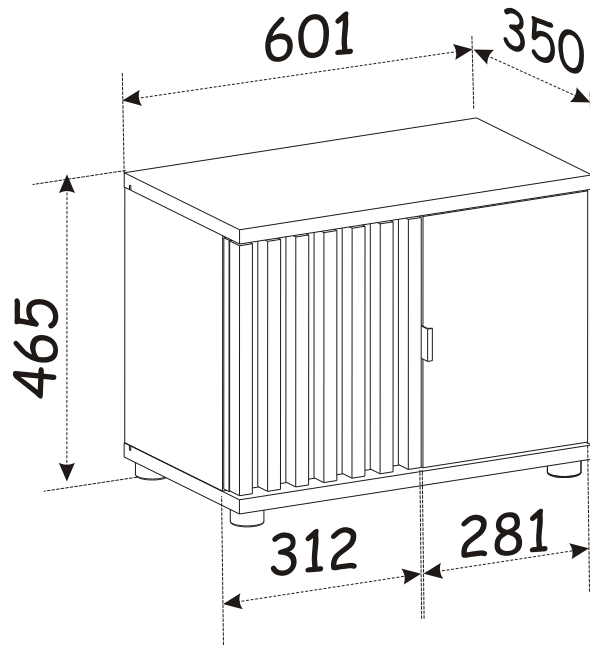

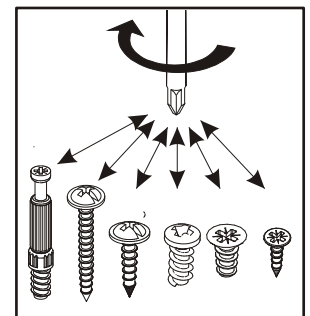
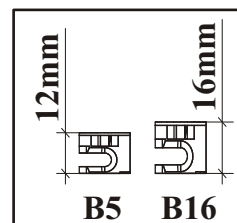
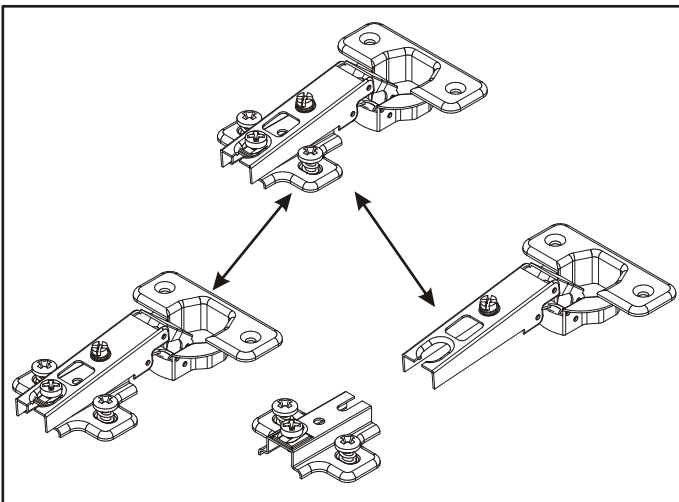
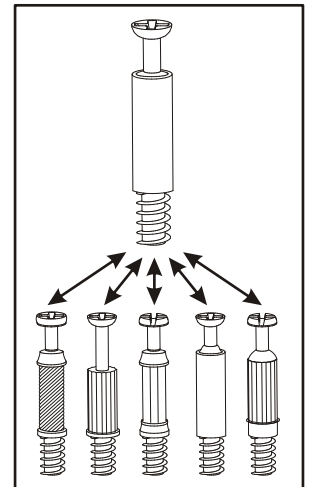
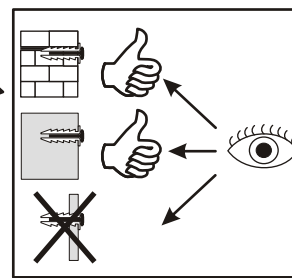
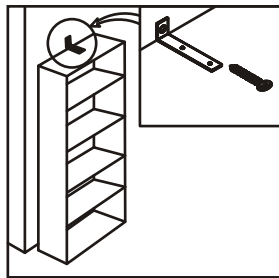
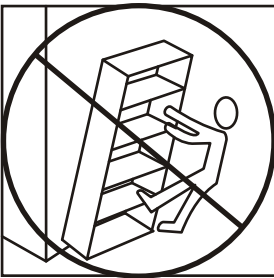
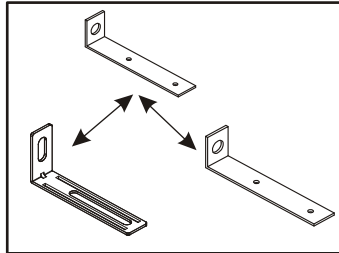
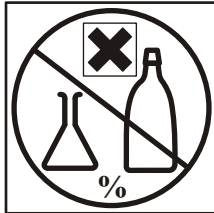
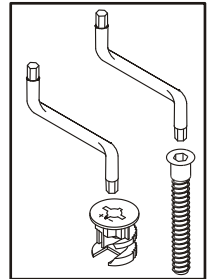
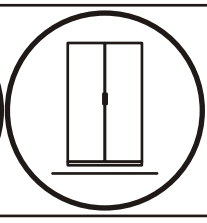
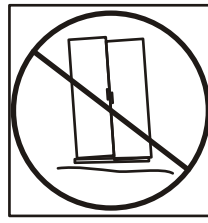
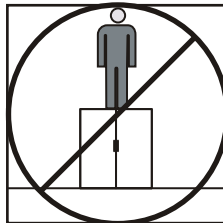
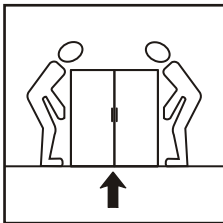
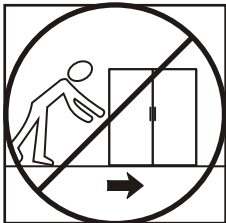
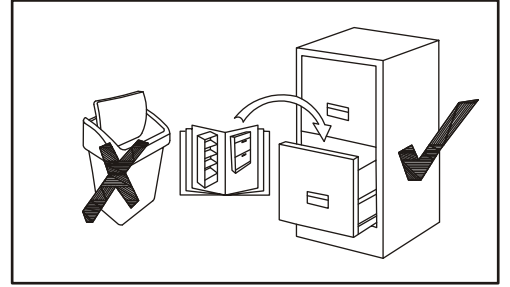
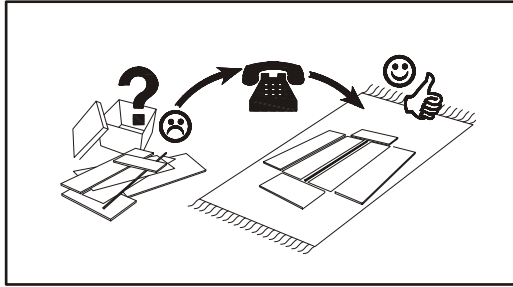
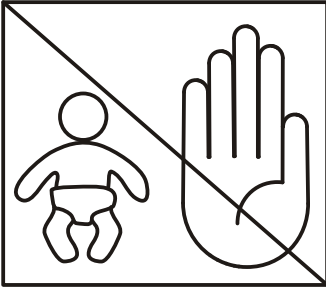
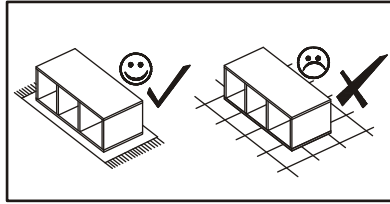
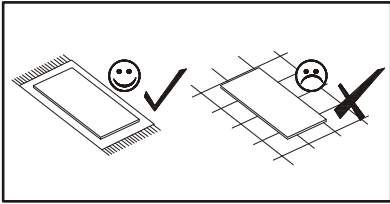

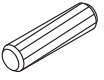

PEDRO HJZ PD _ TYP F

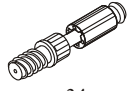

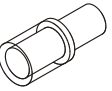
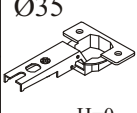
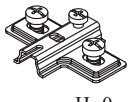
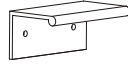
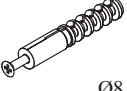
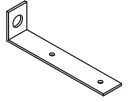
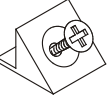
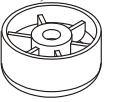

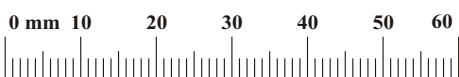

PEDRO HJZ PD _ TYP F

A1 x8  ø8x36	B22 x21  Ø7x40	G4 x18 	B4 x8  34	B5 x8  ø15x12	G5 x8 
G20 x4 	E21 x4  Ø35 H=0	E2 x4  H=0	G02 x1  L-32mm.	KR1 x2  Ø8	L1 x2 
S1 x6 	ST7 x4  Ø50, h=25	UP17 x4  UPØ4x25	D10 x14  USØ3,5x13	G2 x1 	G12 x3  Ø14

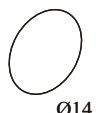

1

G12	
x3	Ø14

B22	
x21	Ø7x40

G4	
x18	

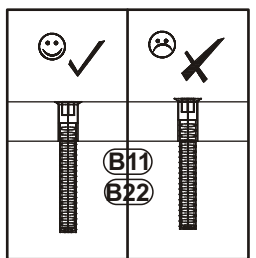
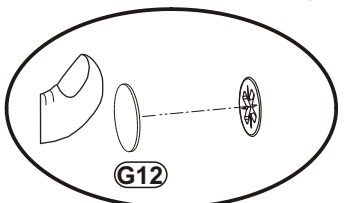
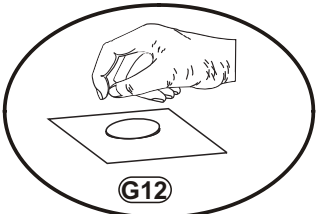
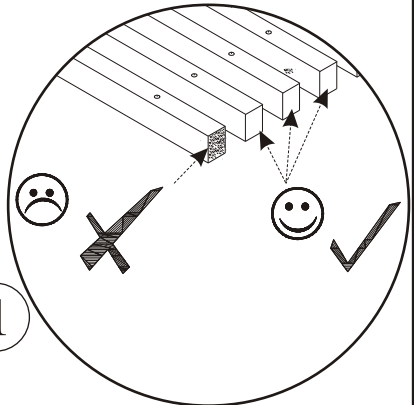
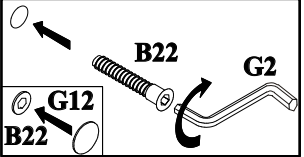
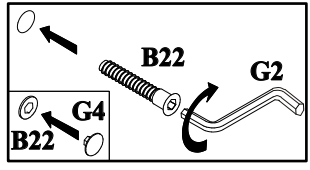
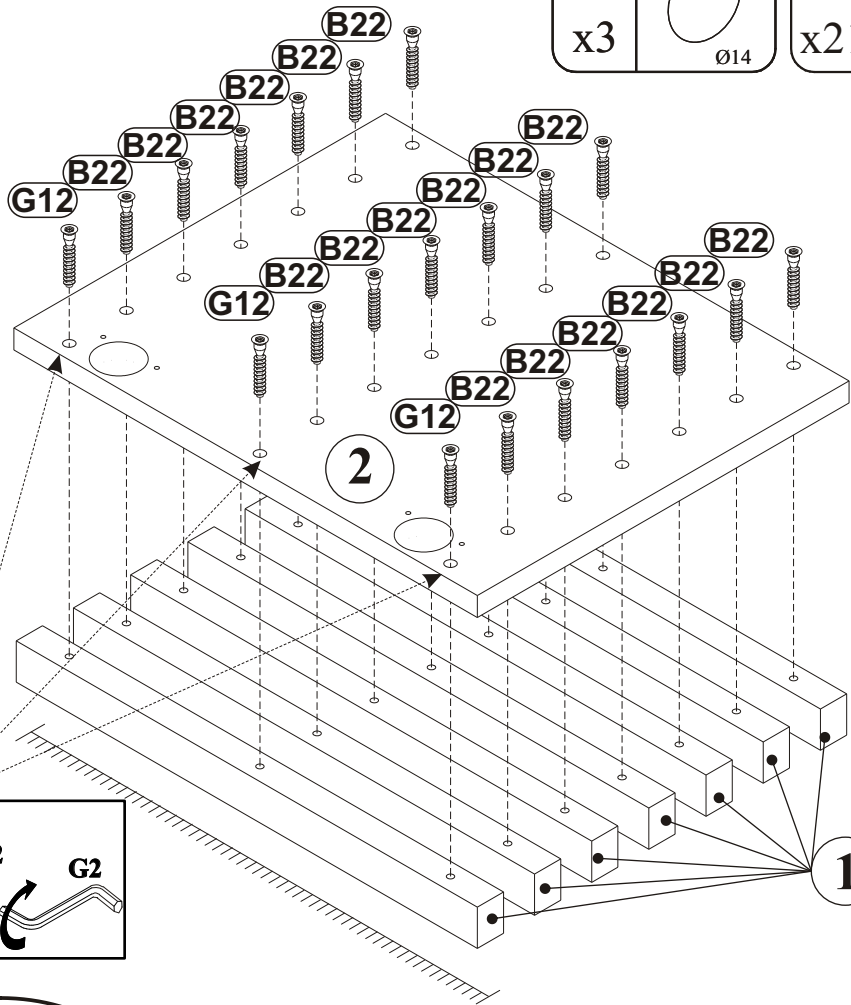

2

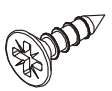
D10	
x4	USØ3,5x13

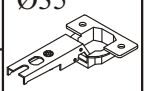
E21	Ø35 
x2	H=0

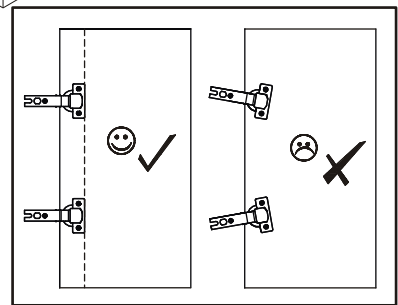
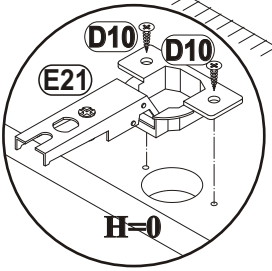
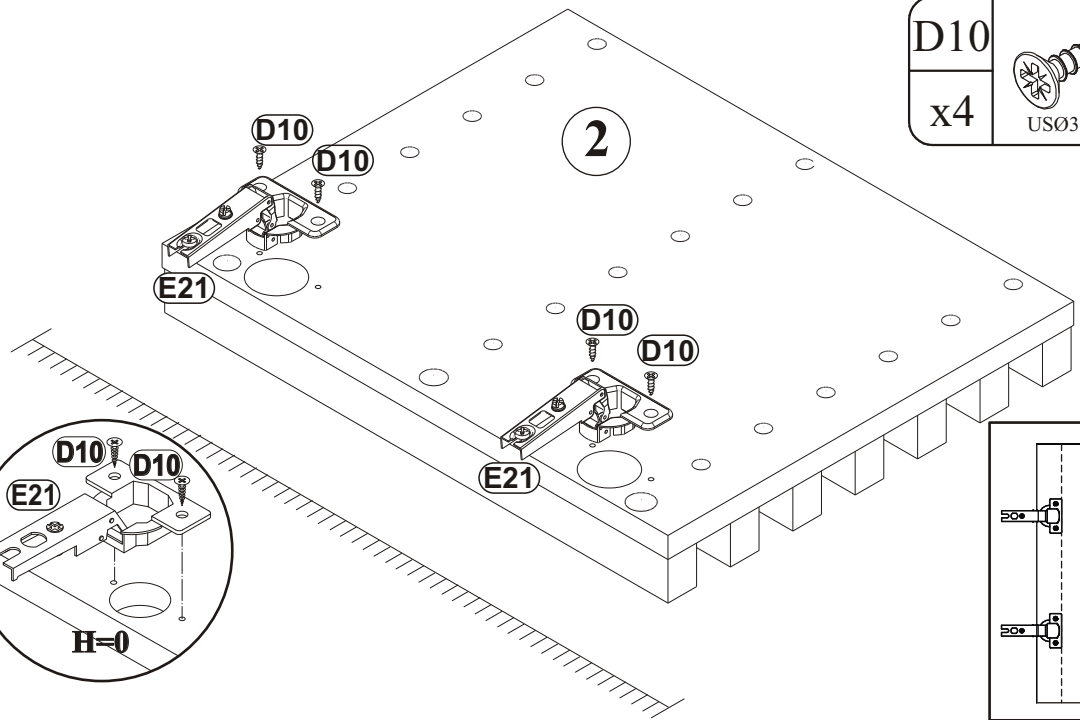

3

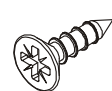
D10	
x6	USØ3,5x13

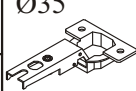
E21	Ø35 
x2	H=0

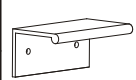
G02	
x1	L-32mm.

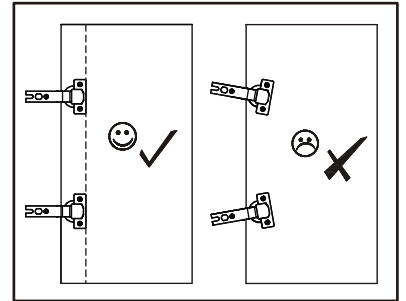
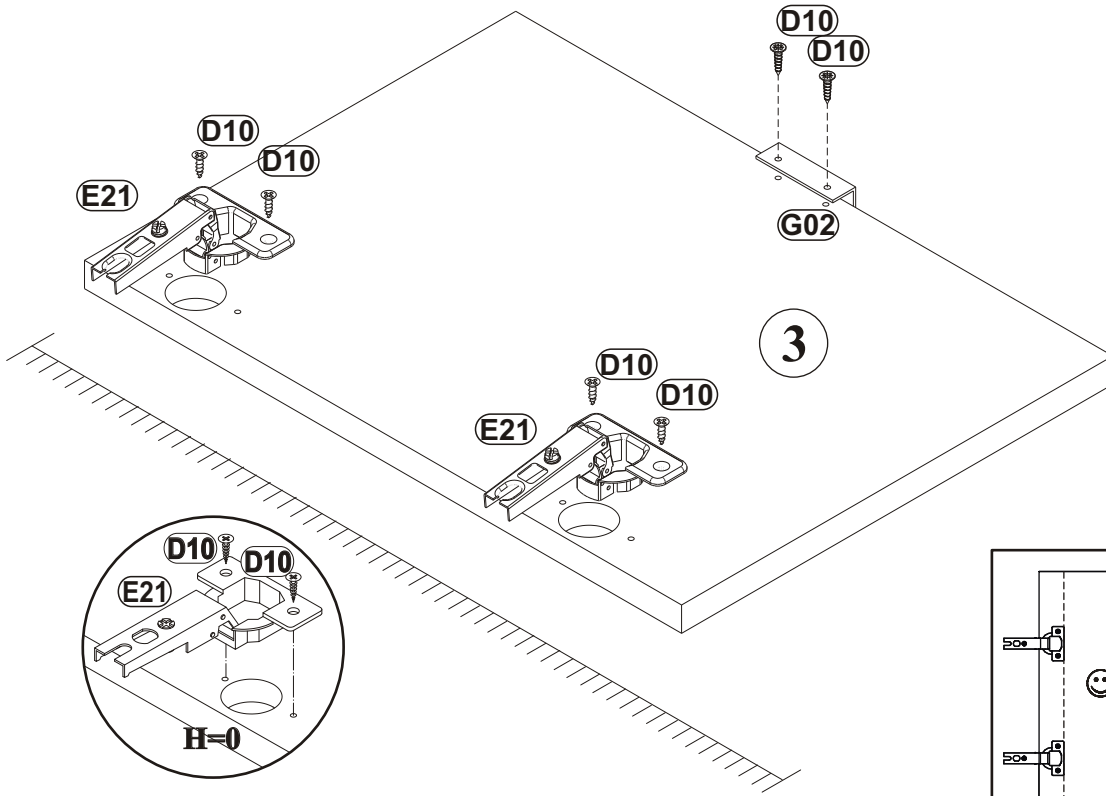

4

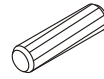
A1	
x4	ø8x36

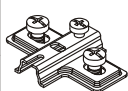
E2	
x2	H=0

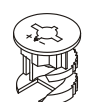
B5	
x4	ø15x12

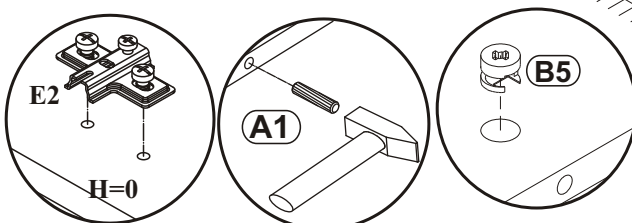
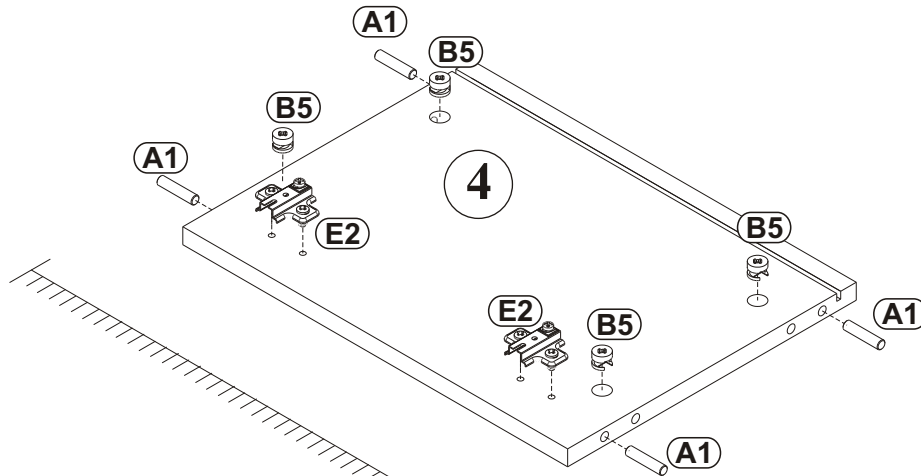

5

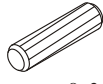
A1	
x4	ø8x36

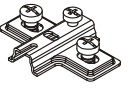
E2	
x2	H=0

B5	
x4	ø15x12

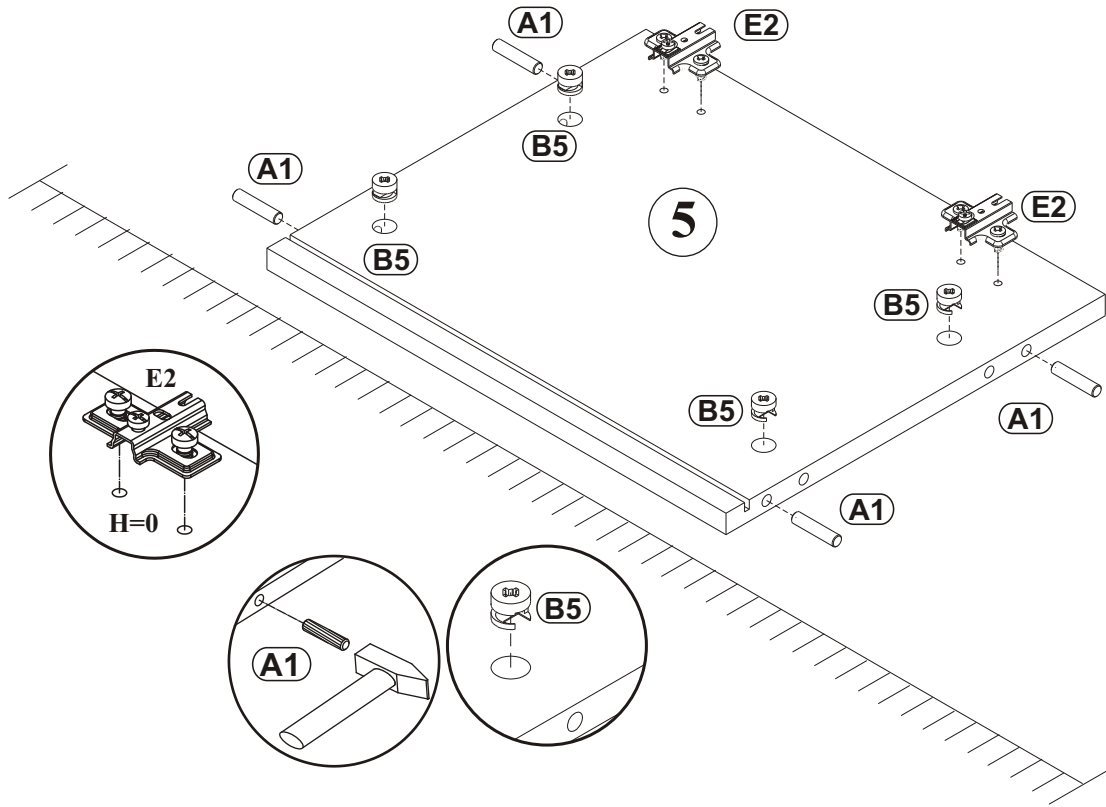

6

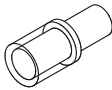
G20	
x2	

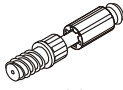
B4	
x4	34

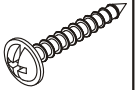
UP17	
x4	UPØ4x25

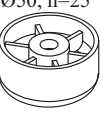
ST7	Ø50, h=25
x4	

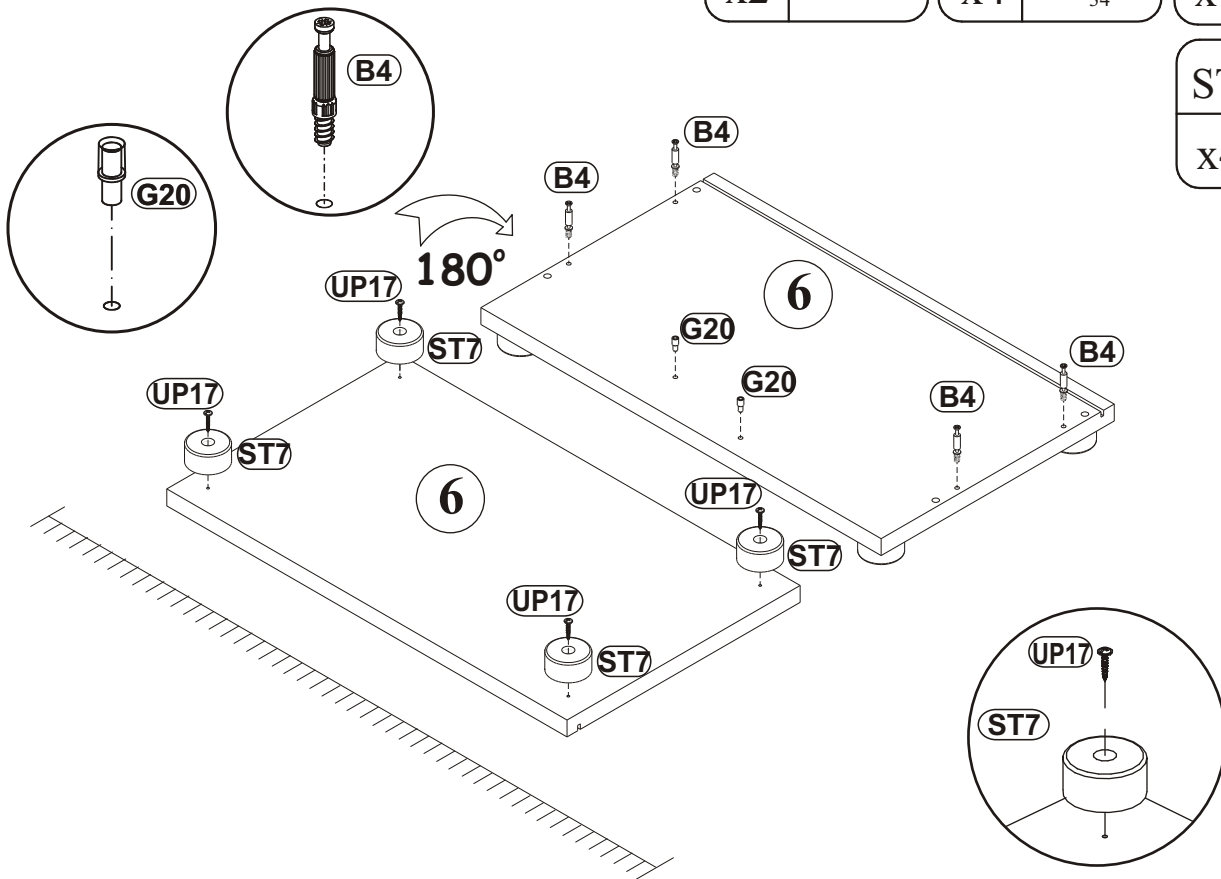

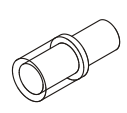
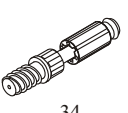
G20		B4	
x2		x4	34

7

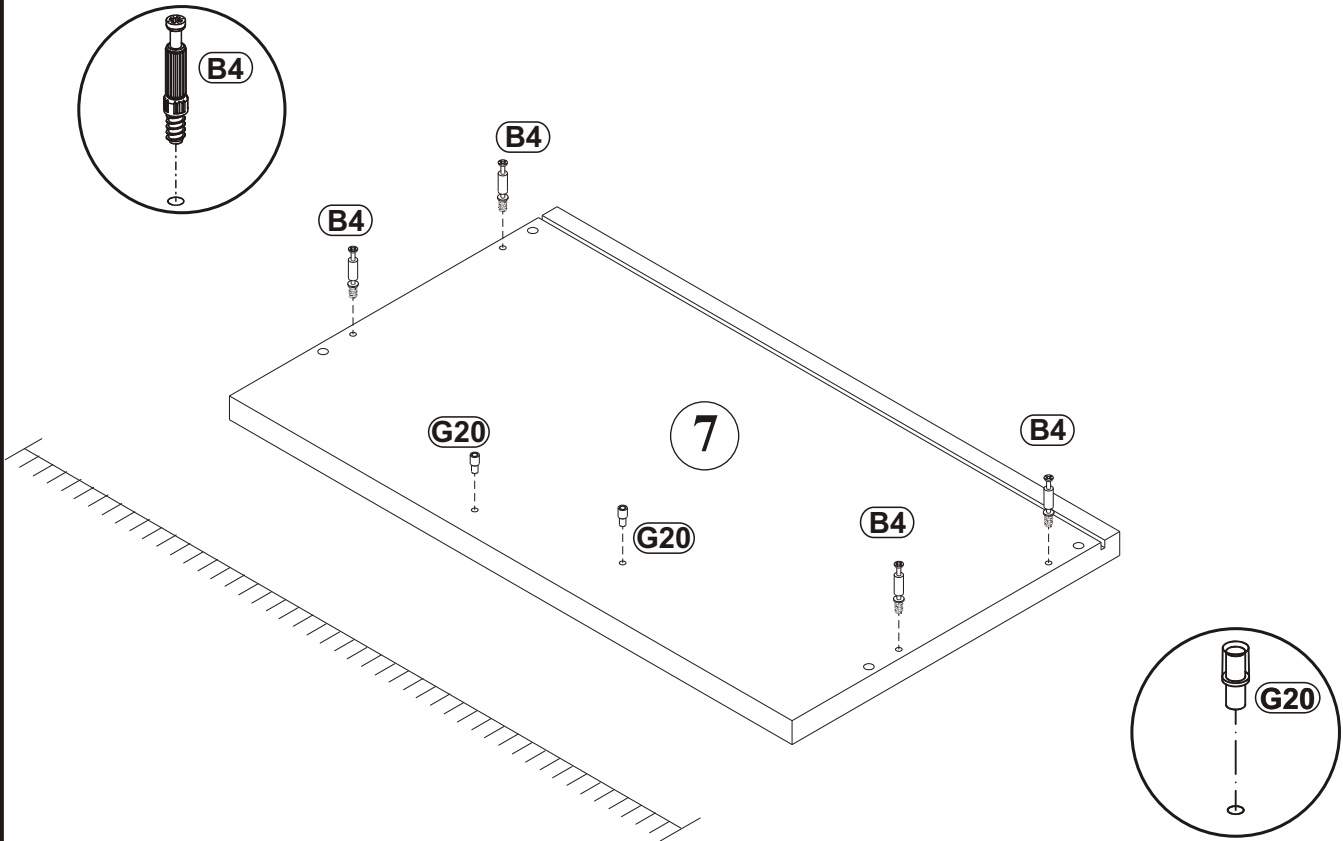

8

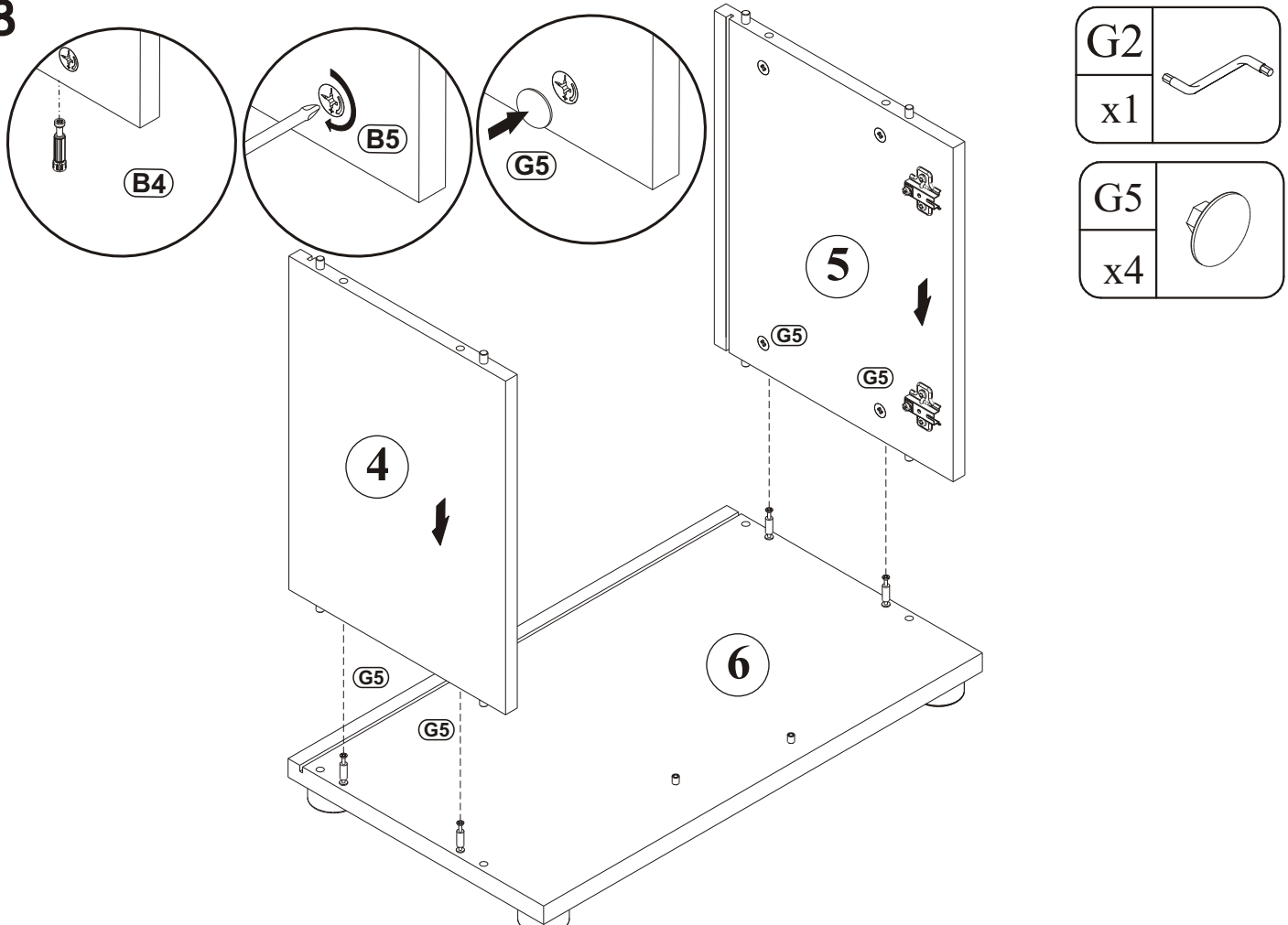

9

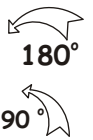
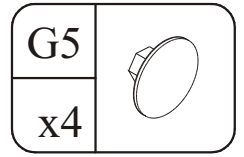
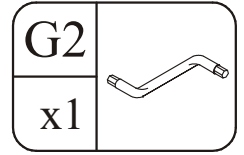
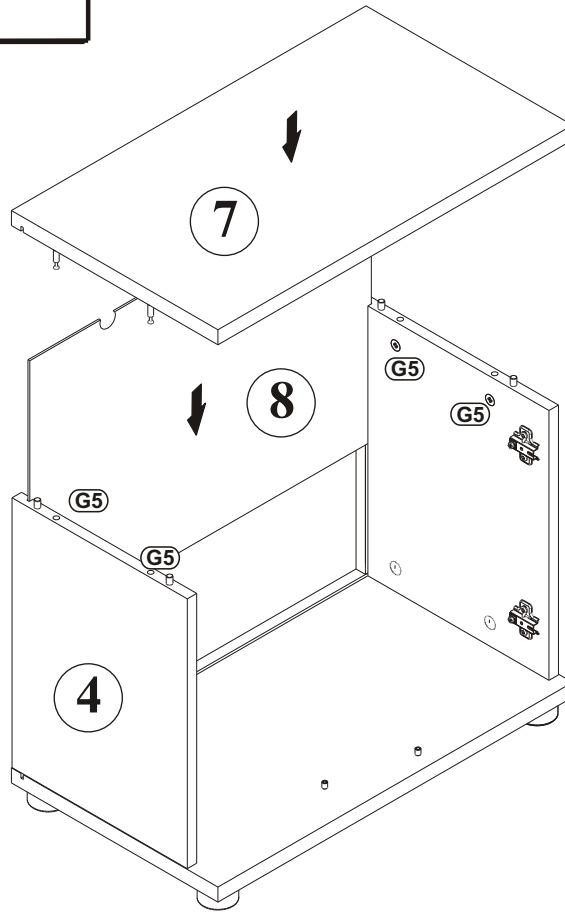
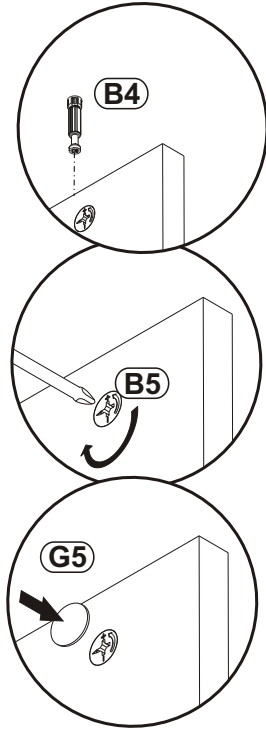

10

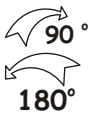
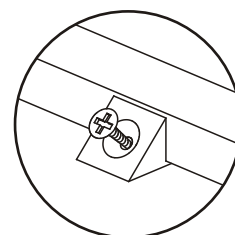
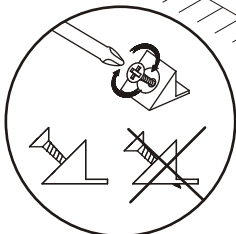
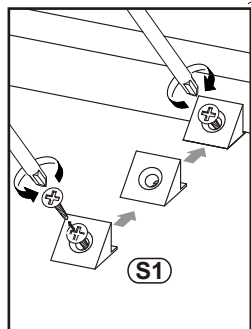
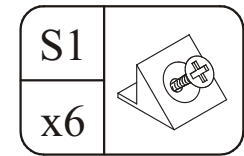
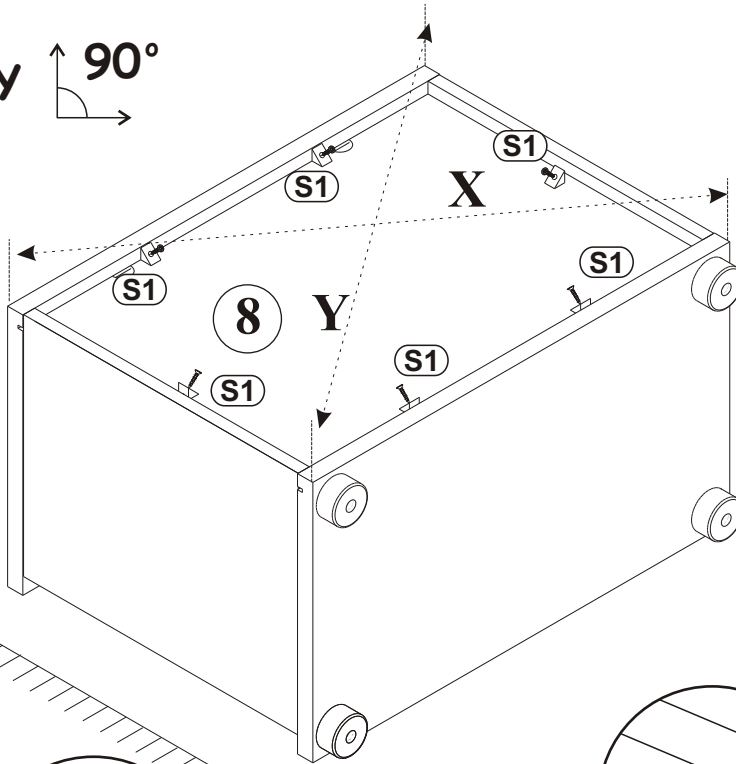

11

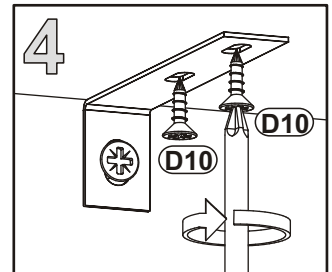
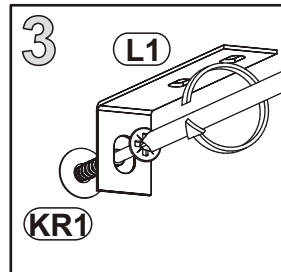
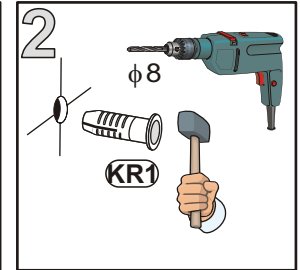
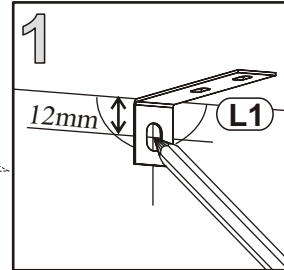
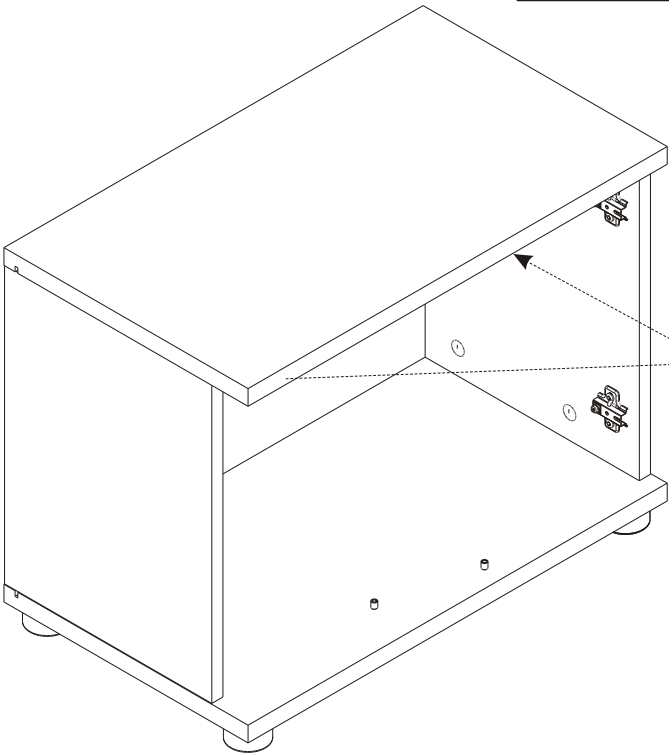
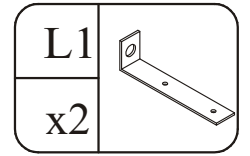
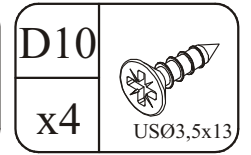
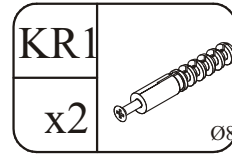
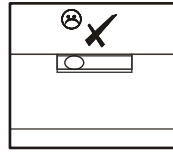
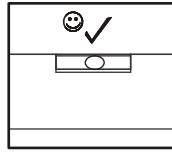

12

