

CAMERON ___ CM WSW

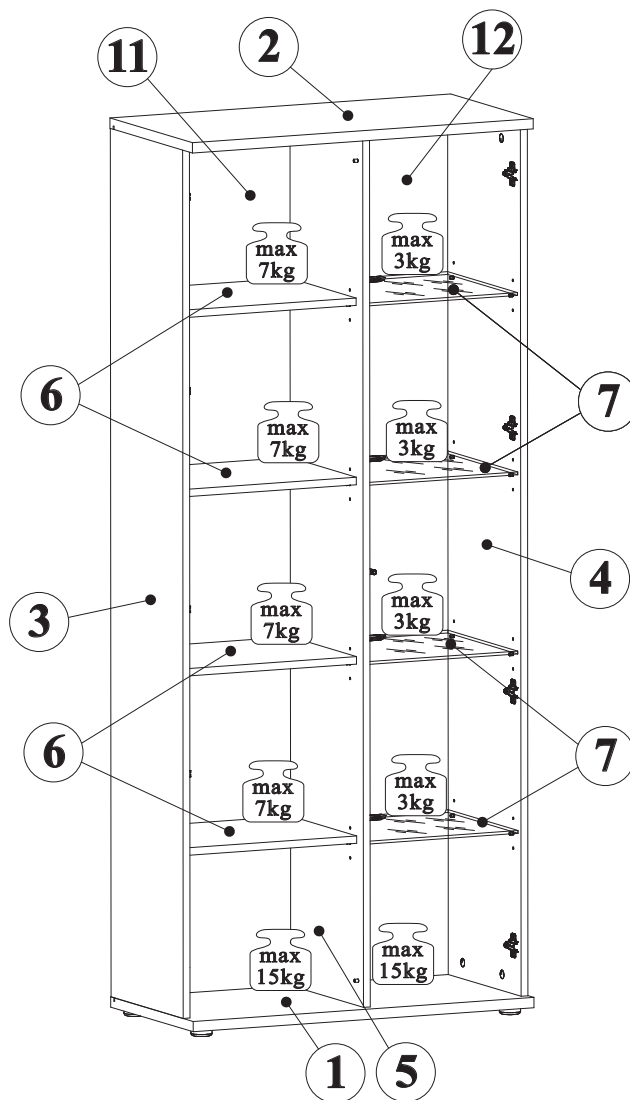

NO	Dim (mm)			Col.-No	Qty
1	802	402	22	1/3	1
2	802	402	22	1/3	1
3	1860	352	16	2/3	1
4	1860	375	16	2/3	1
5	1860	355	16	2/3	1
6	397	322	16	1/3	4
7	354	340	6	1/3	4
8	1852	408	16	3/3	1
9	1852	385	16	3/3	1
11	1872	411	3	3/3	1
12	1872	369	3	3/3	1
13	1851	30	22	3/3	9

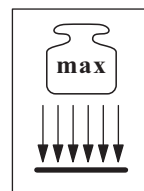
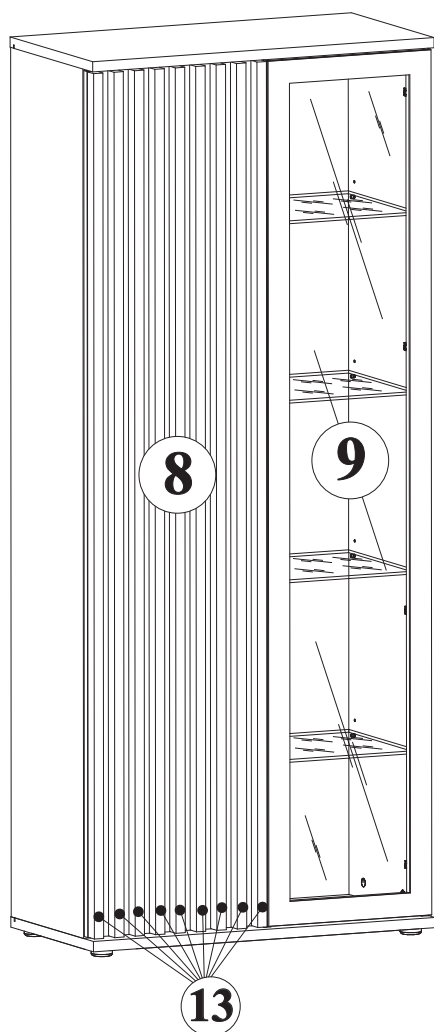
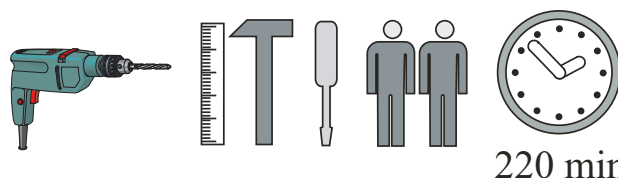

220 min

CAMERON ___ CM WSW

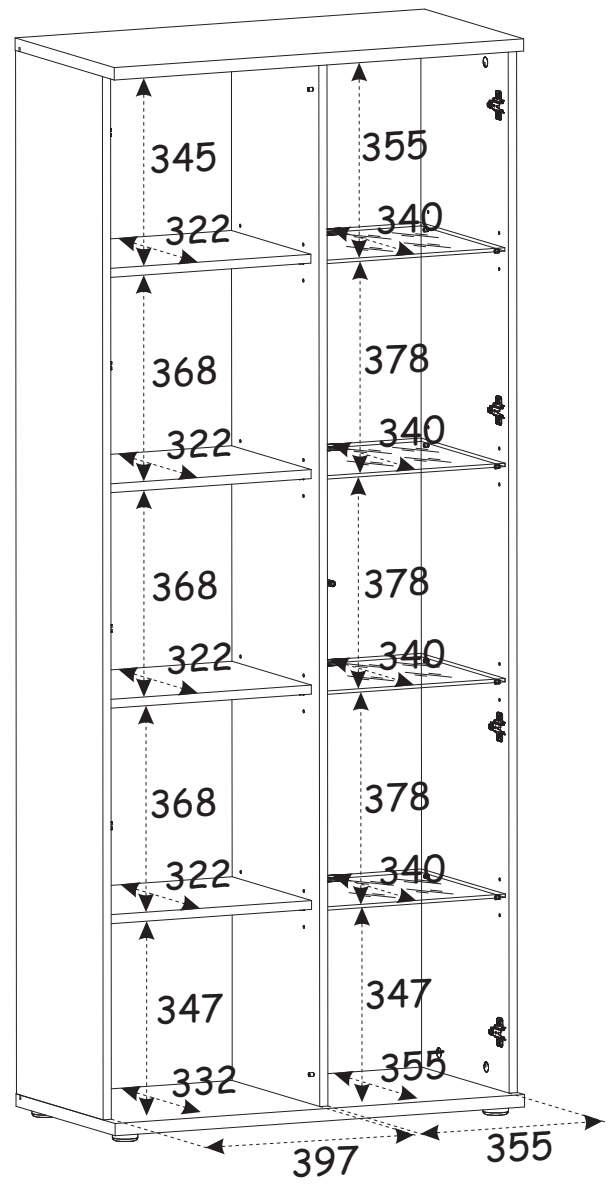
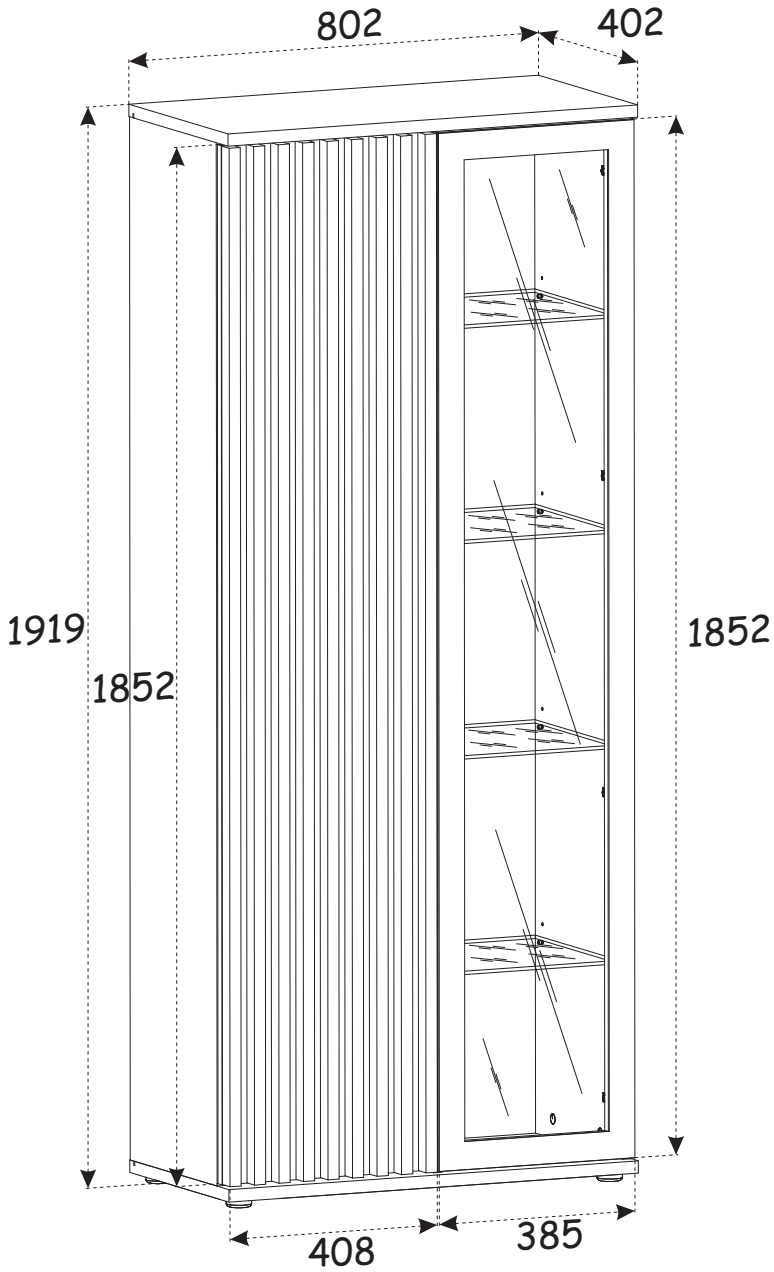

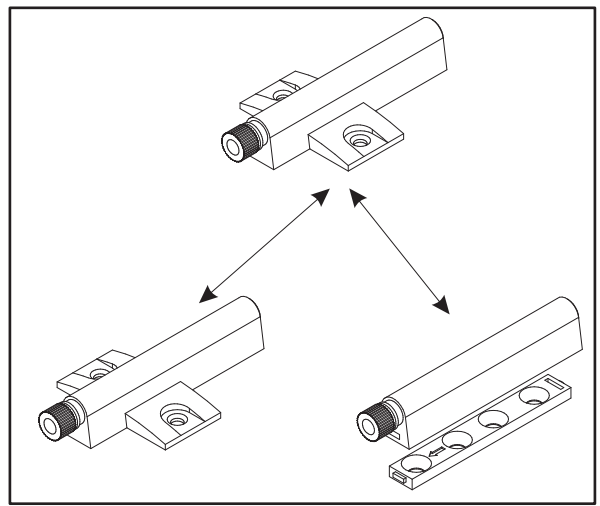
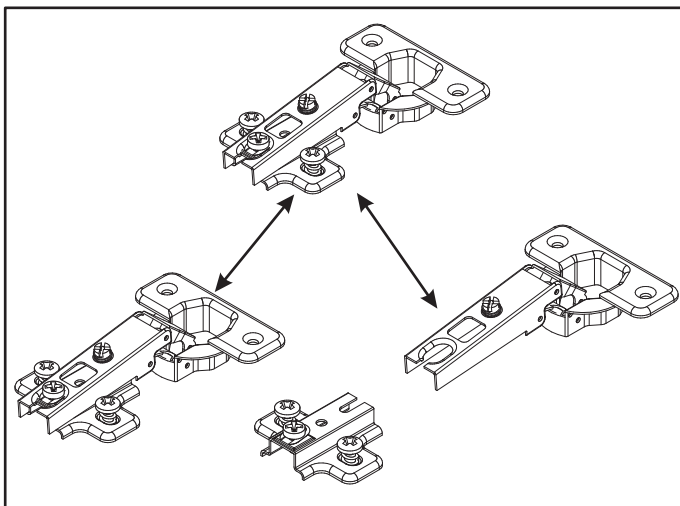
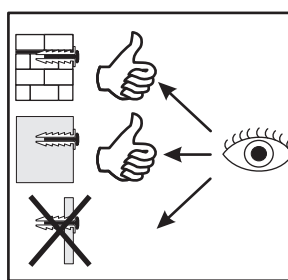
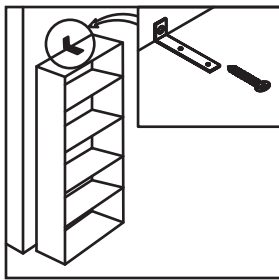
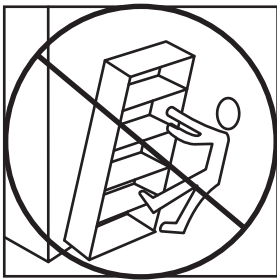
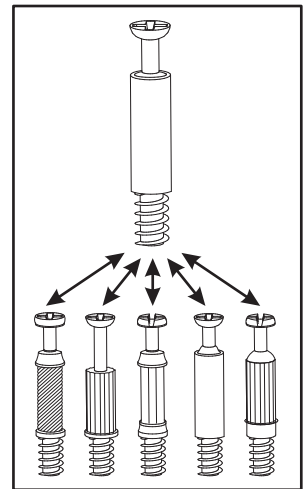
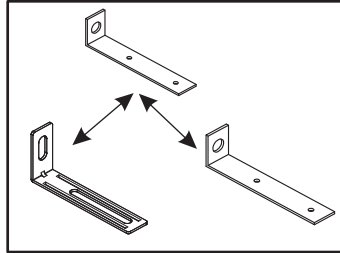
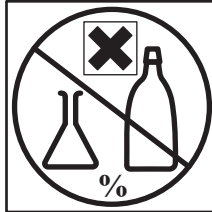
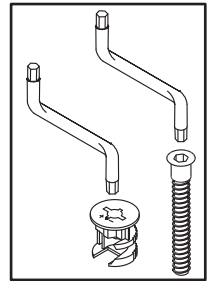
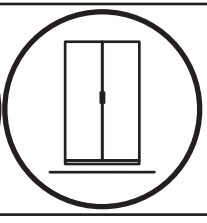
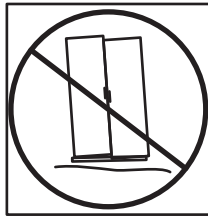
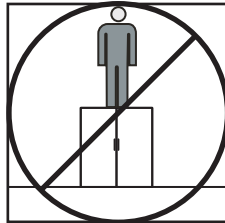
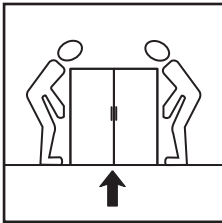
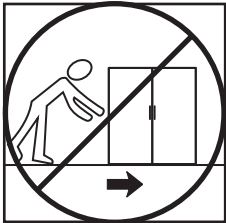
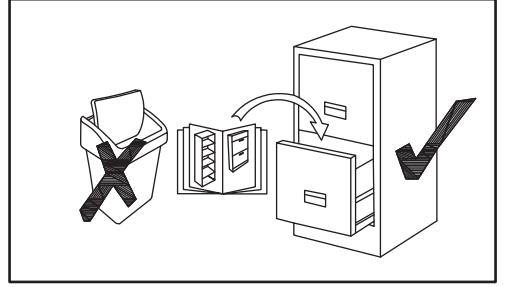
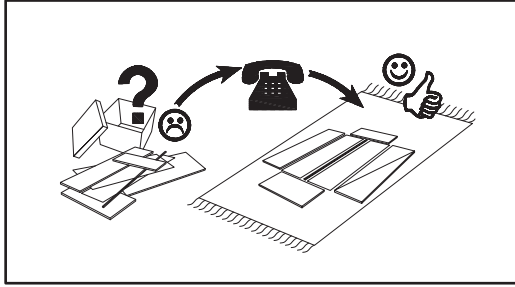
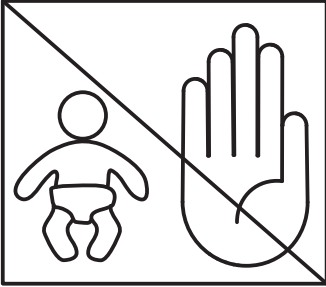
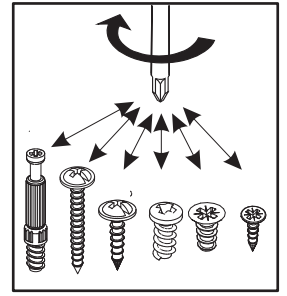
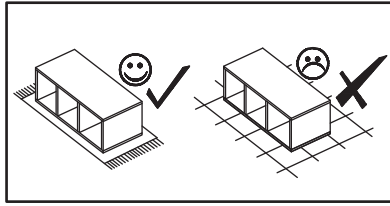
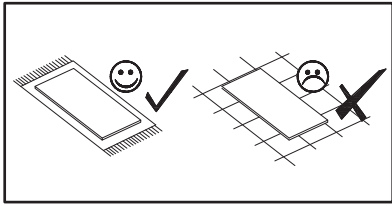

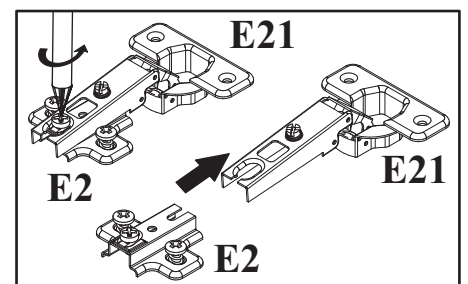
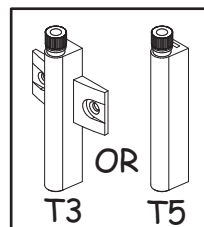
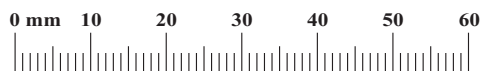

CAMERON ___ CM WSW

A1 x12 ø8x36		B22 x45 Ø7x40		G4 x40		B4 x12		B5 x12 Ø15x12		G5 x12	
E21 x9 Ø35 H=0		E2 x9 H=0		T3/T5 x1		LED x1 1x4		S1 x22		G16 x10	
G7 x16		G20 x18		I11 x5 Ø45, h=15		UP11 x5 UPØ4x20		D10 x22 USØ3,5x13		UP9 x10 UPØ3,5x16	
KR1 x1 Ø8		L1 x1		G2 x1		G12 x5 Ø14					



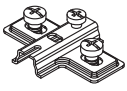
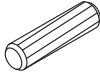
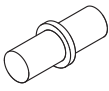

1

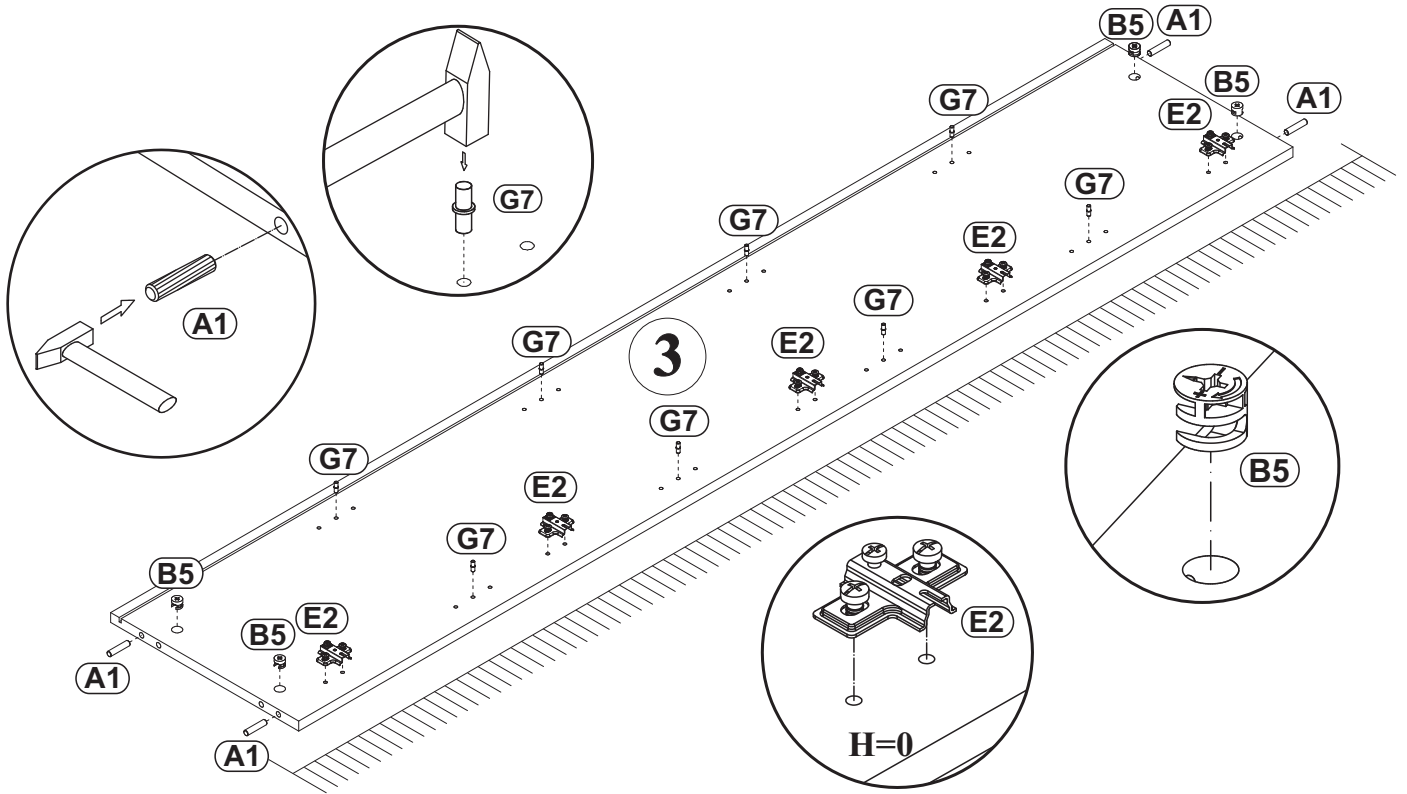
E2 x5	 H=0	A1 x4	 ø8x36	G7 x8		B5 x4	 Ø15x12
----------	--	----------	---	----------	---	----------	---

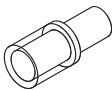
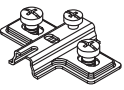
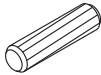

2

G20 x8		E2 x4	 H=0	A1 x4	 ø8x36	B5 x4	 Ø15x12
-----------	---	----------	---	----------	--	----------	---

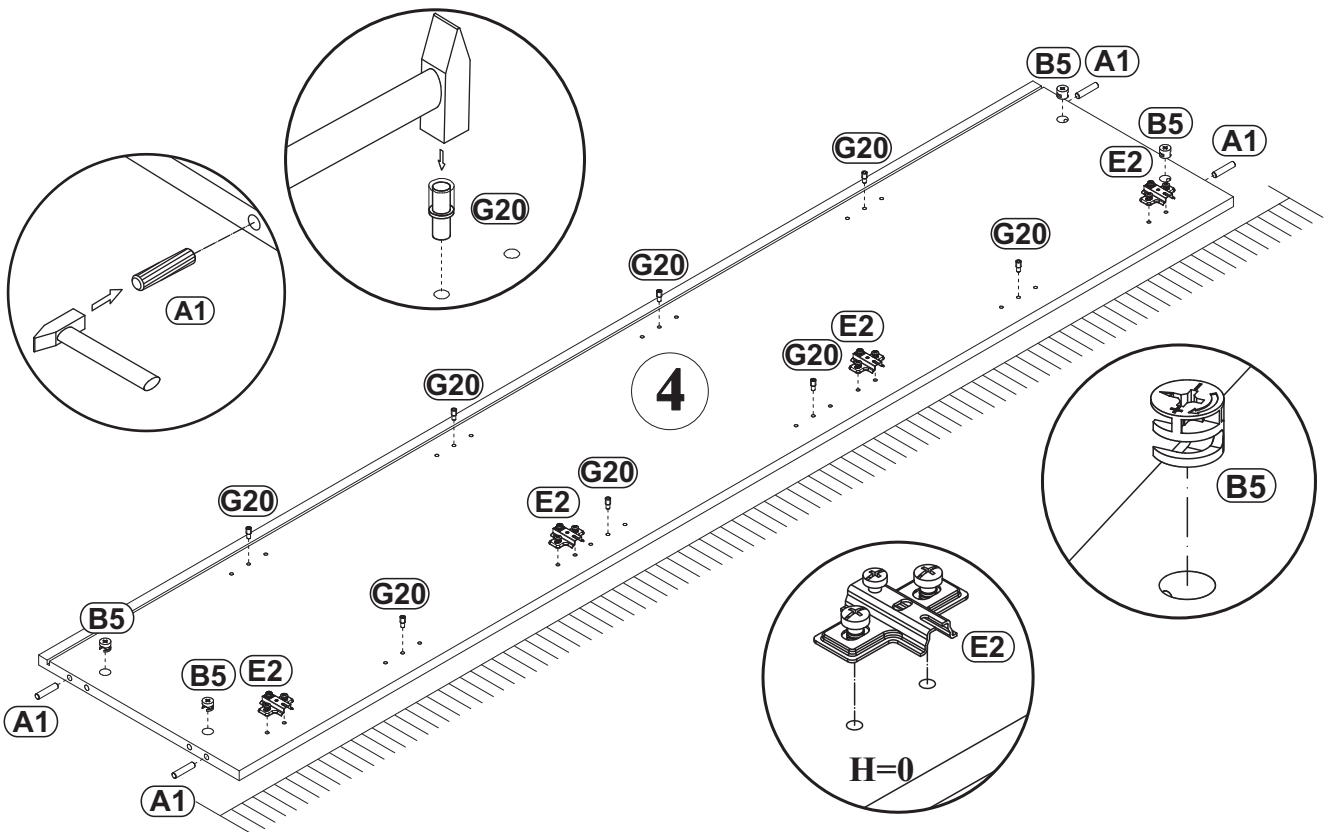

3

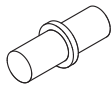
G7	
x8	

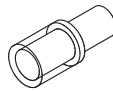
G20	
x10	

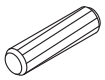
A1	
x4	ø8x36

B5	
x4	Ø15x12

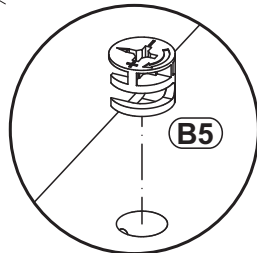
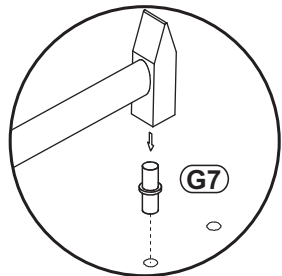
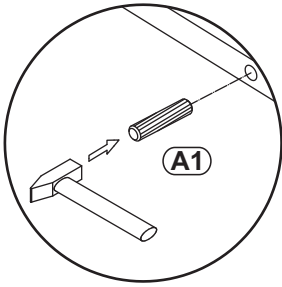
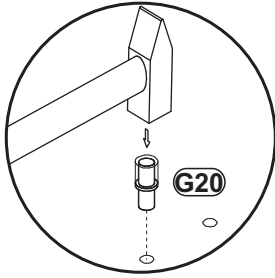
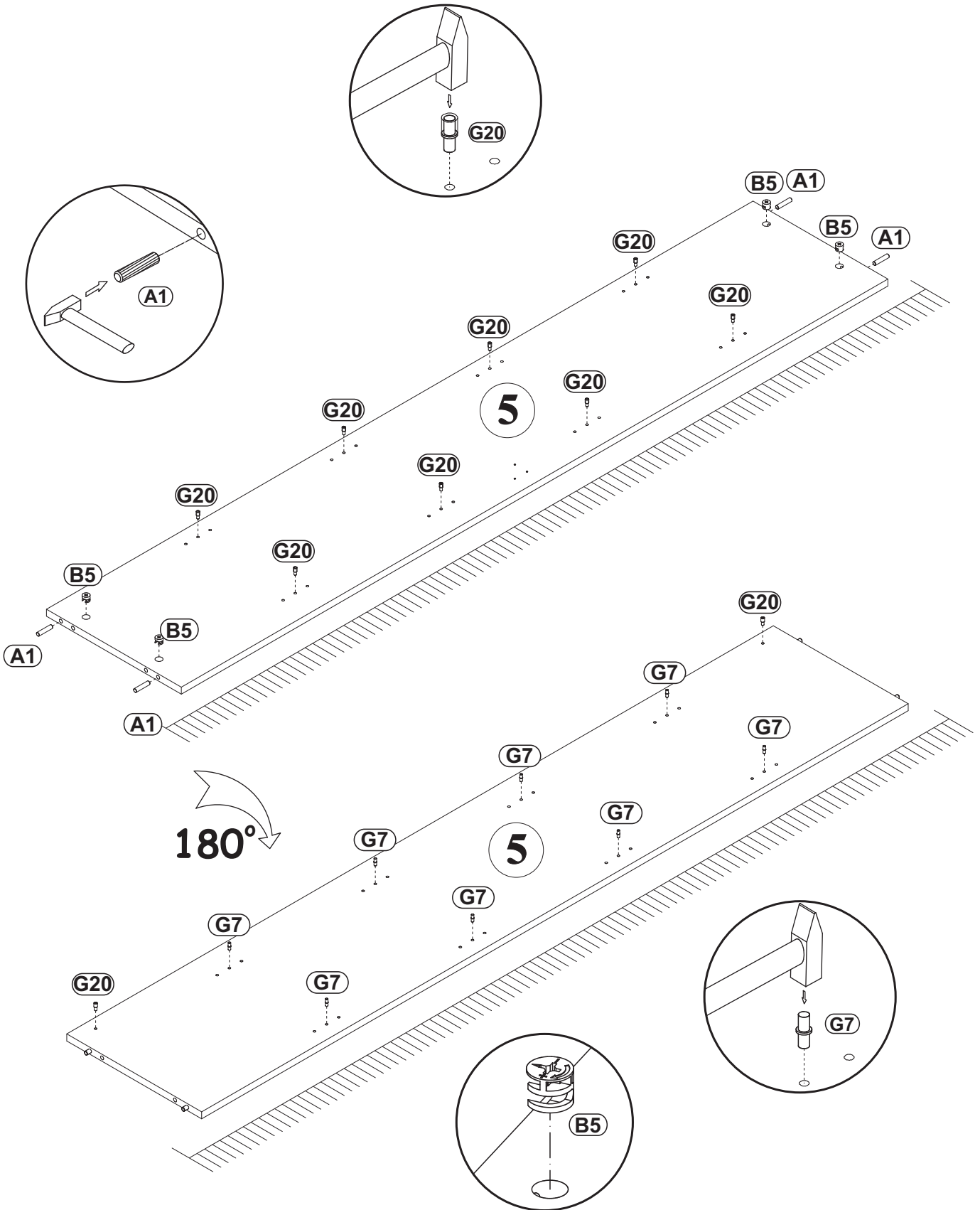

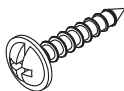
UP11	
x5	UPØ4x20

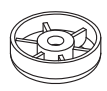
I11	
x5	Ø45, h=15

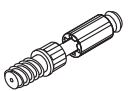
B4	
x6	

4

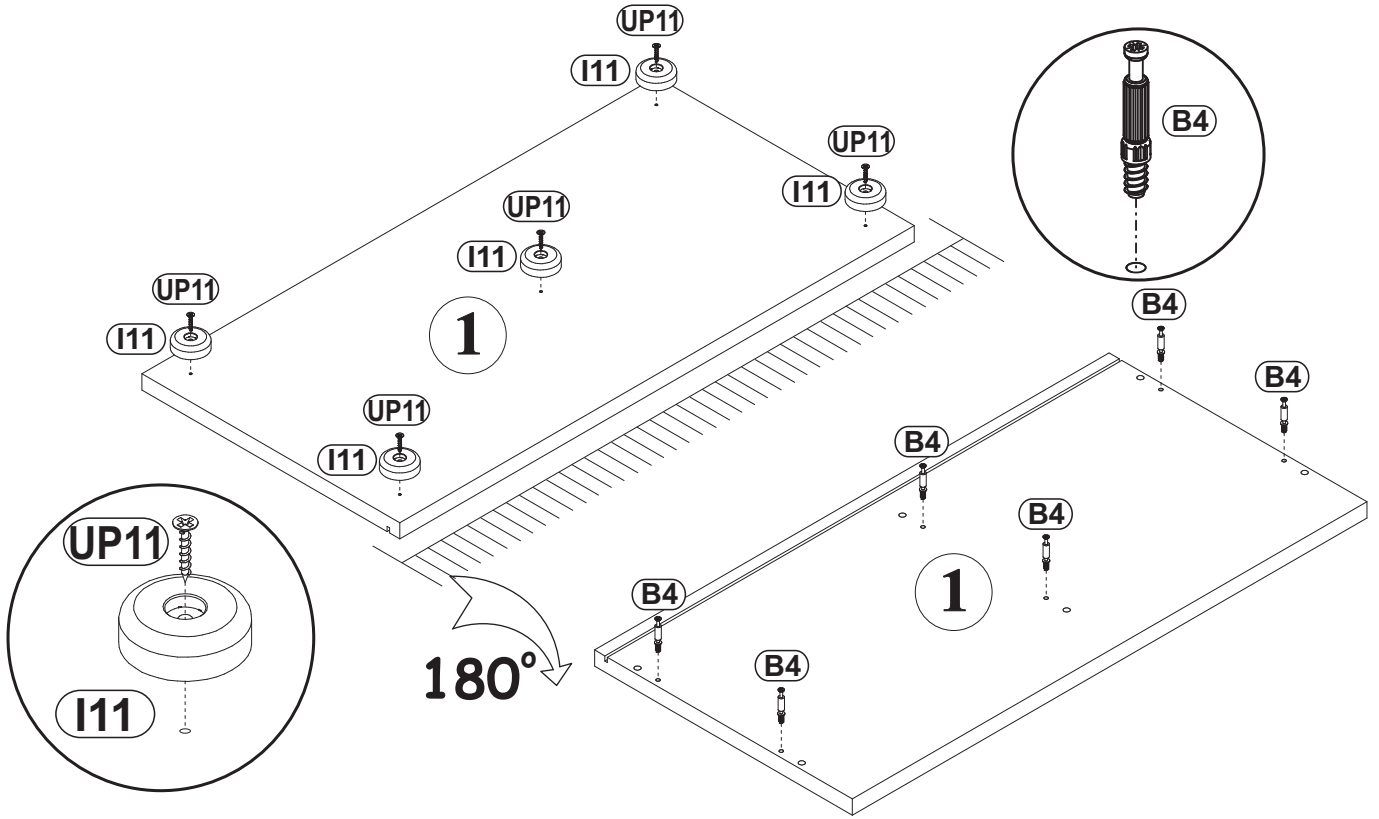

5

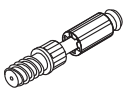
B4	
x6	

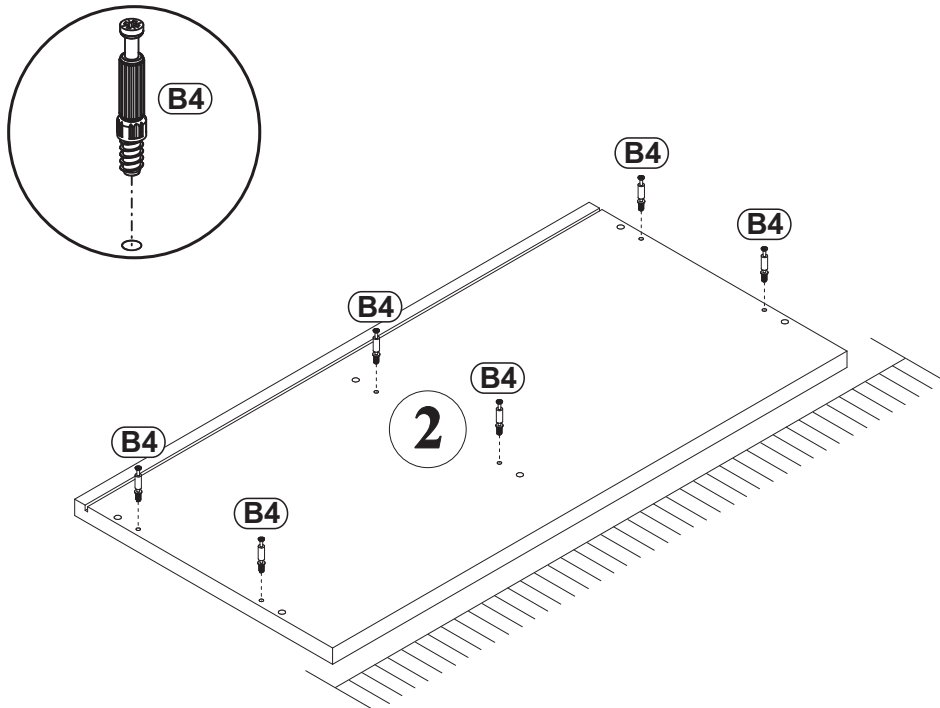

6

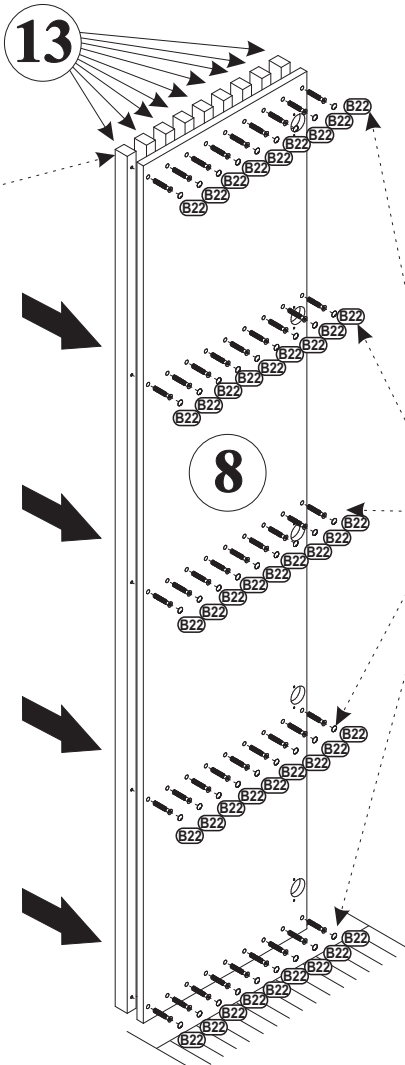
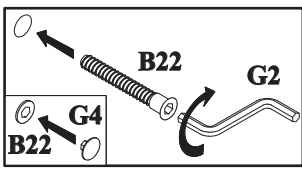
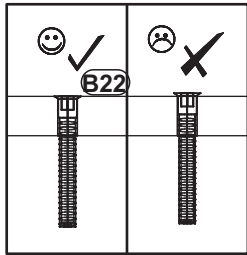
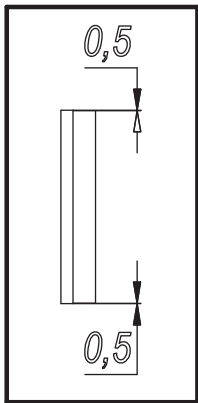
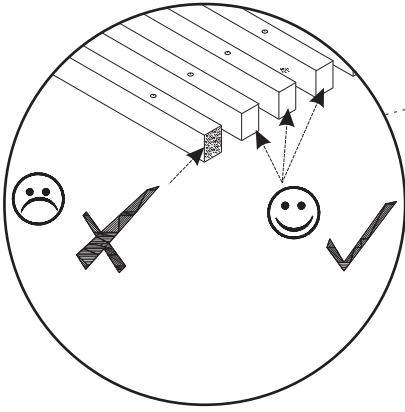

G4		B22	
x40		x45	Ø7x40

G12		G2	
x5	Ø14	x1	

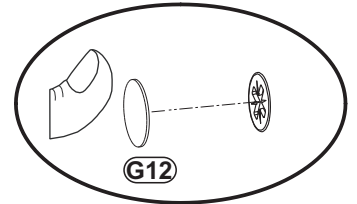
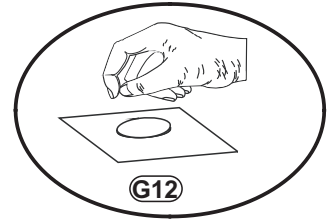
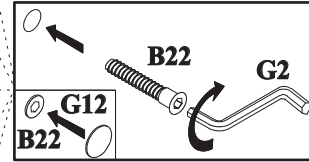

7

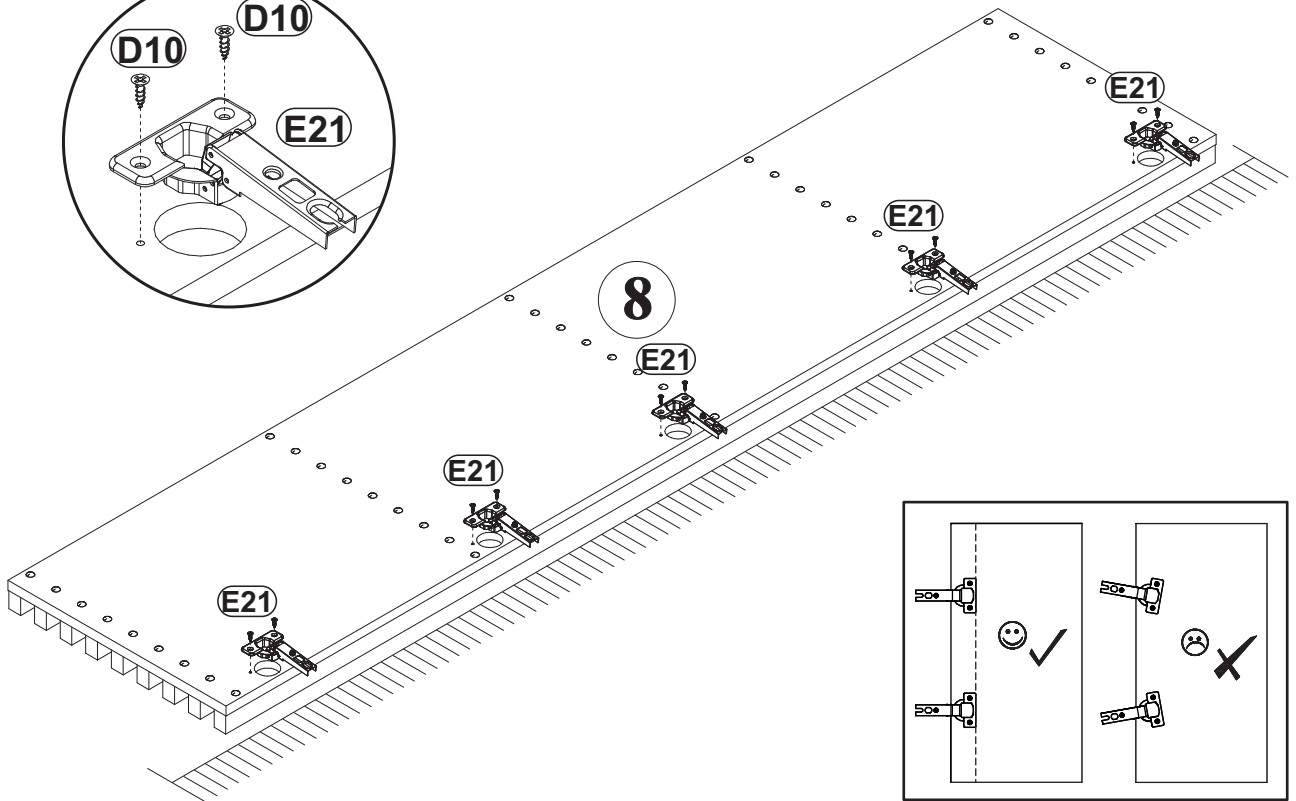
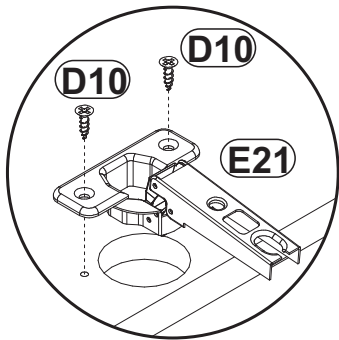

D10		E21	Ø35
x10	USØ3,5x13	x5	H=0

E21			
x5			

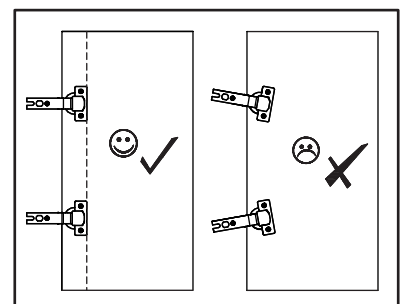

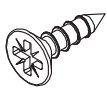
D10	
x8	USØ3,5x13

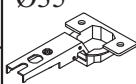
E21	
x4	Ø35 H=0

8

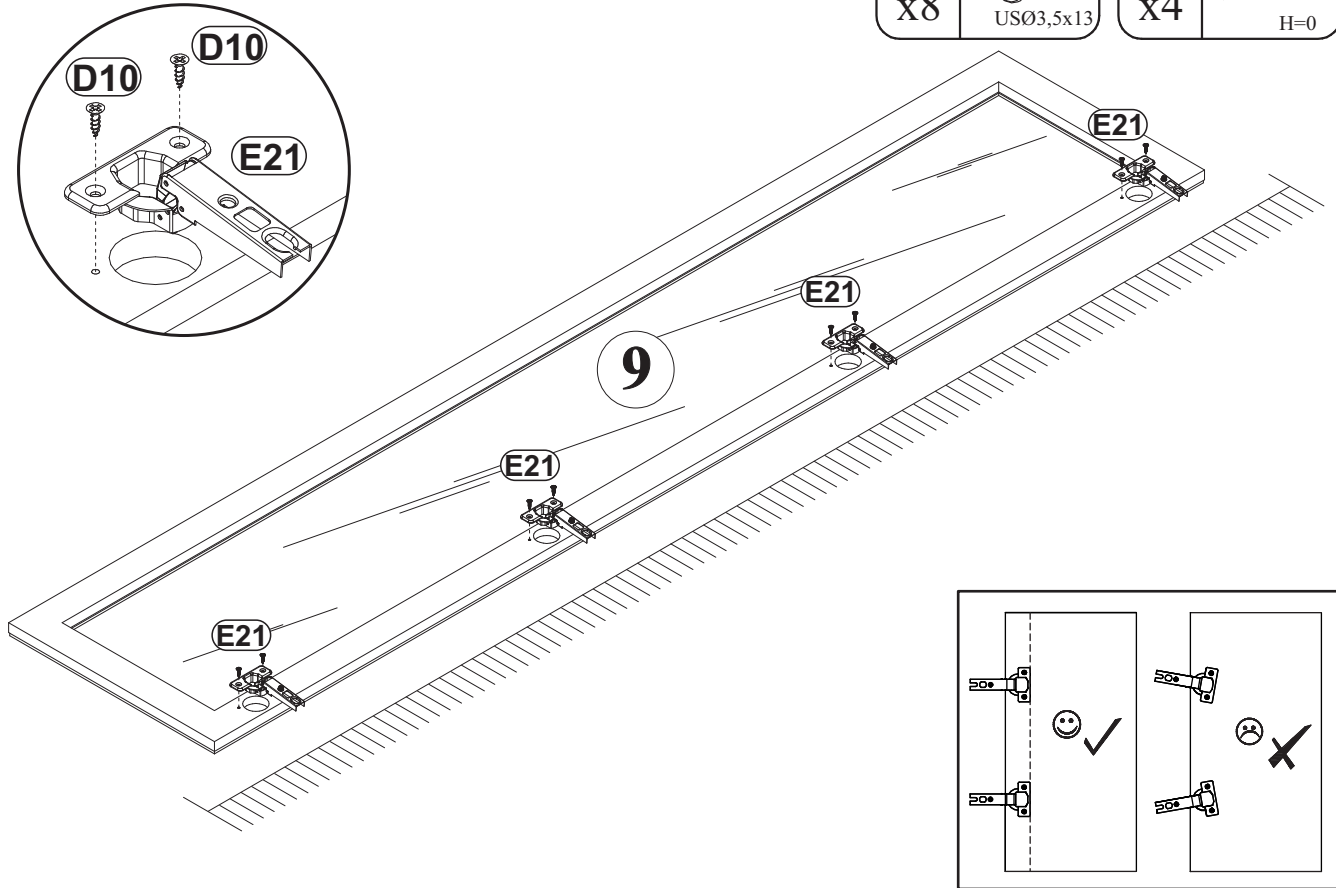

9

G5	
x4	

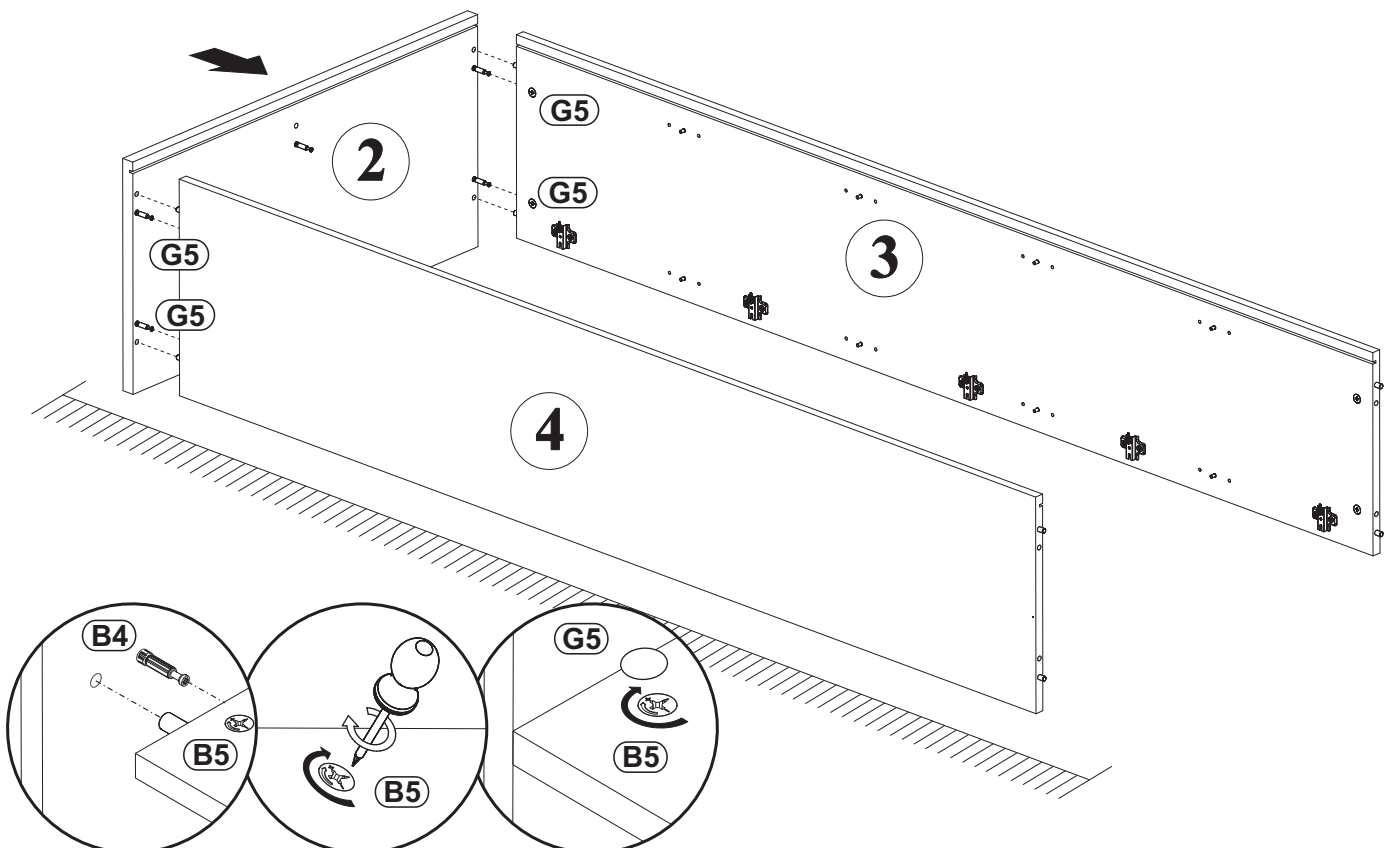

G5	
x2	

10

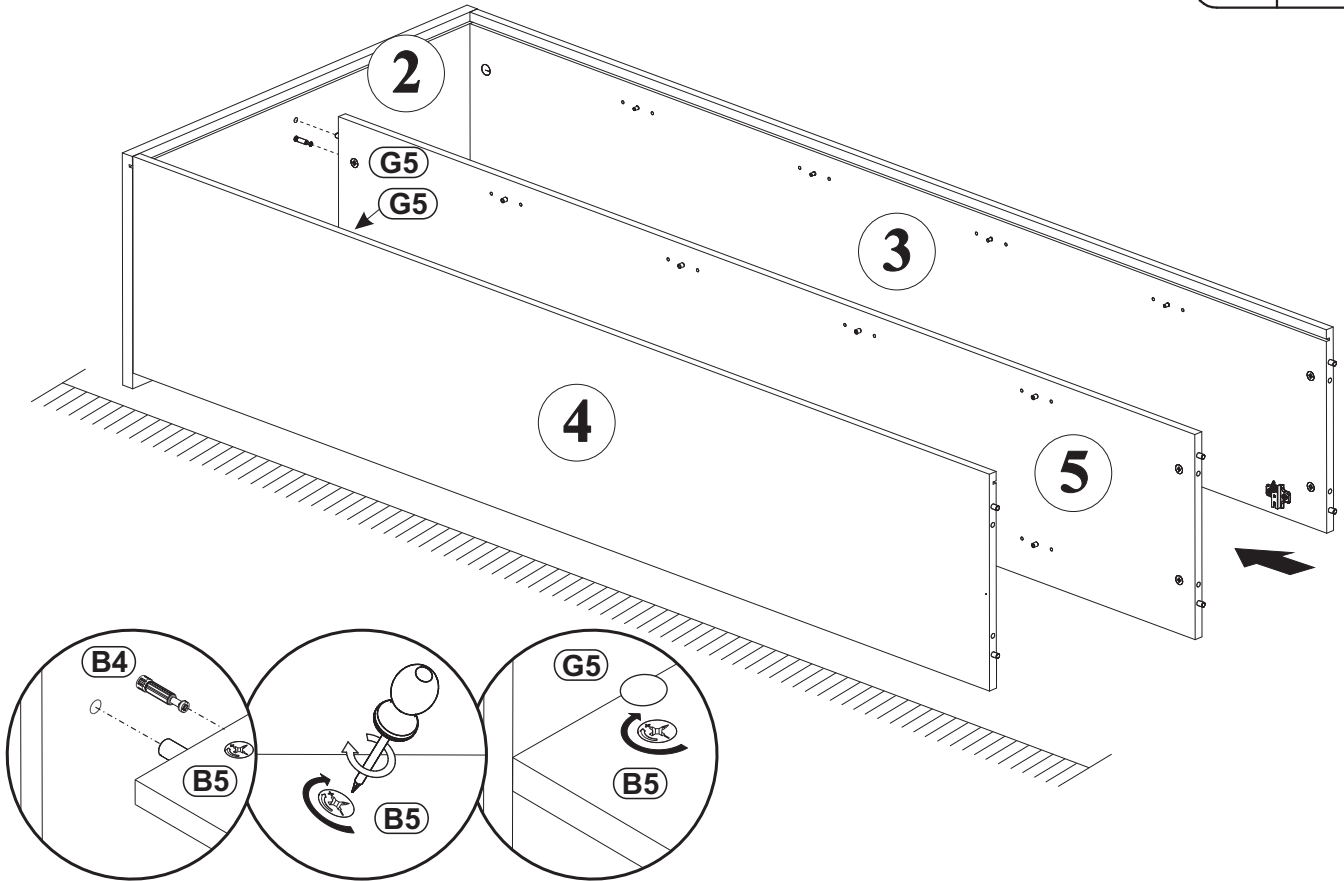

11

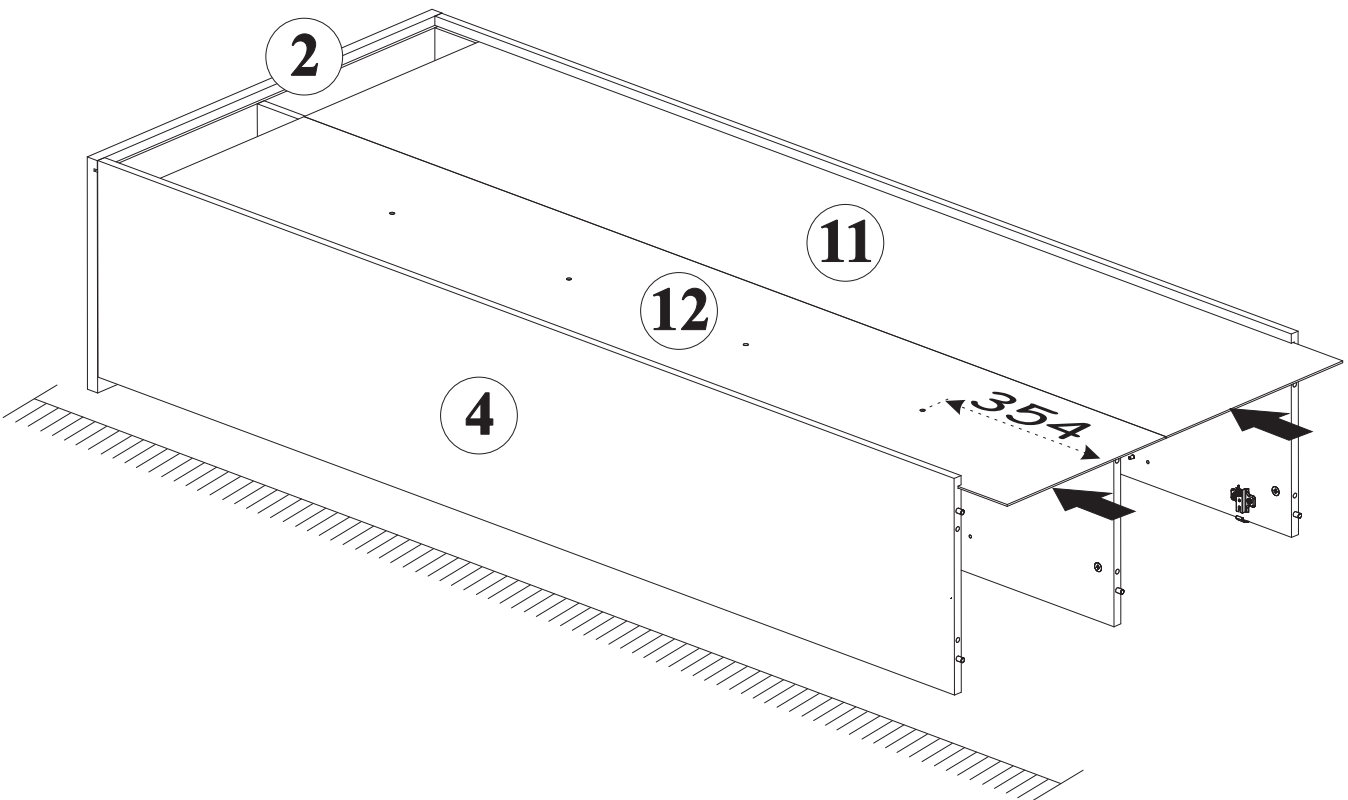

12

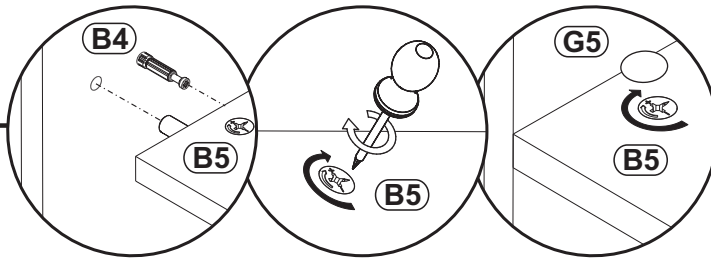
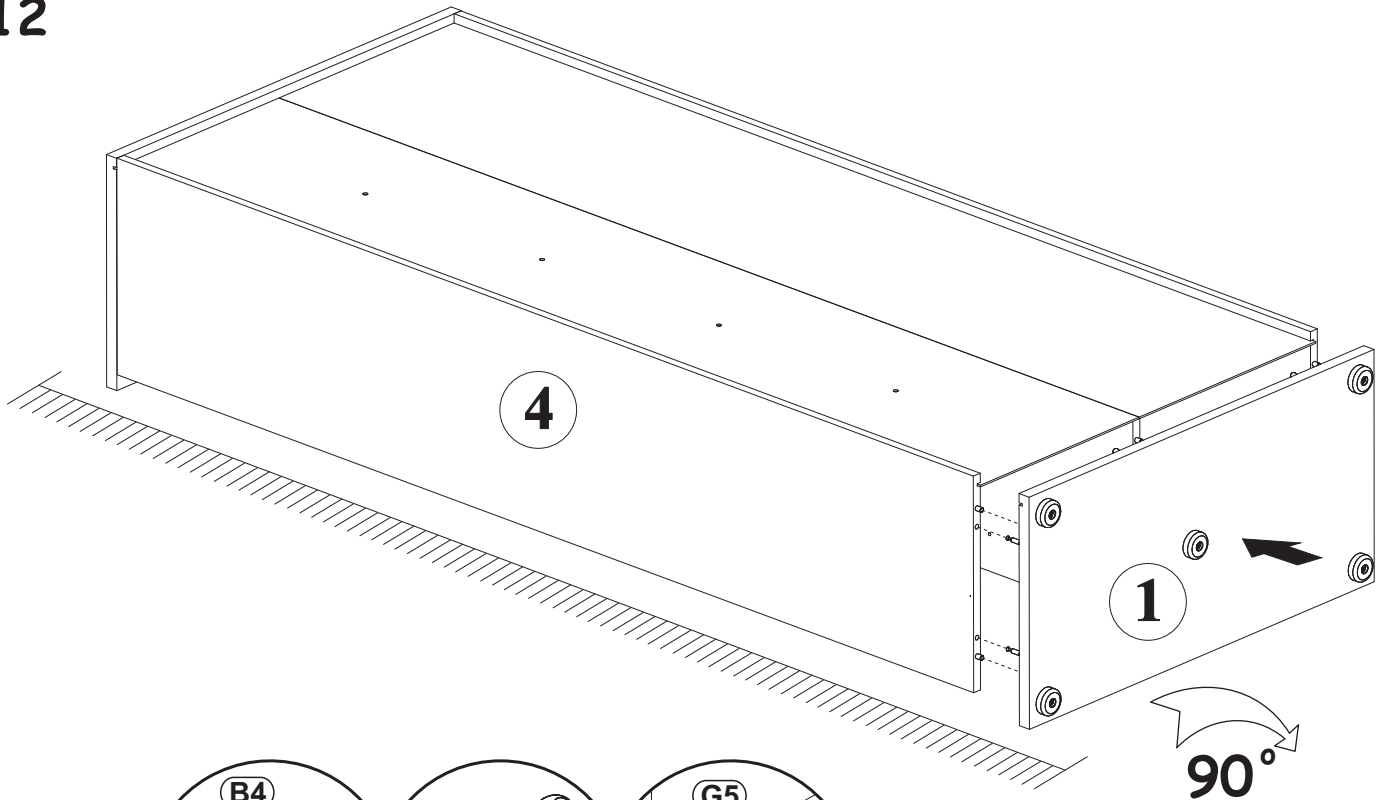

13

G5	
x6	

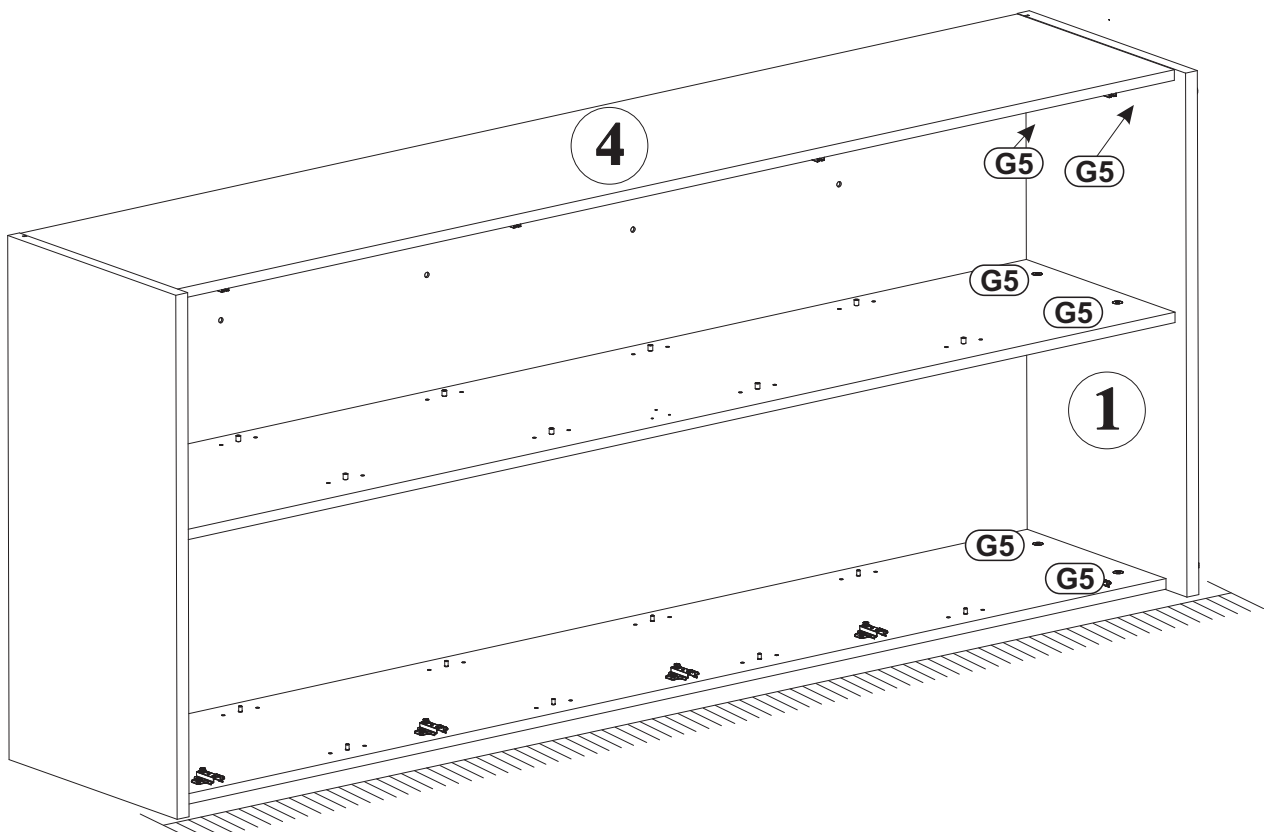

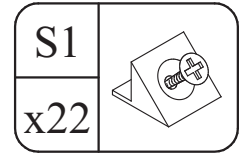
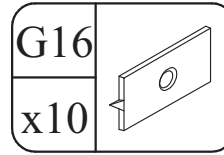
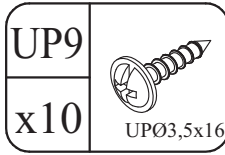

14

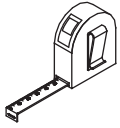

$X=Y$ 90°

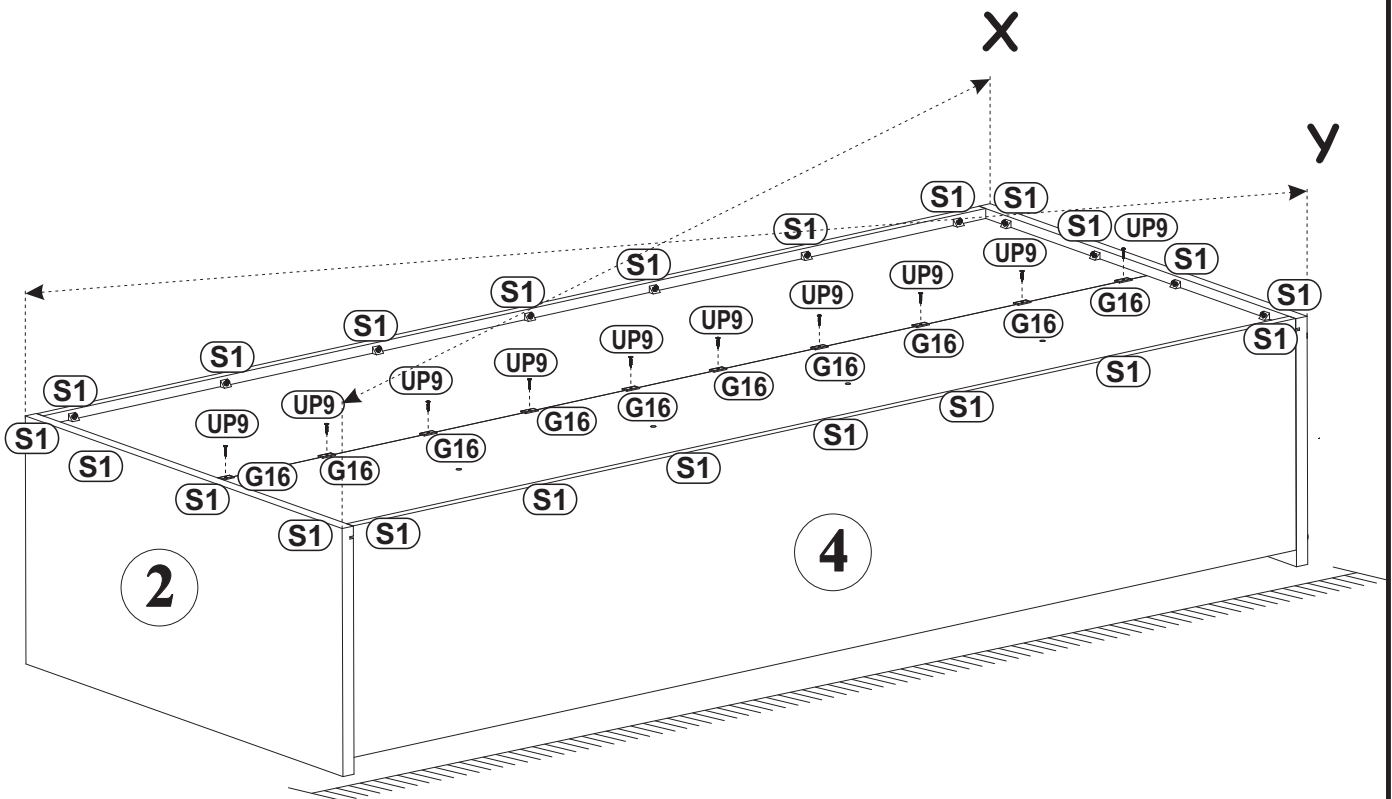
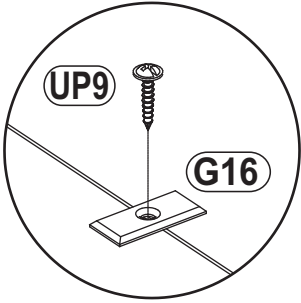

90°

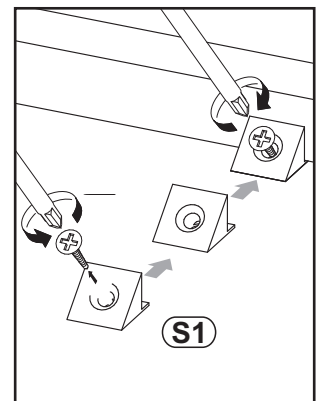

15

LED	
x1	1x4

D10	
x4	USØ3,5x13

KR1	
x1	Ø8

L1	
x1	

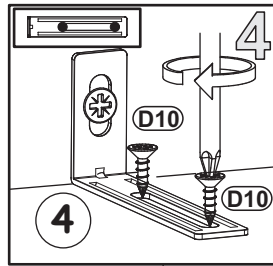
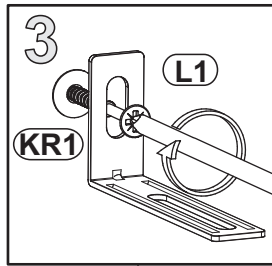
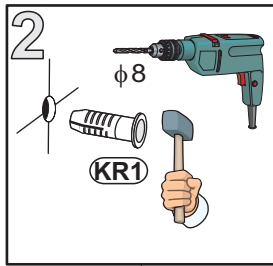
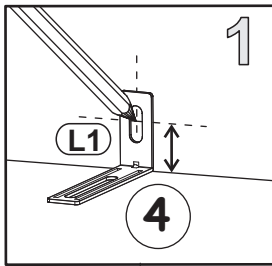

T3/T5	
x1	

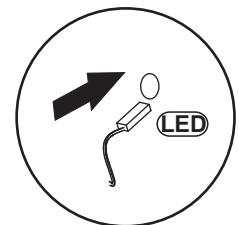
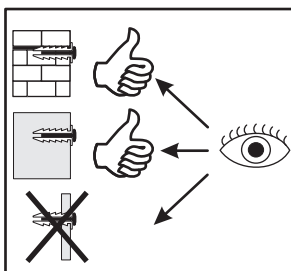
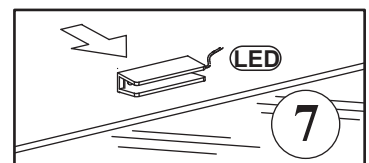
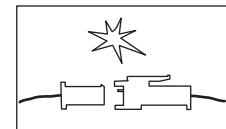
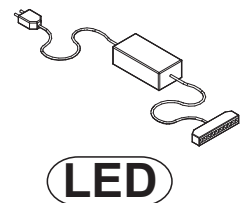
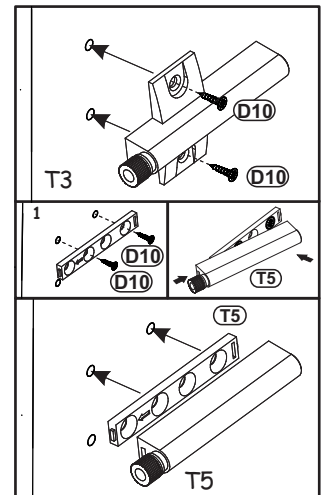
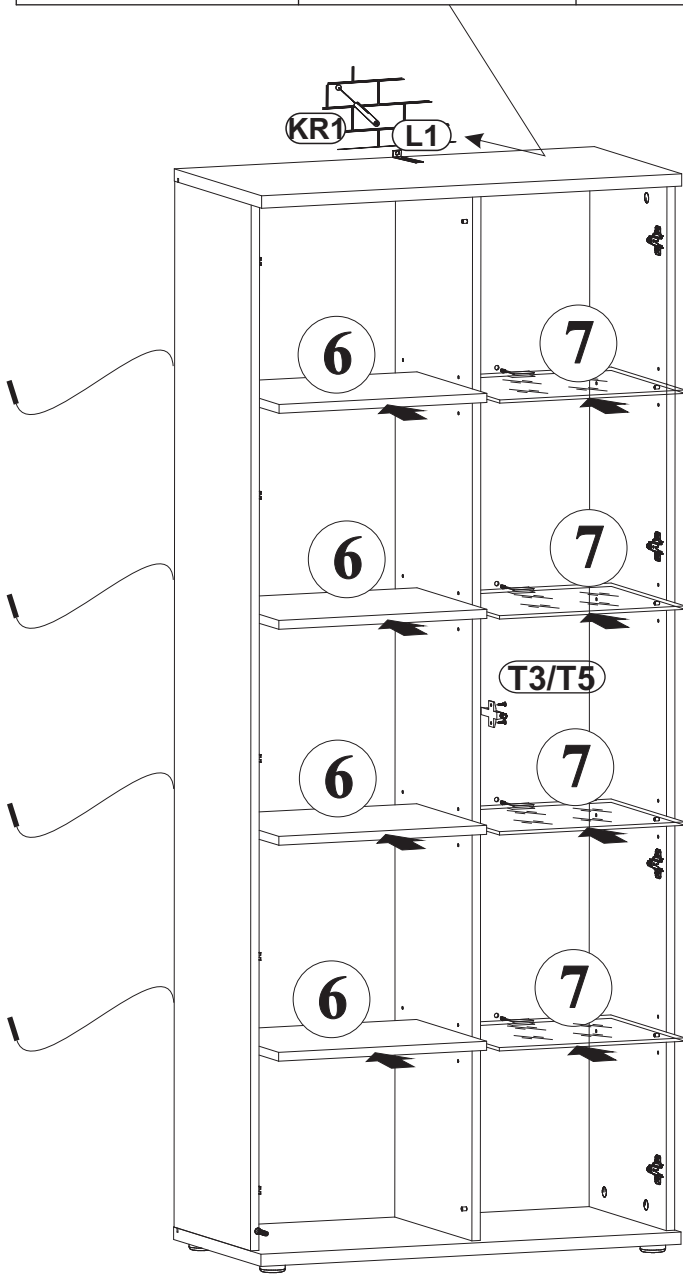

16

