

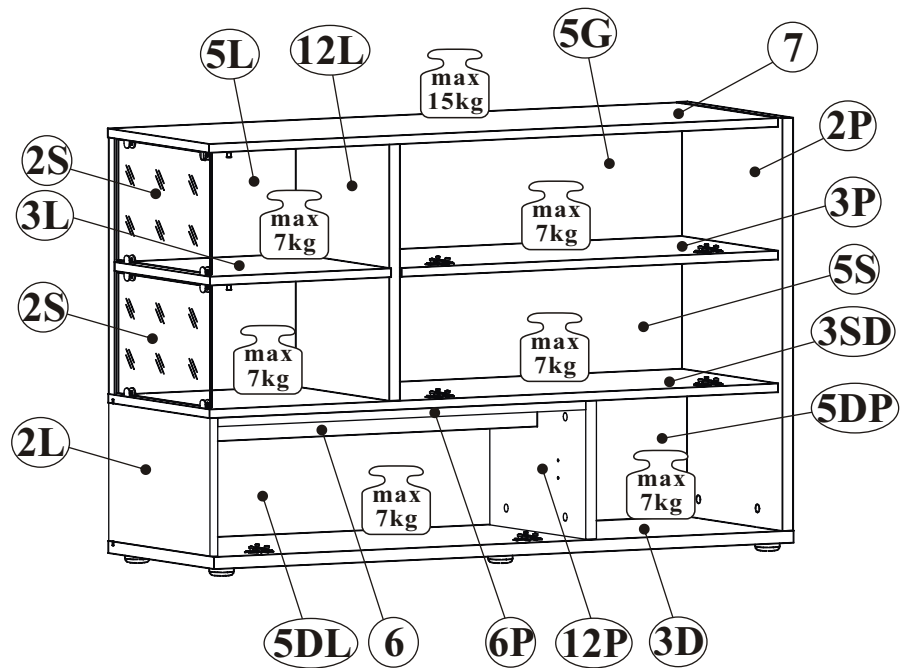

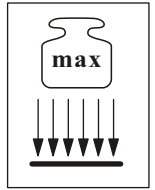

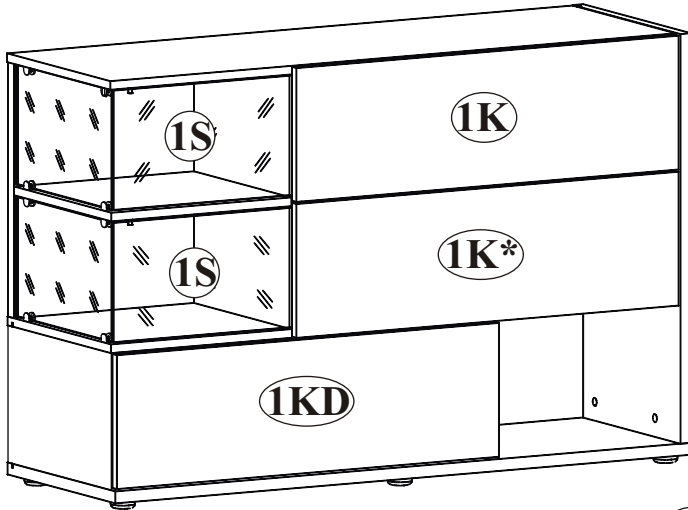

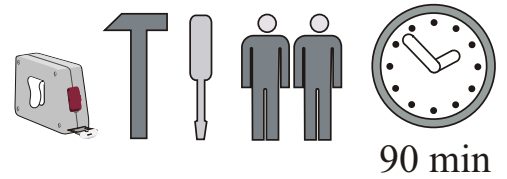



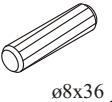
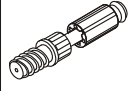



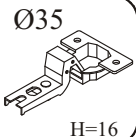
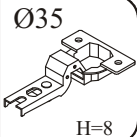
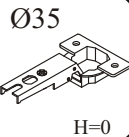
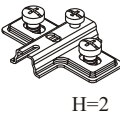
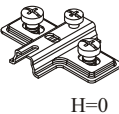

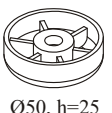
SILK 20_SKS

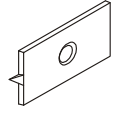

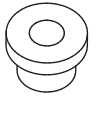
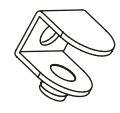
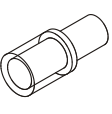
NO	Dim.			Col.-No	Qty
1K	796	246	16	1 / 2.	2
1S	393	220	4	1 / 2.	2
1KD	796	246	16	1 / 2.	1
2S	355	220	4	1 / 2.	2
2L	252	384	16	1 / 2.	1
12P	252	364	22	1 / 2.	1
5S	239	791	3	1 / 2.	1
5G	239	791	3	1 / 2.	1
6	762	60	16	1 / 2.	1
6P	762	60	16	1 / 2.	1
2P	753	401	22	2 / 2.	1
12L	468	377	22	2 / 2.	1
3D	1200	401	22	2 / 2.	1
3SD	1177	384	16	2 / 2.	1
3L	375	362	16	2 / 2.	1
3P	779	364	16	2 / 2.	1
5L	468	375	22	2 / 2.	1
5DP	376	252	22	2 / 2.	1
5DL	788	264	3	2 / 2.	1
7	1178	384	16	2 / 2.	1

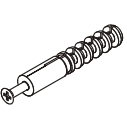
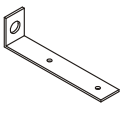

90 min

A1 x38 	B4 x30 	B5 x16 	B16 x14 	G5 x30 	OD2 x3 
E25 x2 Ø35 H=16 	E23 x2 Ø35 H=8 	E21 x2 Ø35 H=0 	E4 x2 H=2 	E2 x4 H=0 	D10 x34 USØ3,5x13 
I11 x6 Ø50, h=25 	UP11 x6 UPØ4x20 	G16 x6 	UP13 x15 UPØ3x16 	P2 x6 	G31 x8 
G20 x2 	G21 x3 	D7 x9 USØ3x16 	UP12 x3 UPØ3,5x30 	KR1 x1 	L1 x1 
G2 x1 					

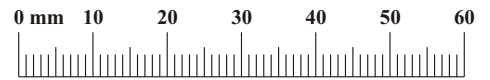

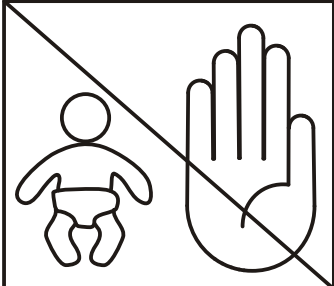

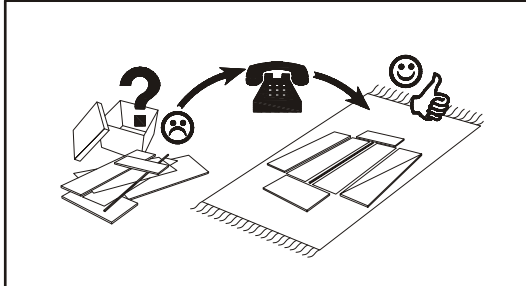

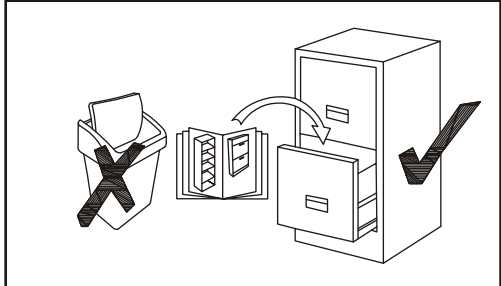

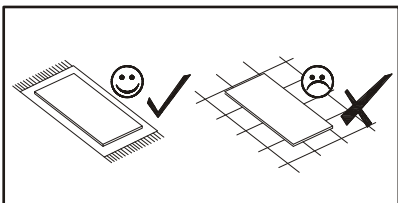

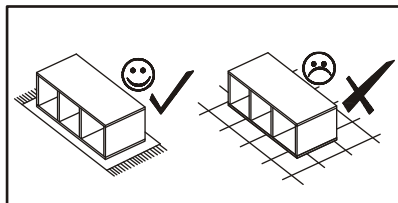

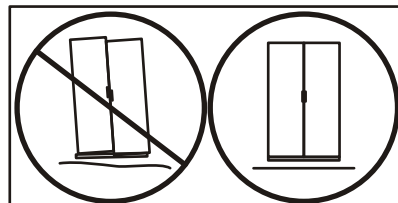

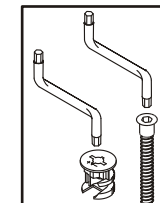





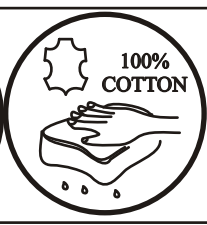





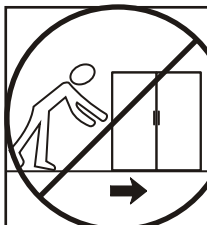

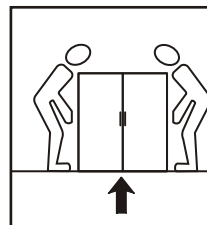

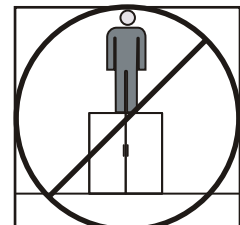

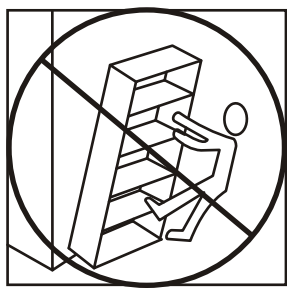

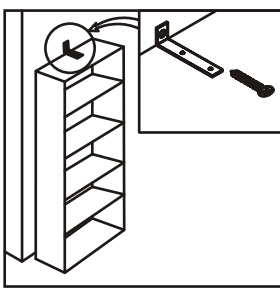





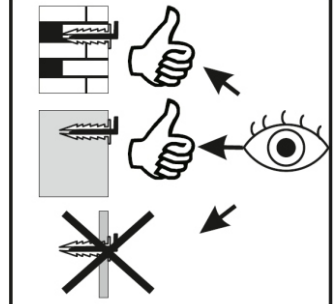

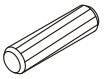

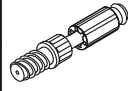
A1	
x6	ø8x36

B4	
x10	

B16	
x6	Ø15x16

1

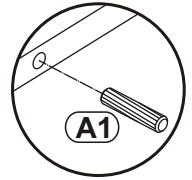
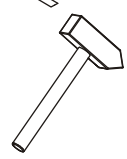
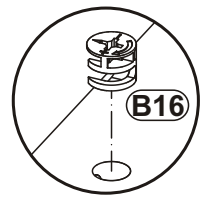
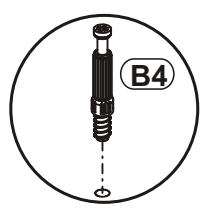
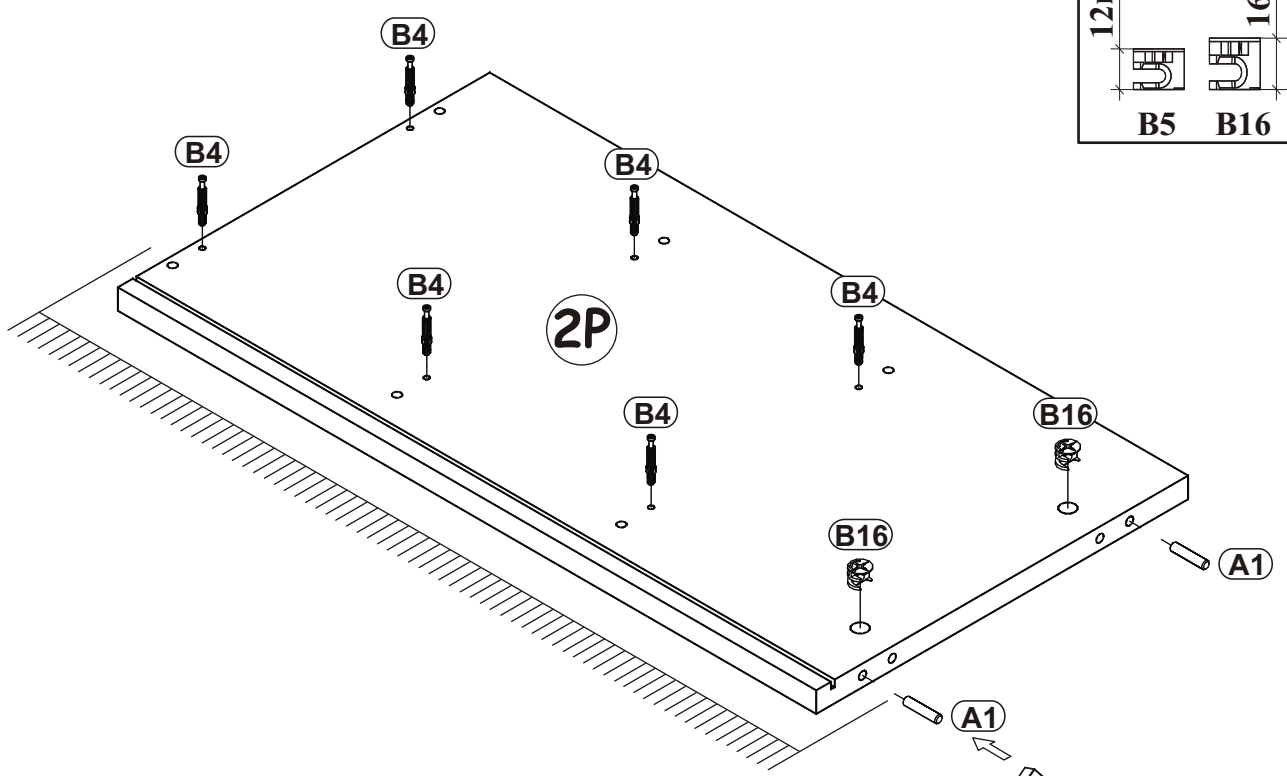
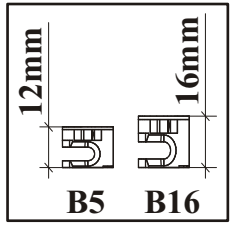

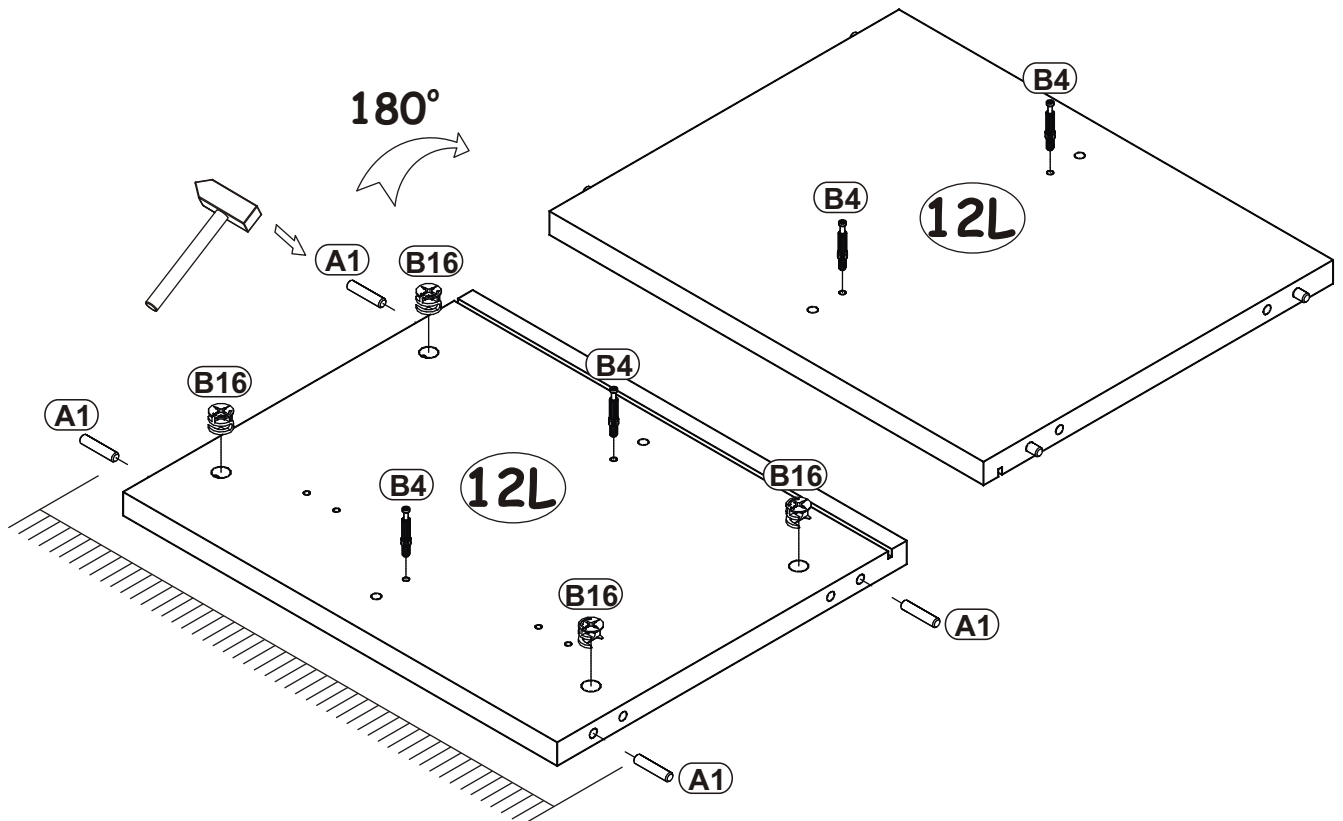

180°

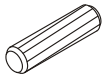

2

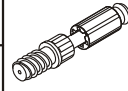
A1	
x12	ø8x36

B4	
x2	

B16	
x8	Ø15x16

B5	
x4	Ø15x12

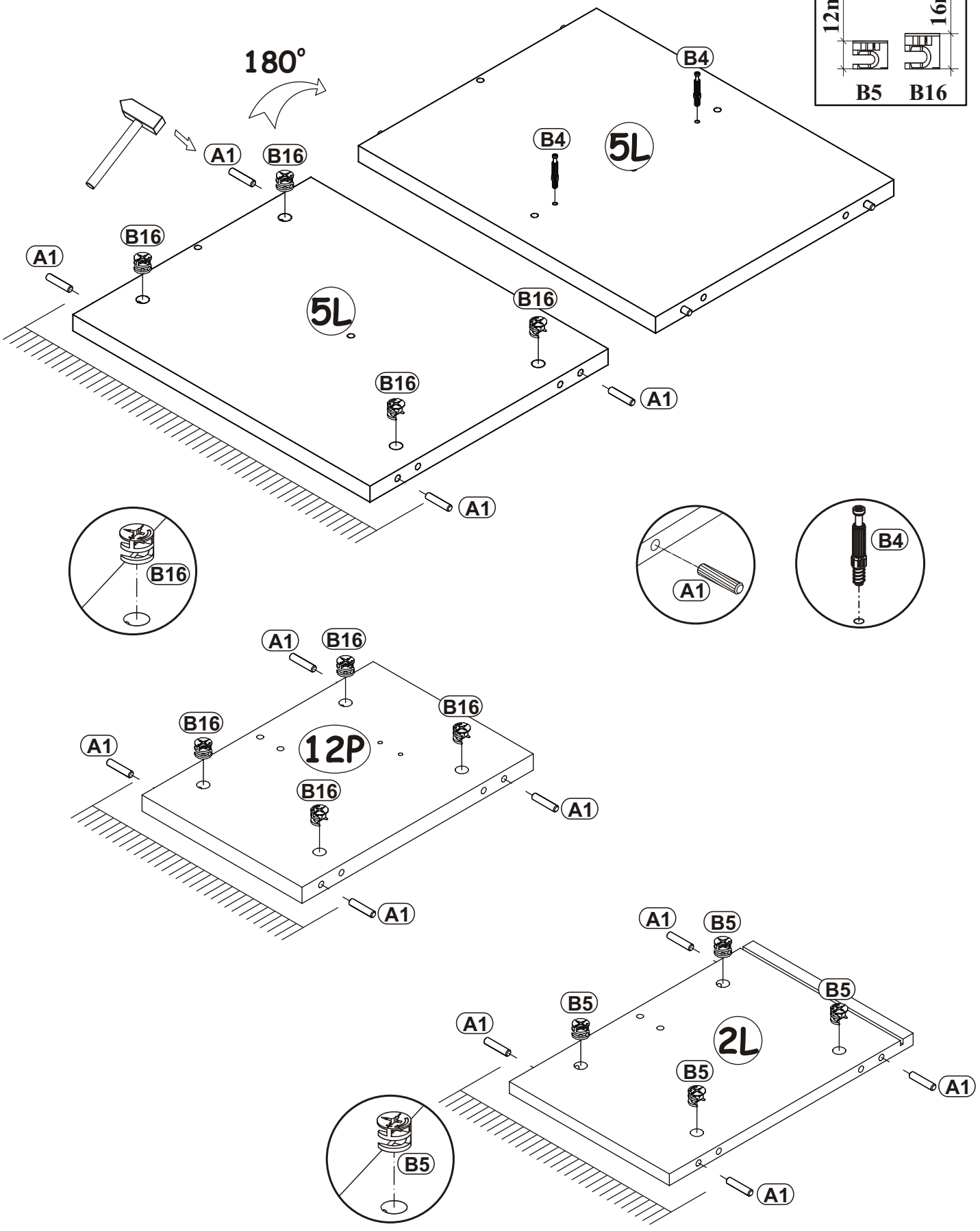
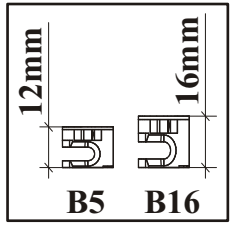

3

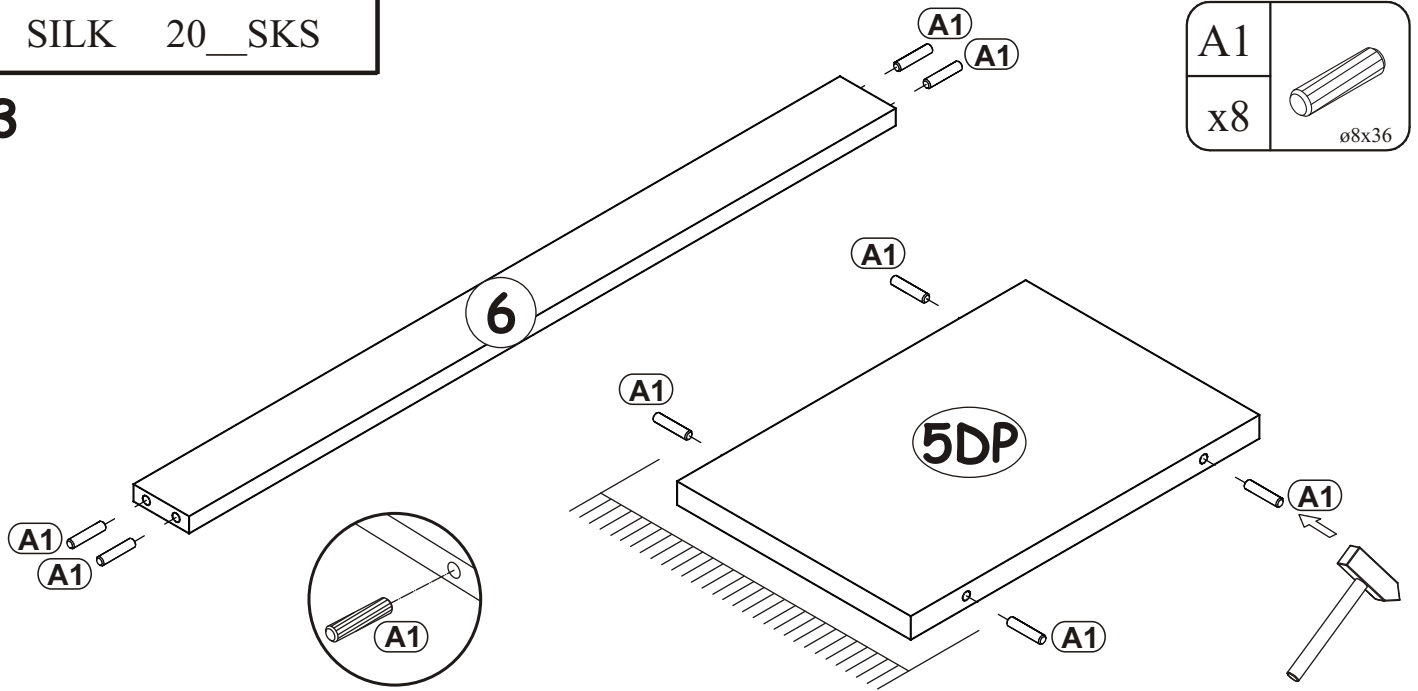

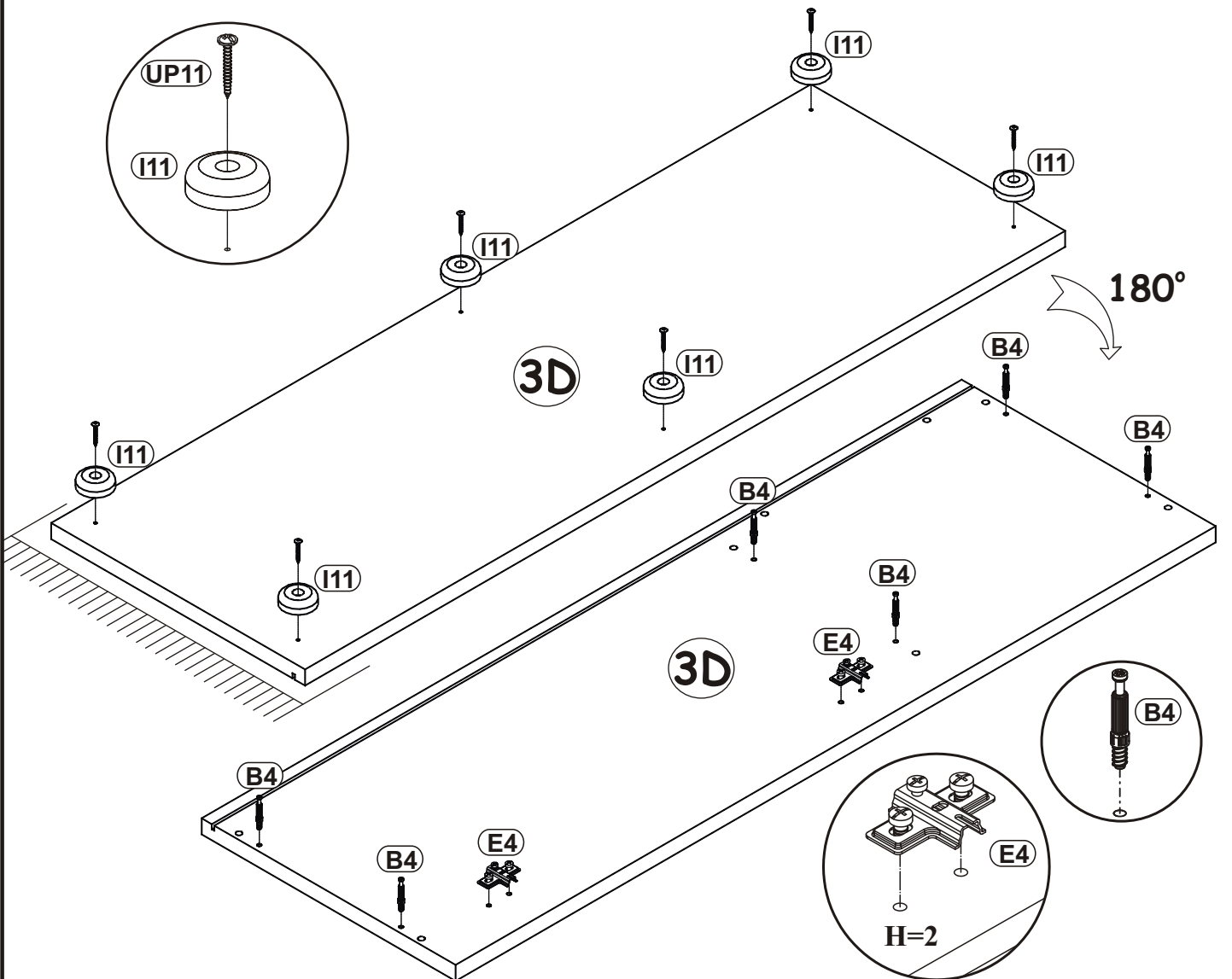
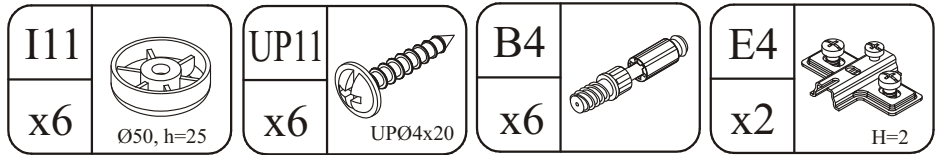

4

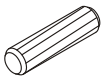

5

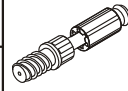
A1	
x4	ø8x36

B4	
x12	

B5	
x4	Ø15x12

G31	
x4	

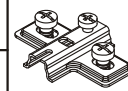
E2	
x2	H=0

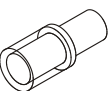
G20	
x1	

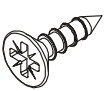
D10	
x4	USØ3,5x13

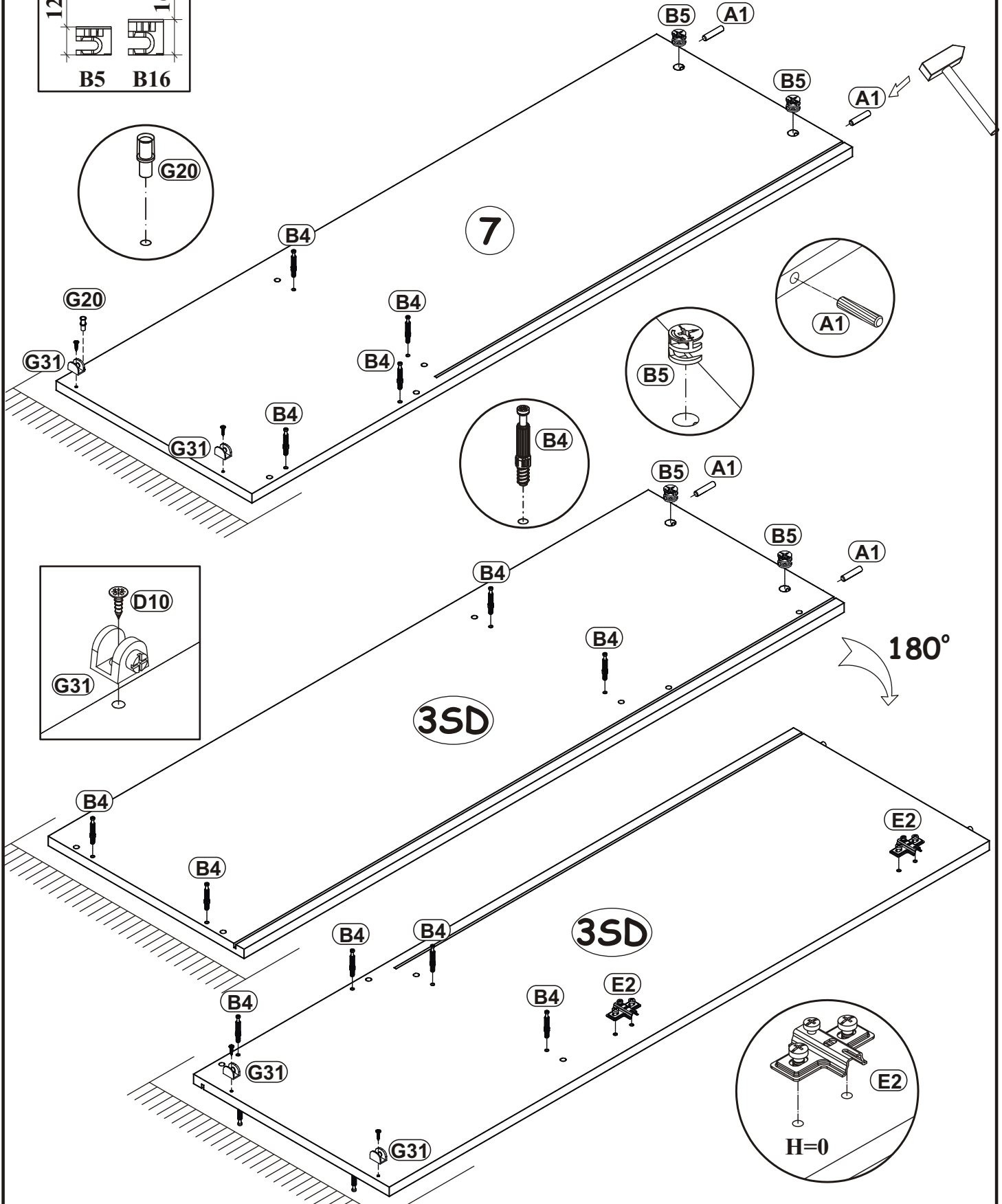
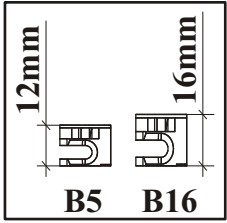

6

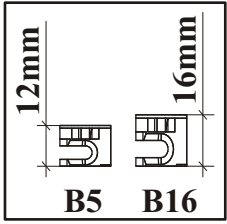

A1	
x8	ø8x36

B5	
x8	Ø15x12

G31	
x4	

D10	
x4	USØ3,5x13

G20	
x1	

E2	
x2	H=0

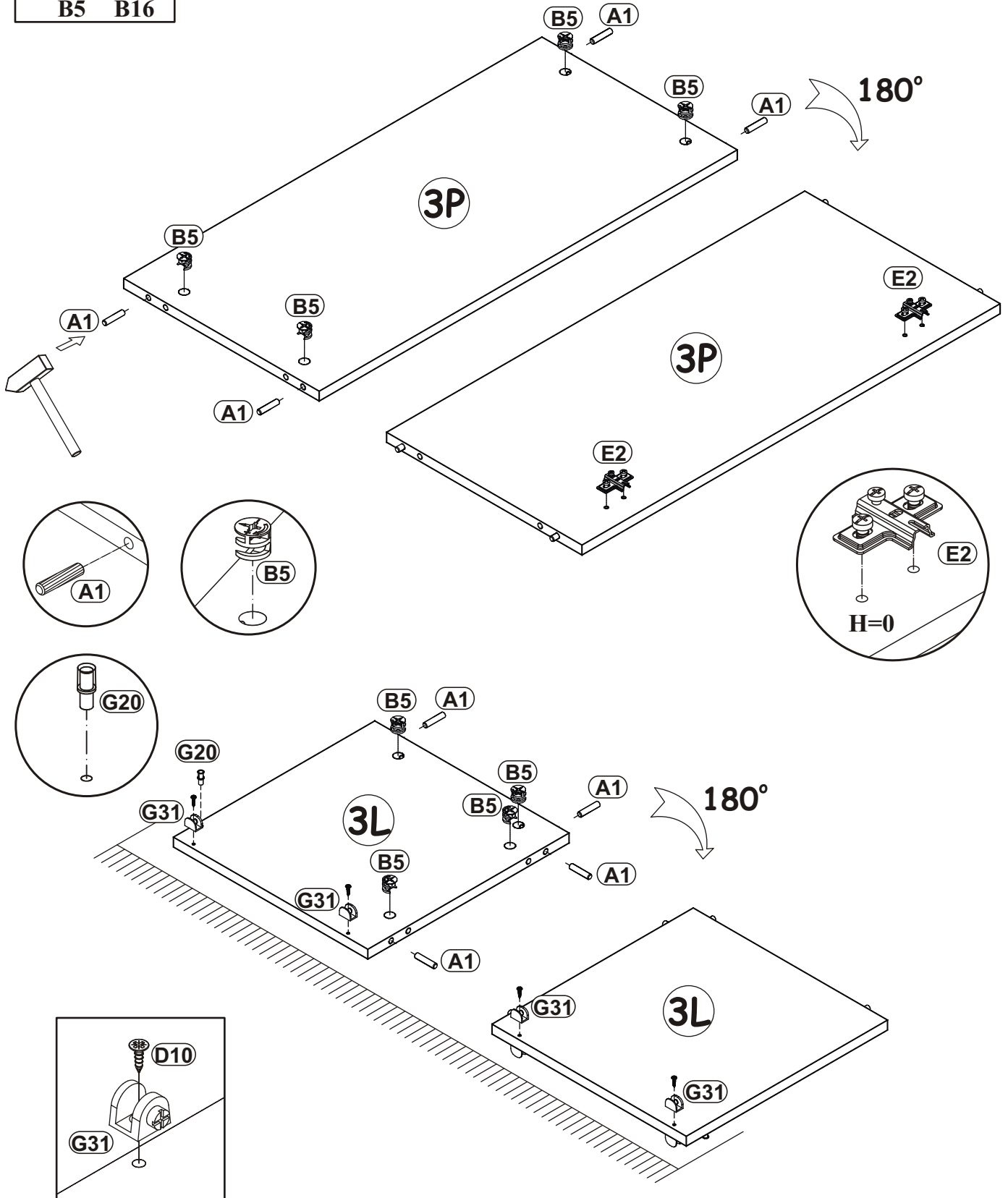

7

E25	Ø35	
x2		H=16

E23	Ø35	
x2		H=8

E21	Ø35	
x2		H=0

D10	
x12	USØ3,5x13

P2	
x6	

UP13	
x6	UPØ3x16

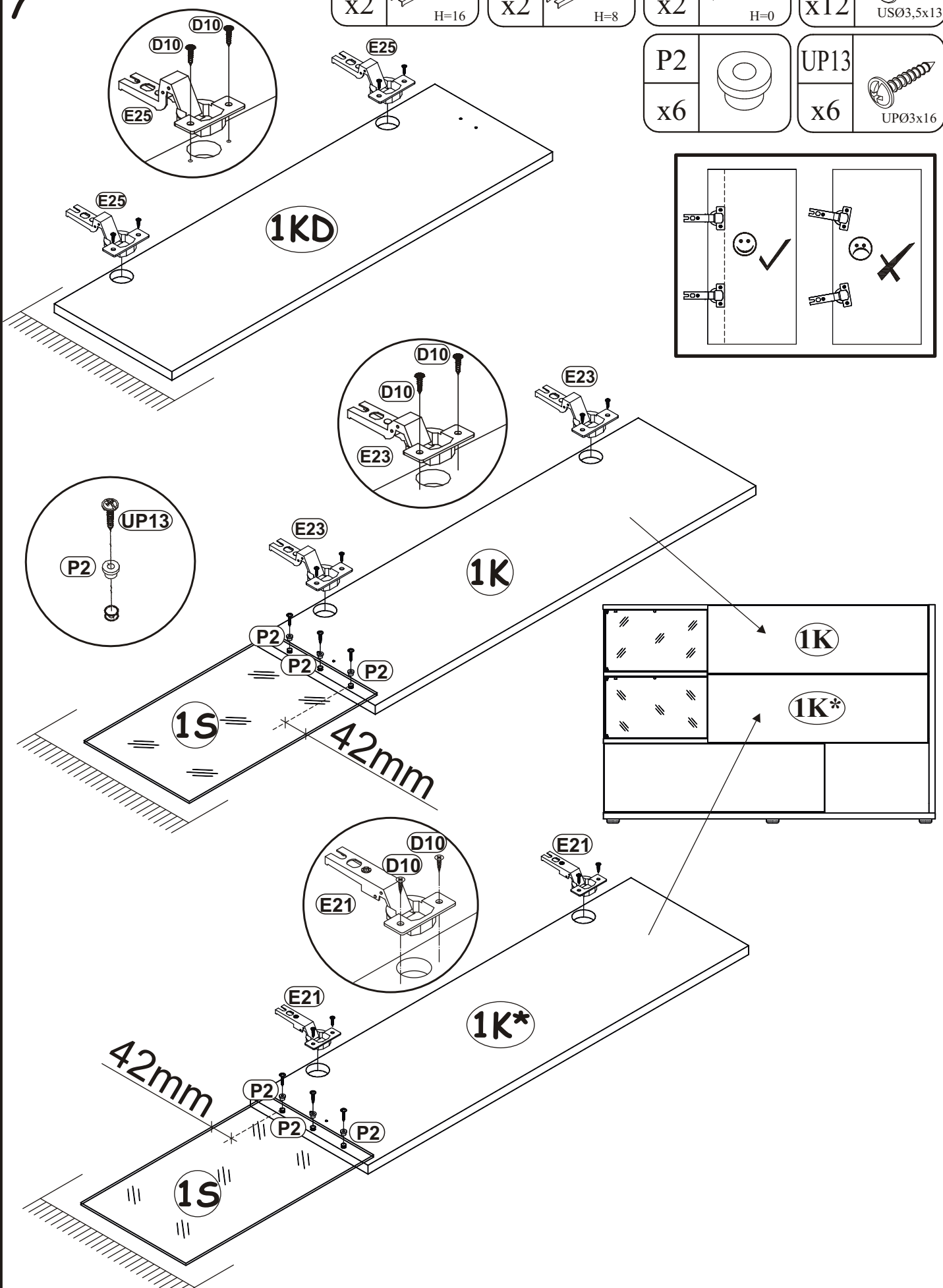
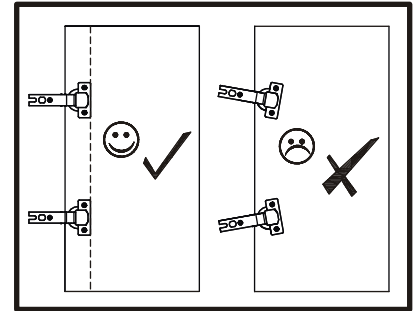

G5



x4

8

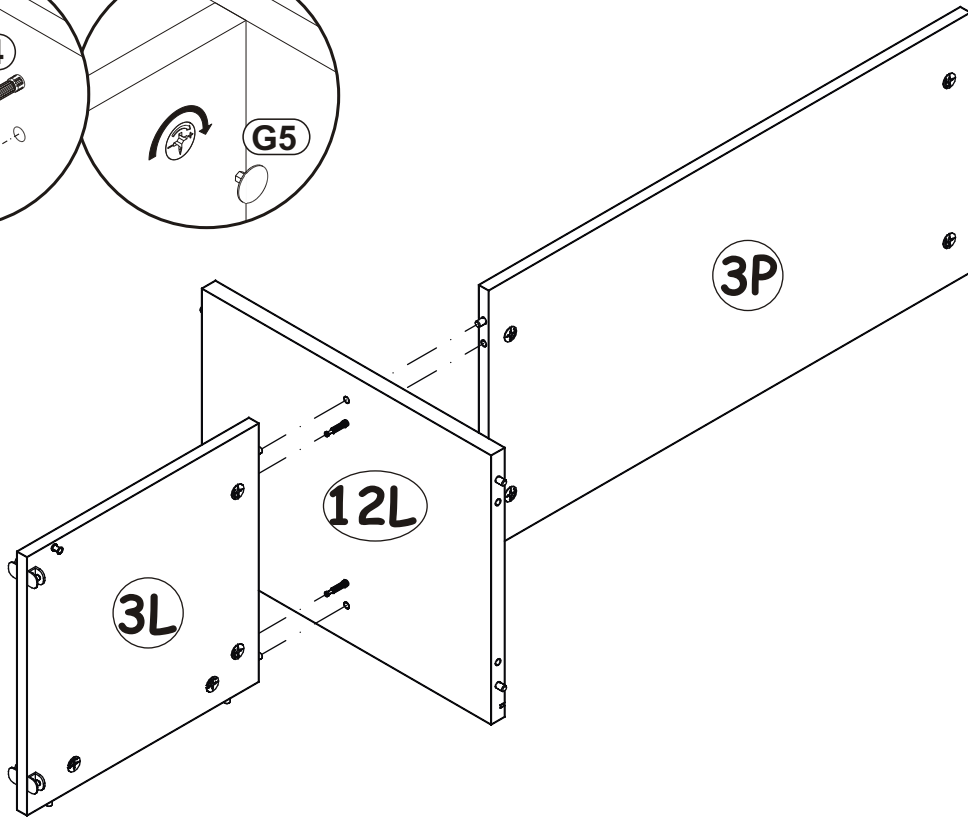
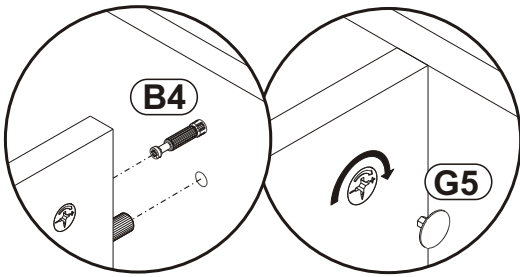

9

G5



x2

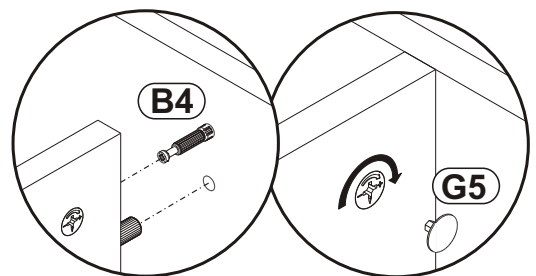
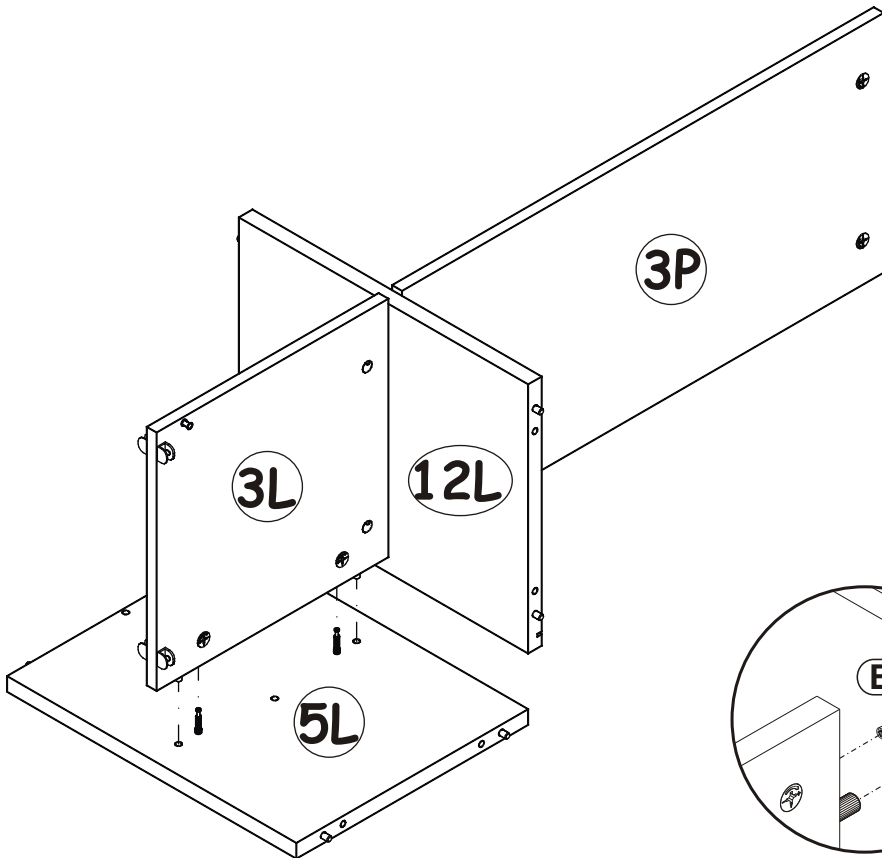



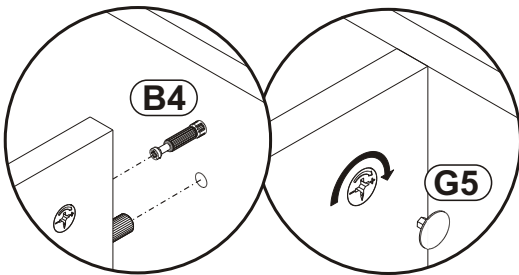
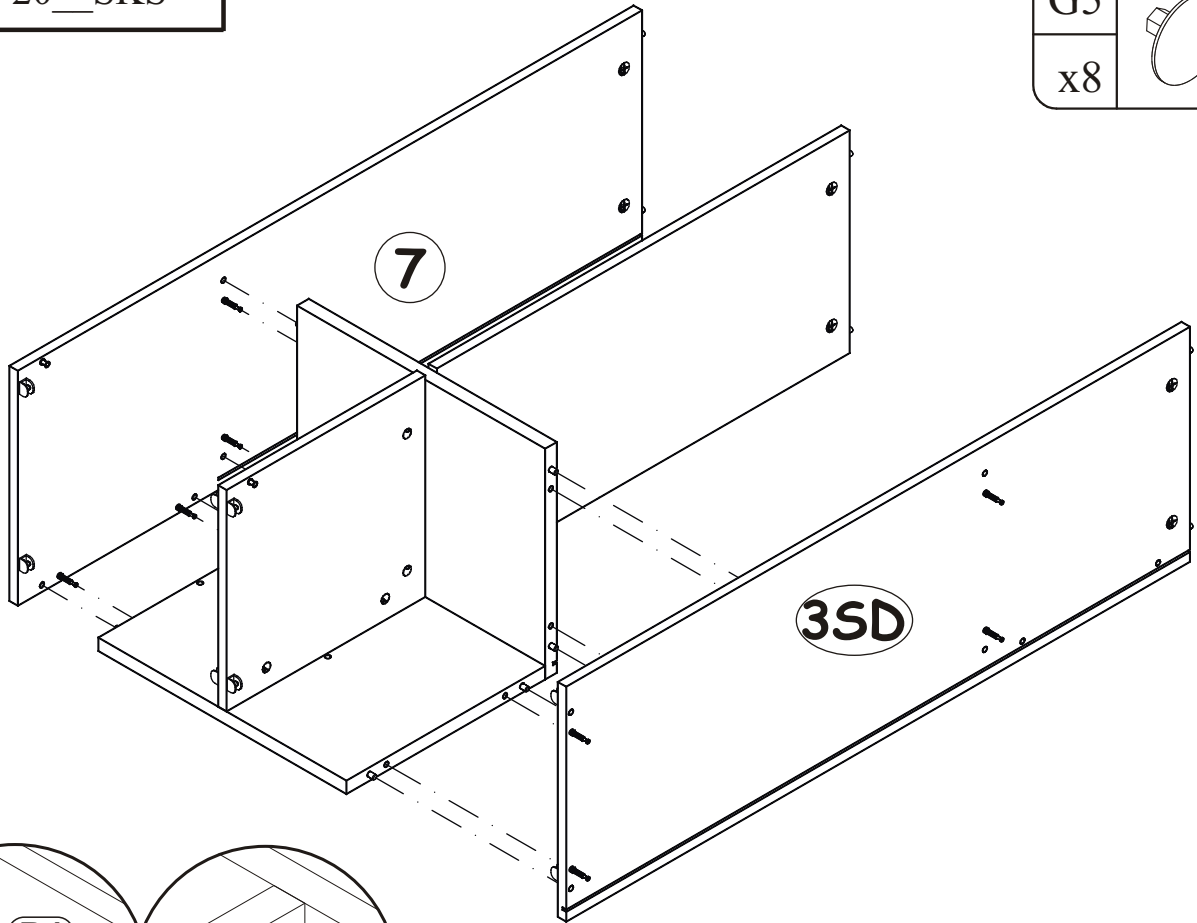

10

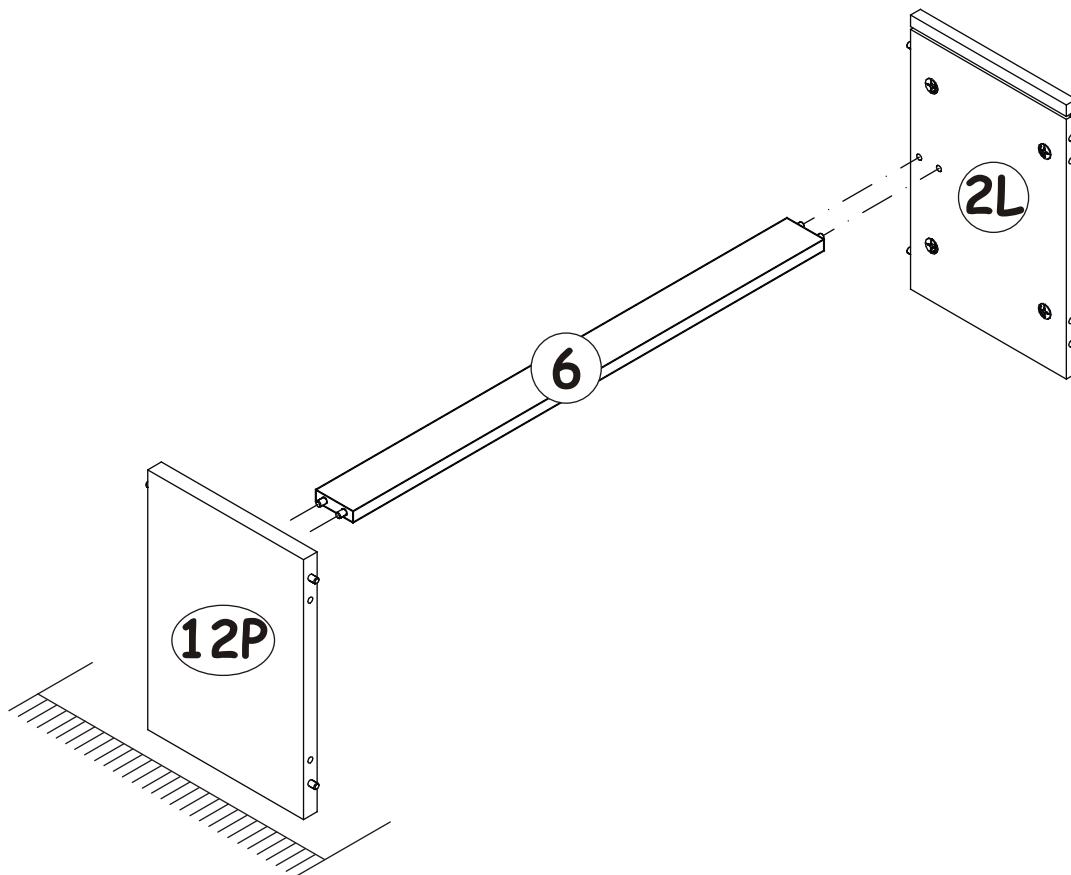

11



12

G5	
x10	

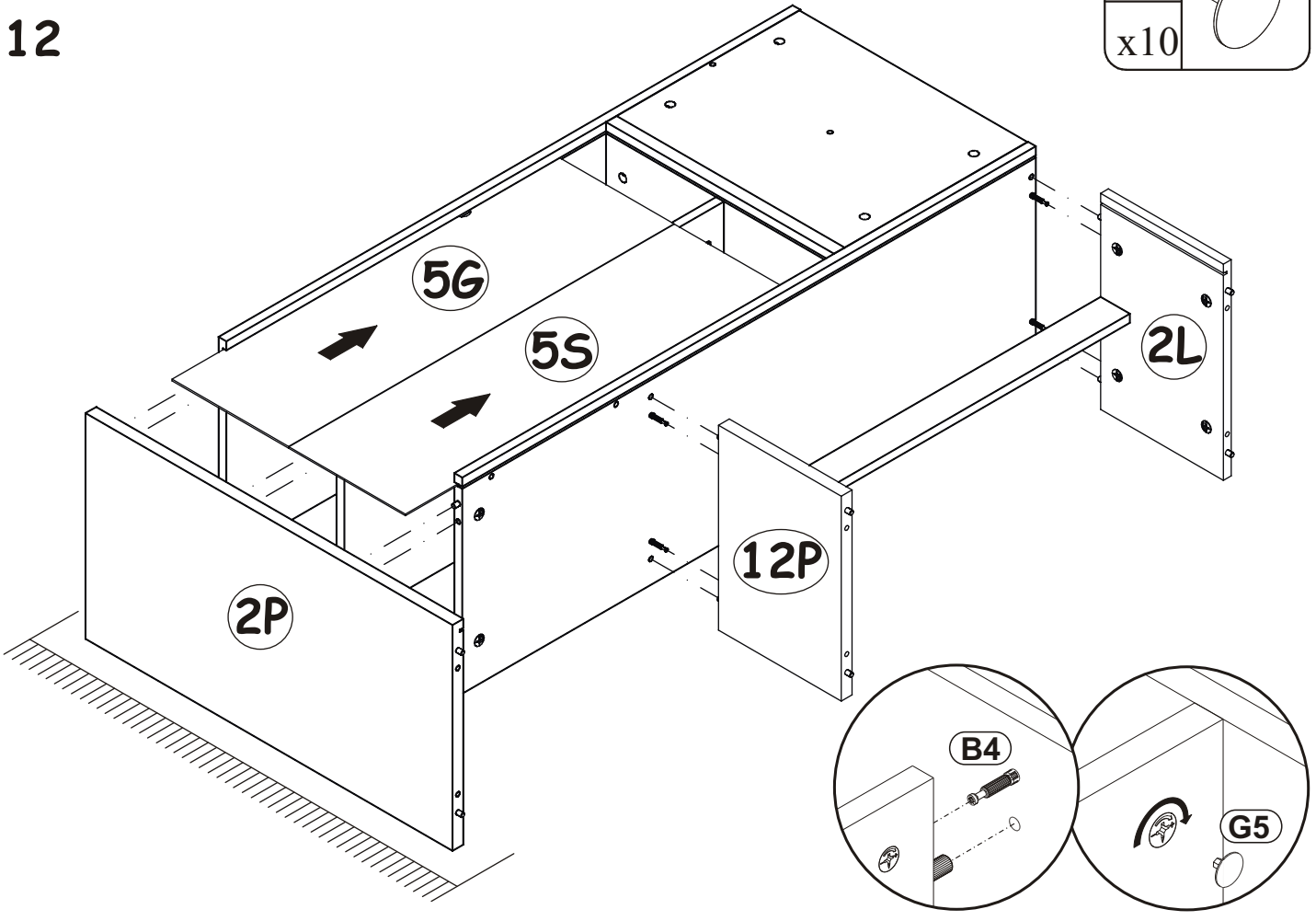

13

UP12	
x3	UPØ3,5x30

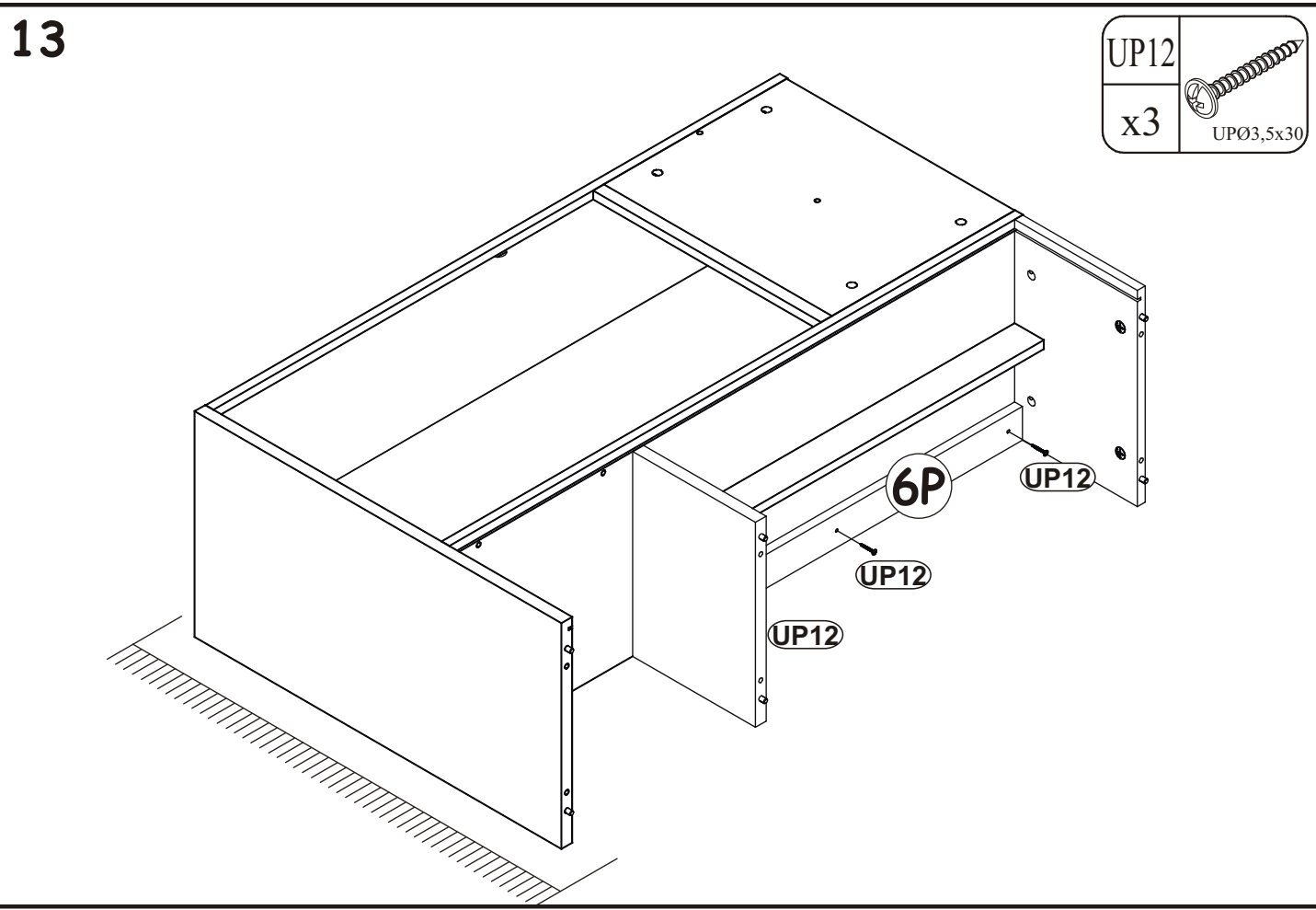

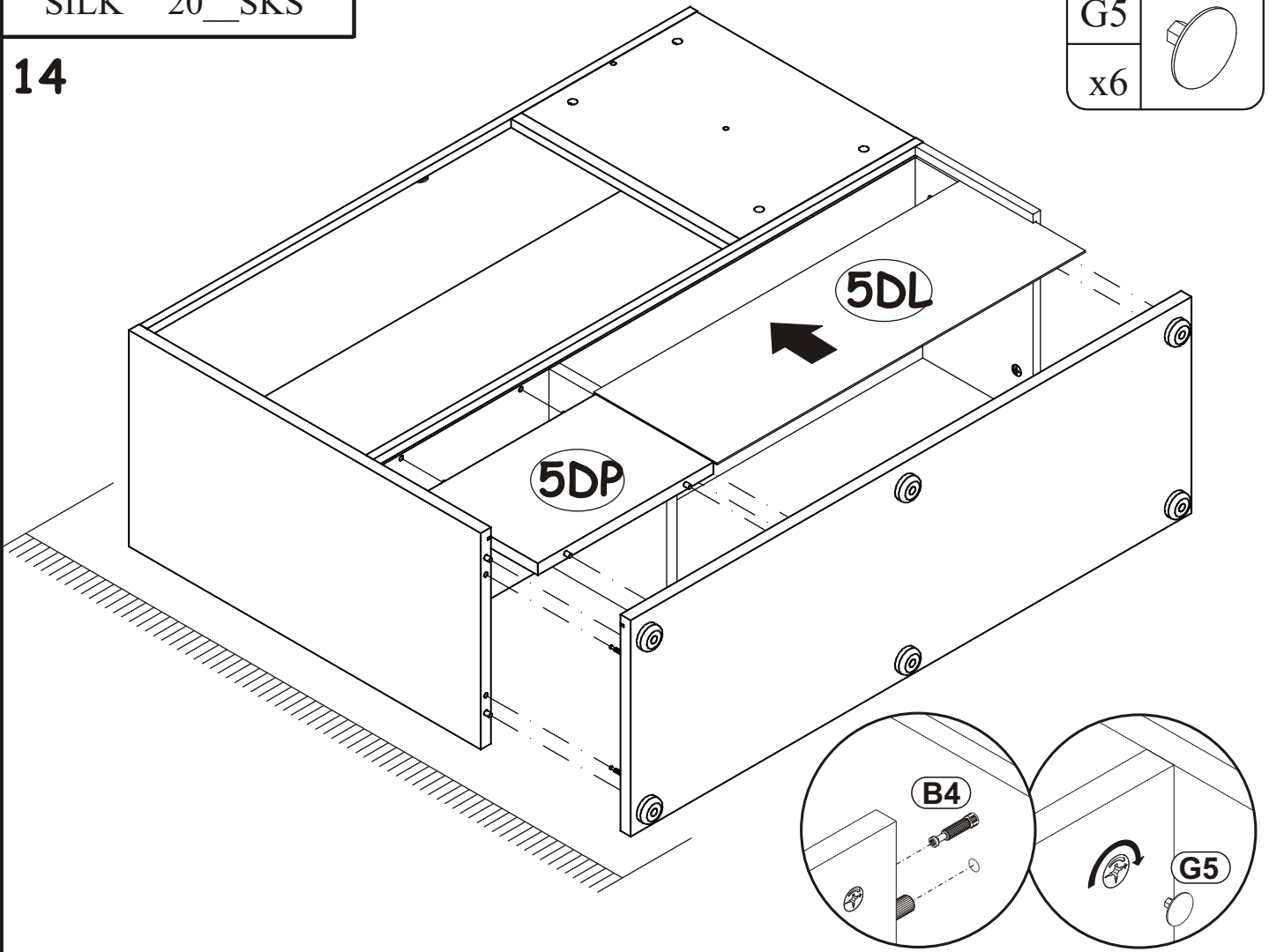

14

G5	
x6	

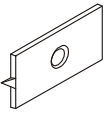

15

G16	
x6	

UP13	
x9	UPØ3x16

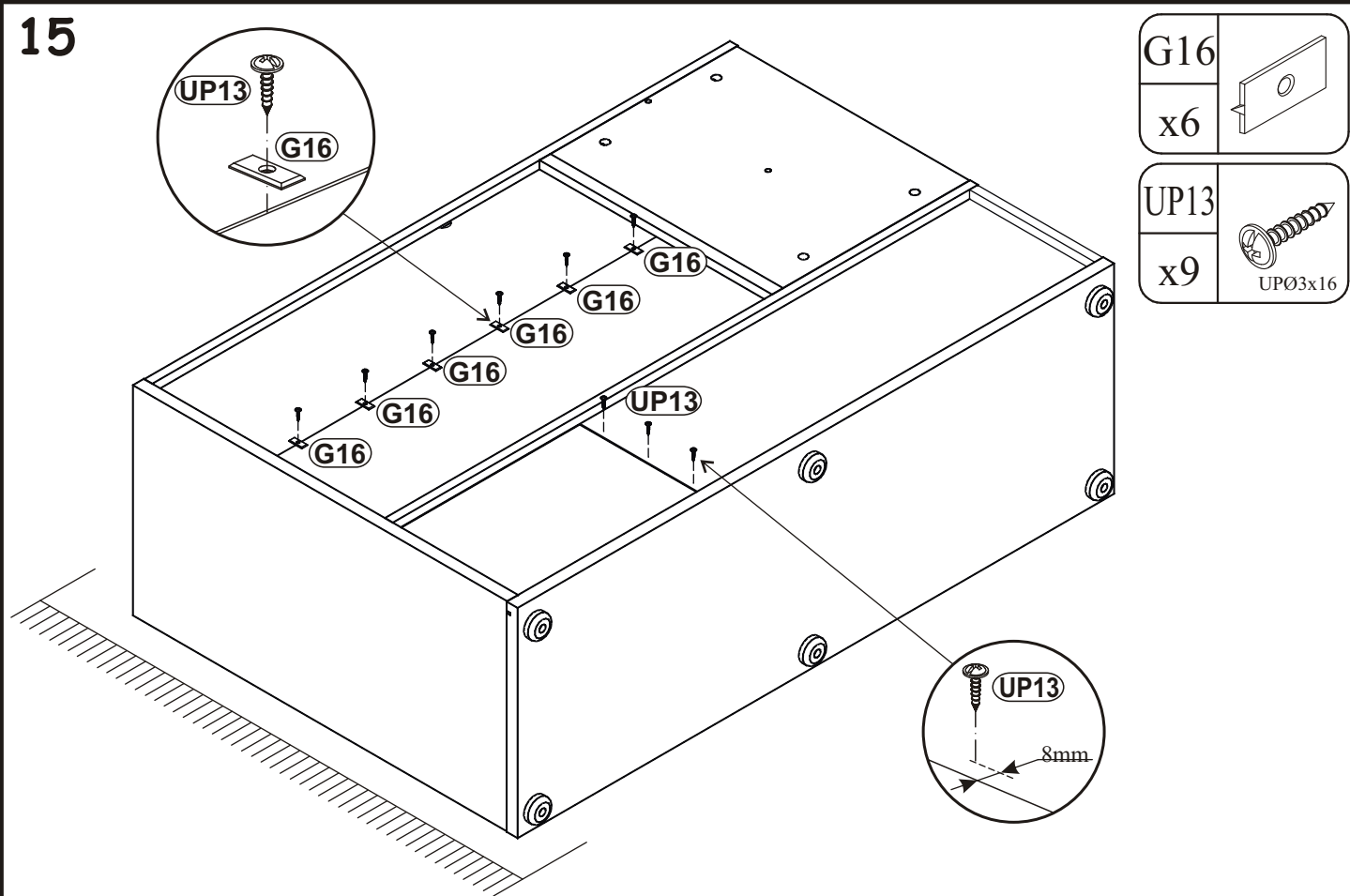

16

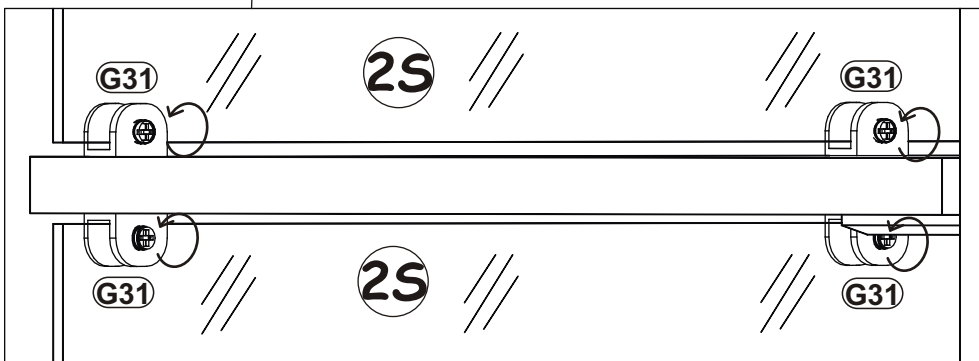
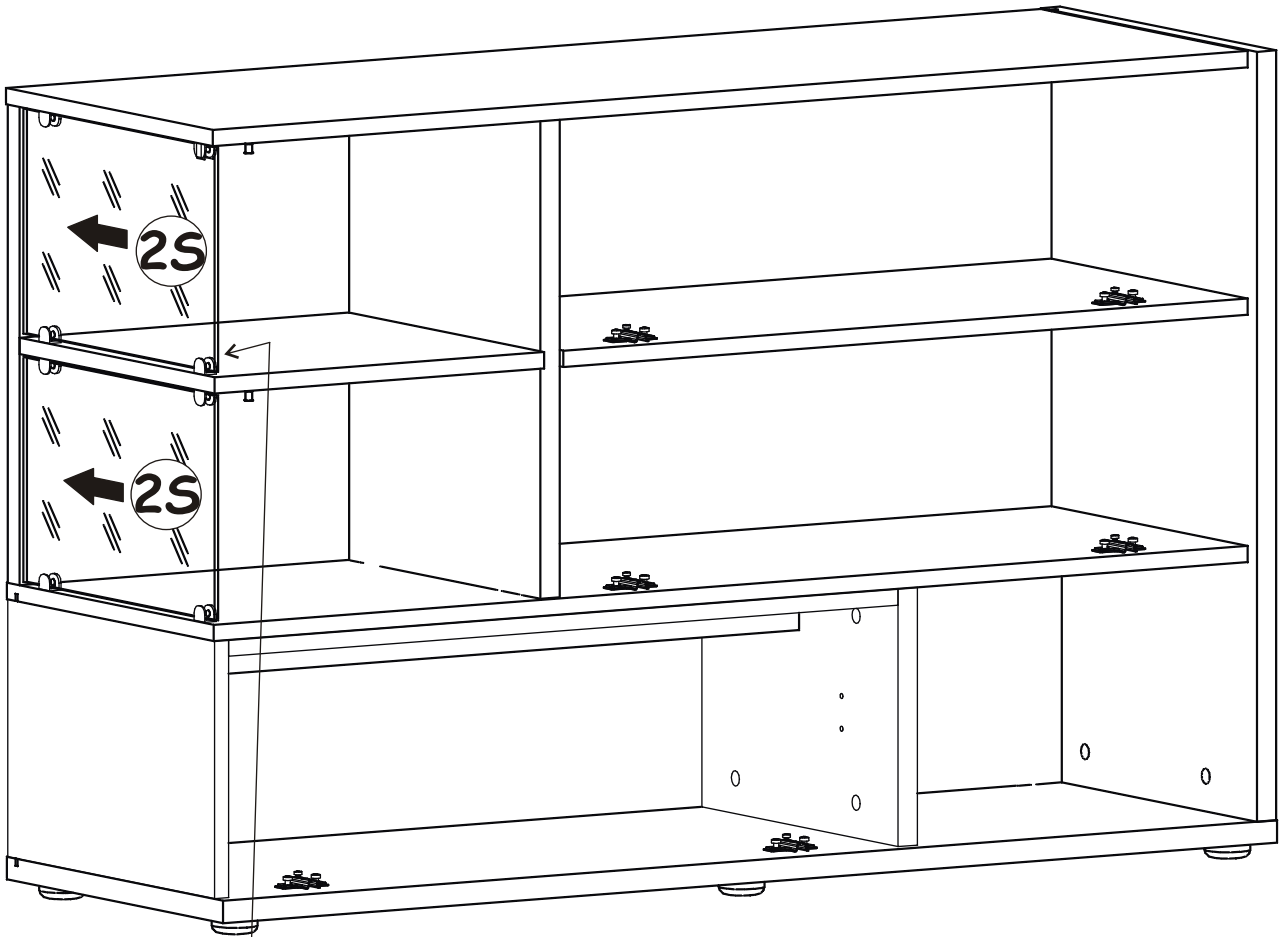

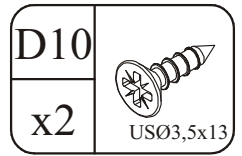
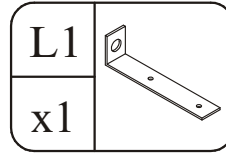
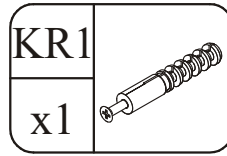

17

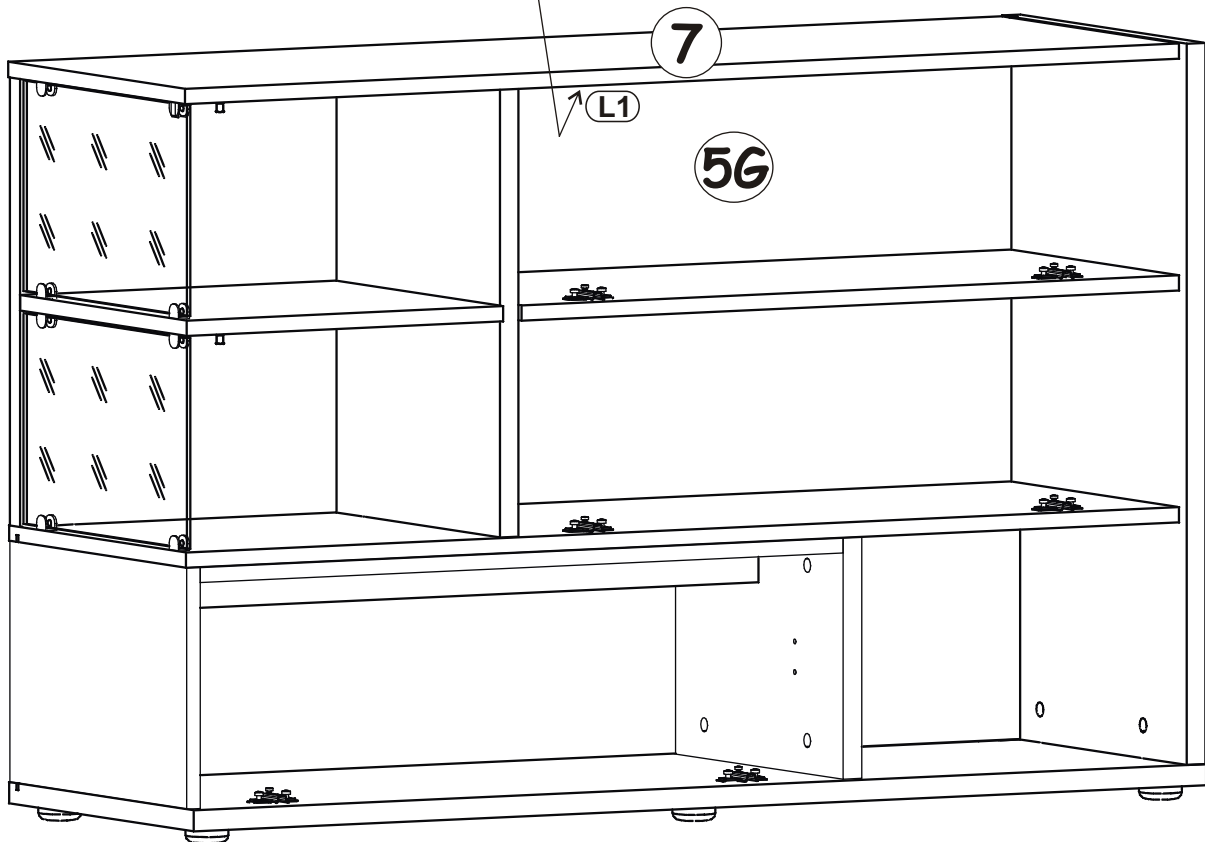
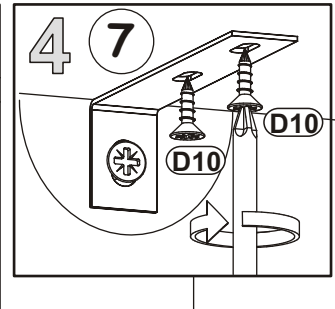
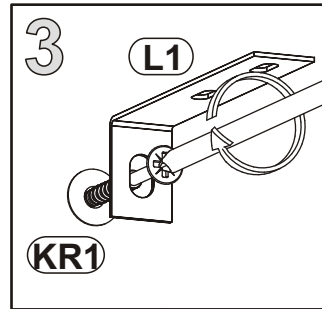
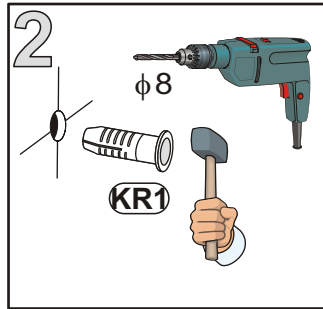
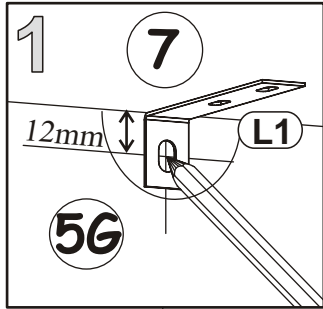
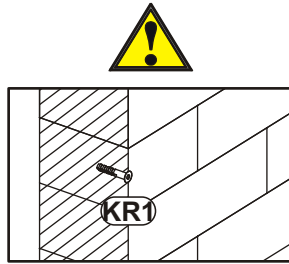
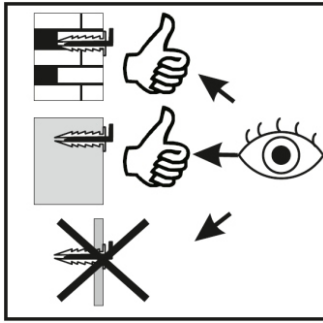

18

OD2		D10	
x3		x6	

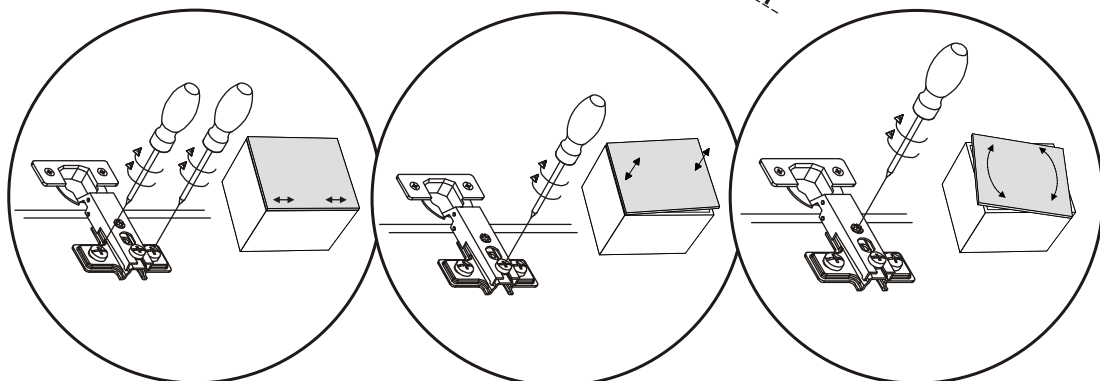
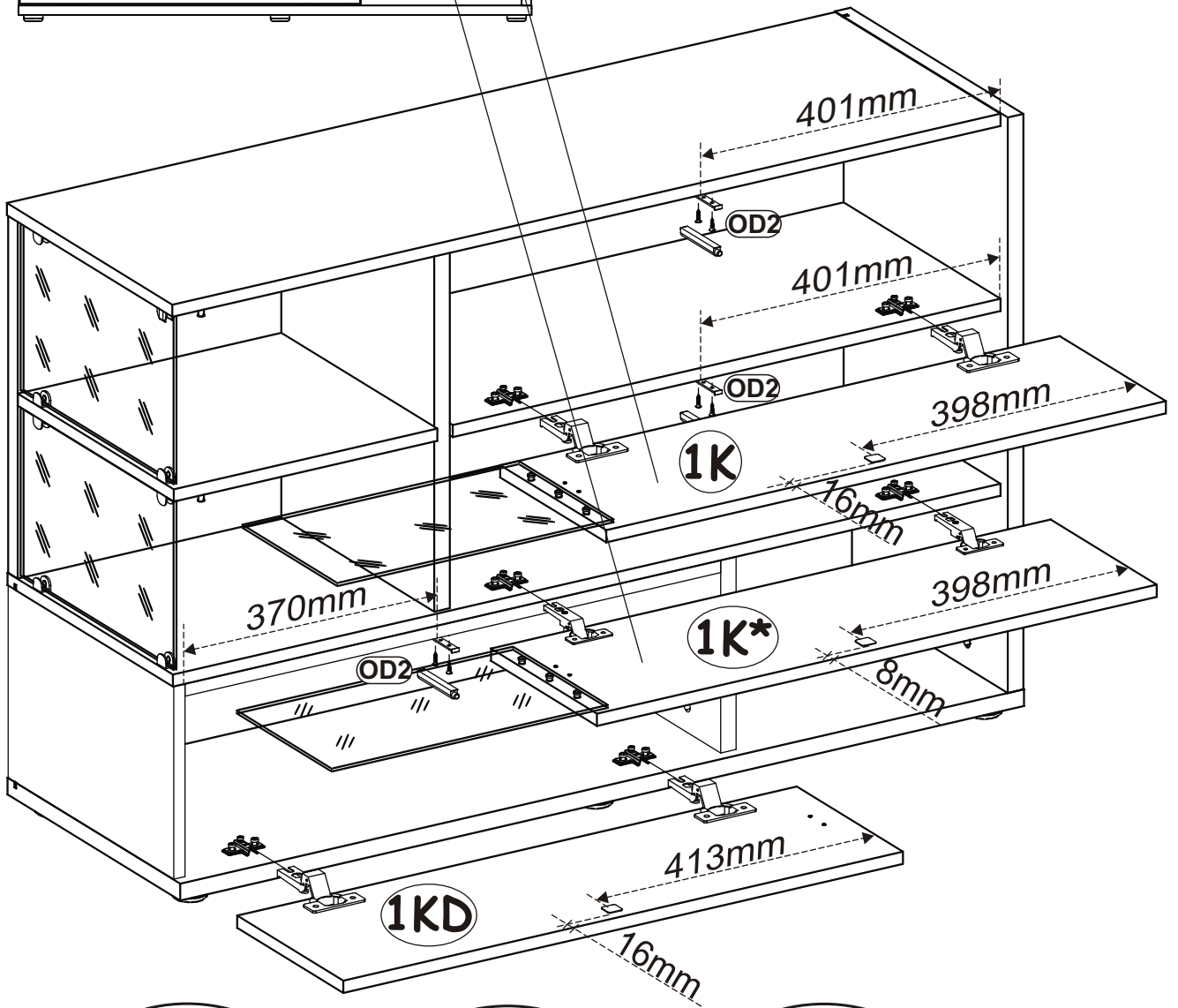
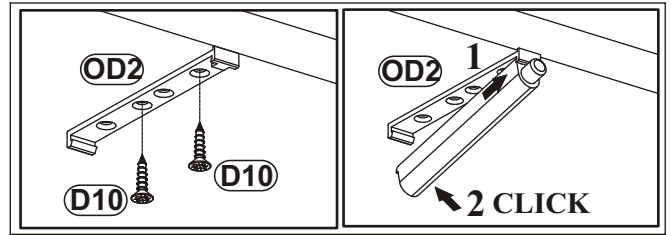
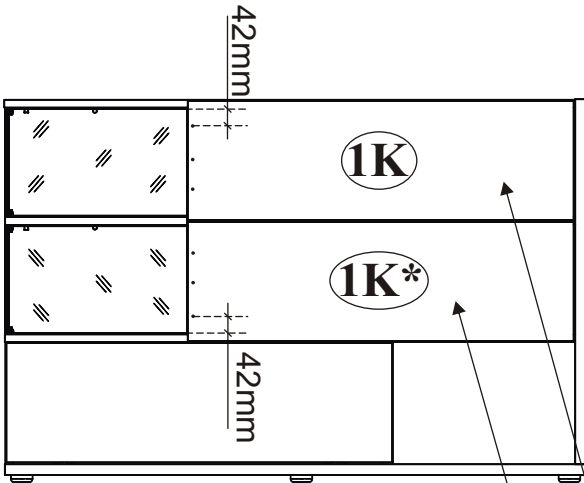

19

G21	
x3	

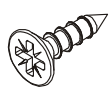
D10	
x6	USØ3,5x13

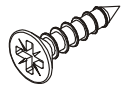
D7	
x9	USØ3x16

