

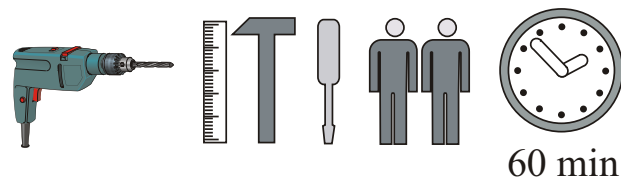

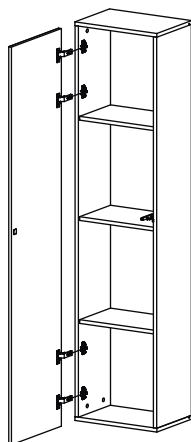

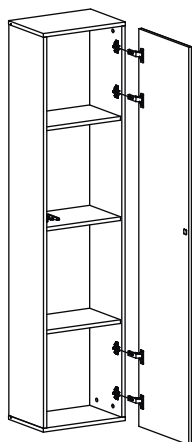

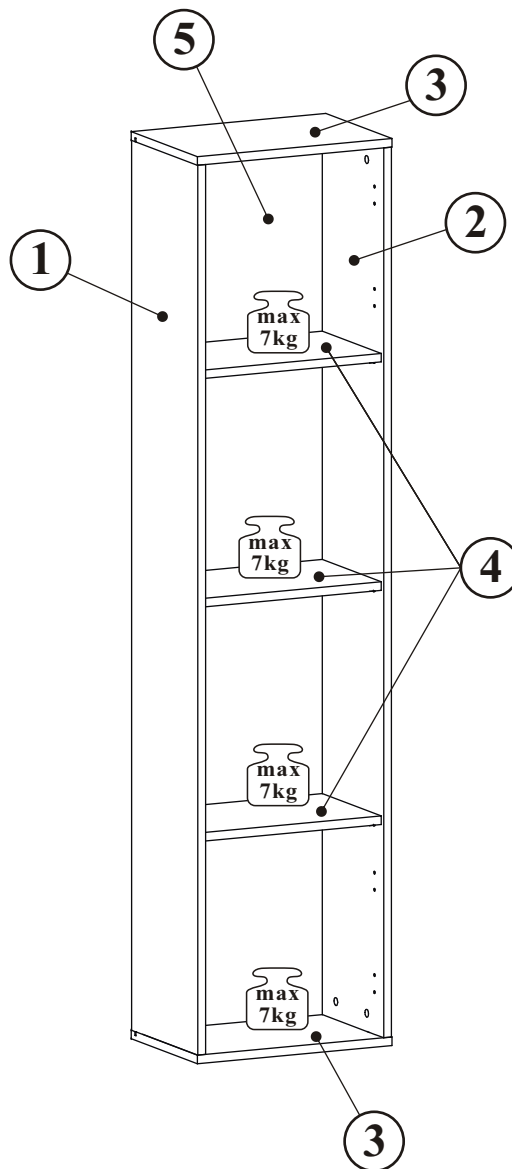

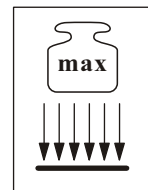
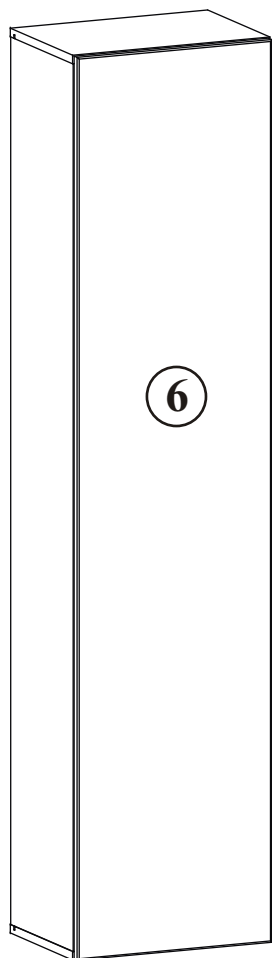
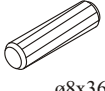
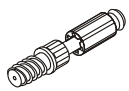

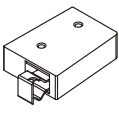
# FLY 28 -- FY 40-C

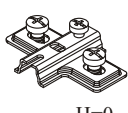
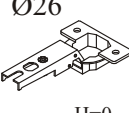

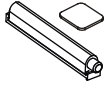
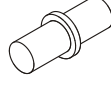

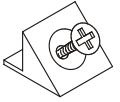
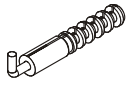
NO	Dim.		Col.-No	Qty
1	1668	274	1	1
2	1668	274	1	1
3	400	274	1	2
4	366	244	1	3
5	1680	378	1	1
6	394	1696	1	1

FLY 28--FY 40-C

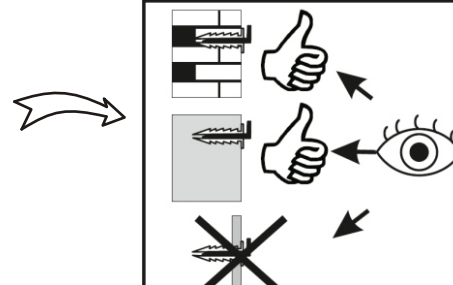
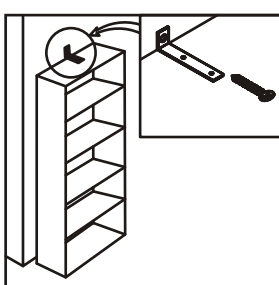
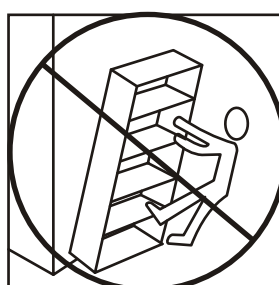
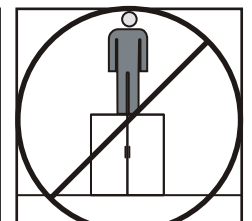
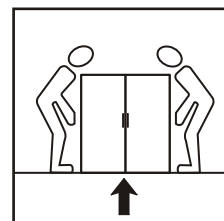
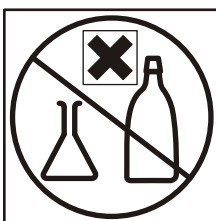
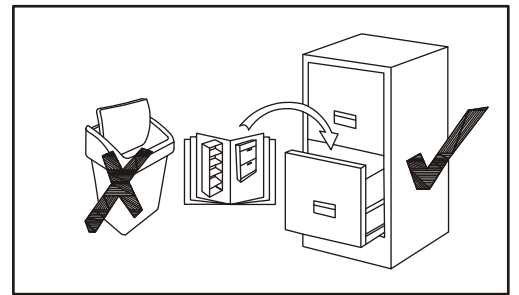
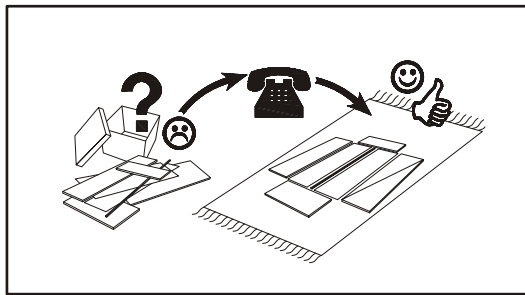
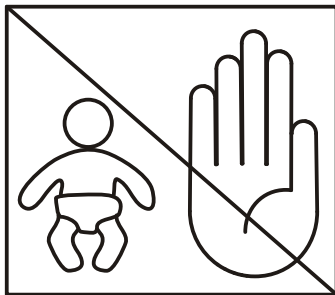
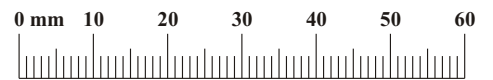
A1 x8  ø8x36	B4 x8 	B5 x8  ø15x12	G5 x8 	ZR1 x2 	D6 x4  USØ3,5x30
E2 x4  H=0	E1 x4  Ø26 H=0	D10 x10  USØ3,5x13	AM x1 	G7 x12 	Z2 x8  Ø5
S1 x12 	KR2 x2 	G2 x1 			

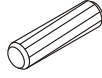

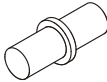
A1		B5		G7	
x8	ø8x36	x8	ø15x12	x12	

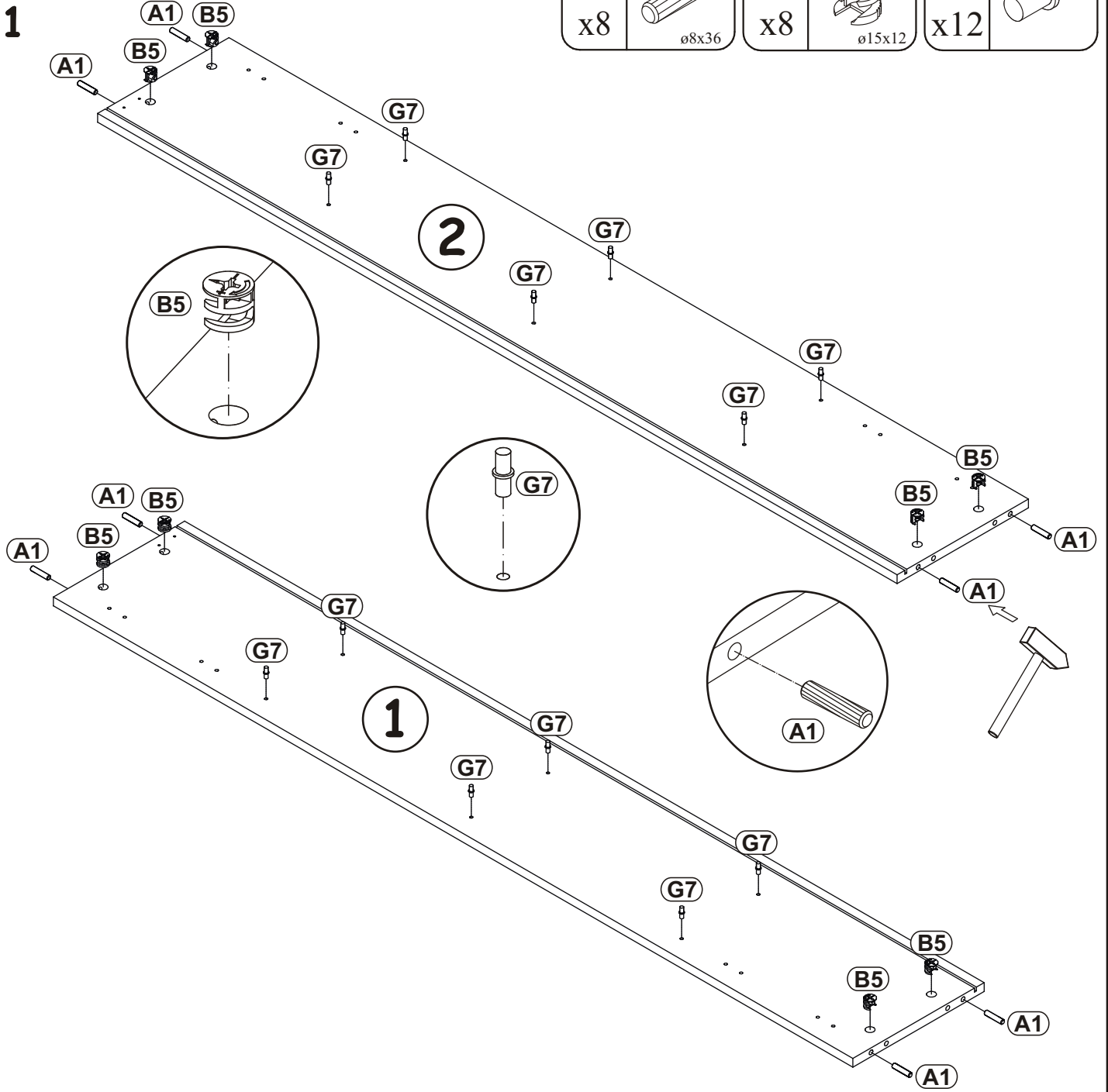

**2**

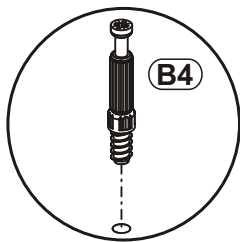

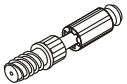
B4	
x8	

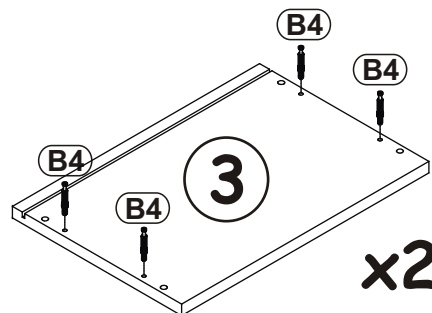

FLY 28--FY 40-C

3

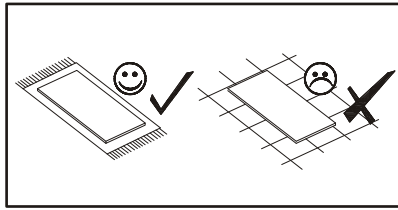

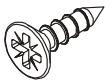

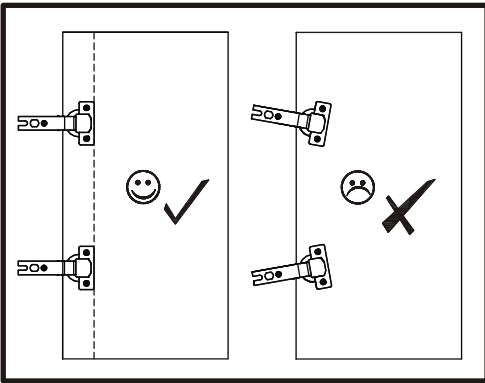
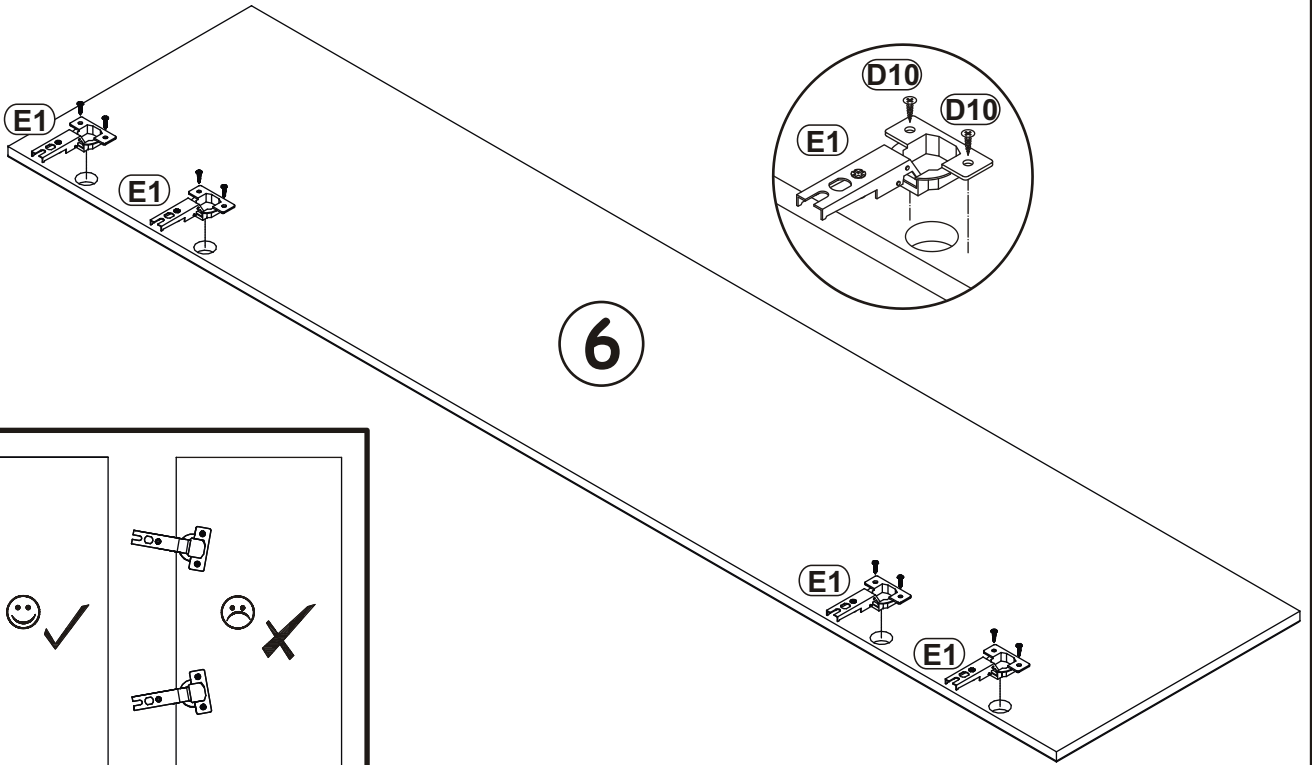
E1	Ø26	D10	 USØ3,5x13
x4	H=0	x8	

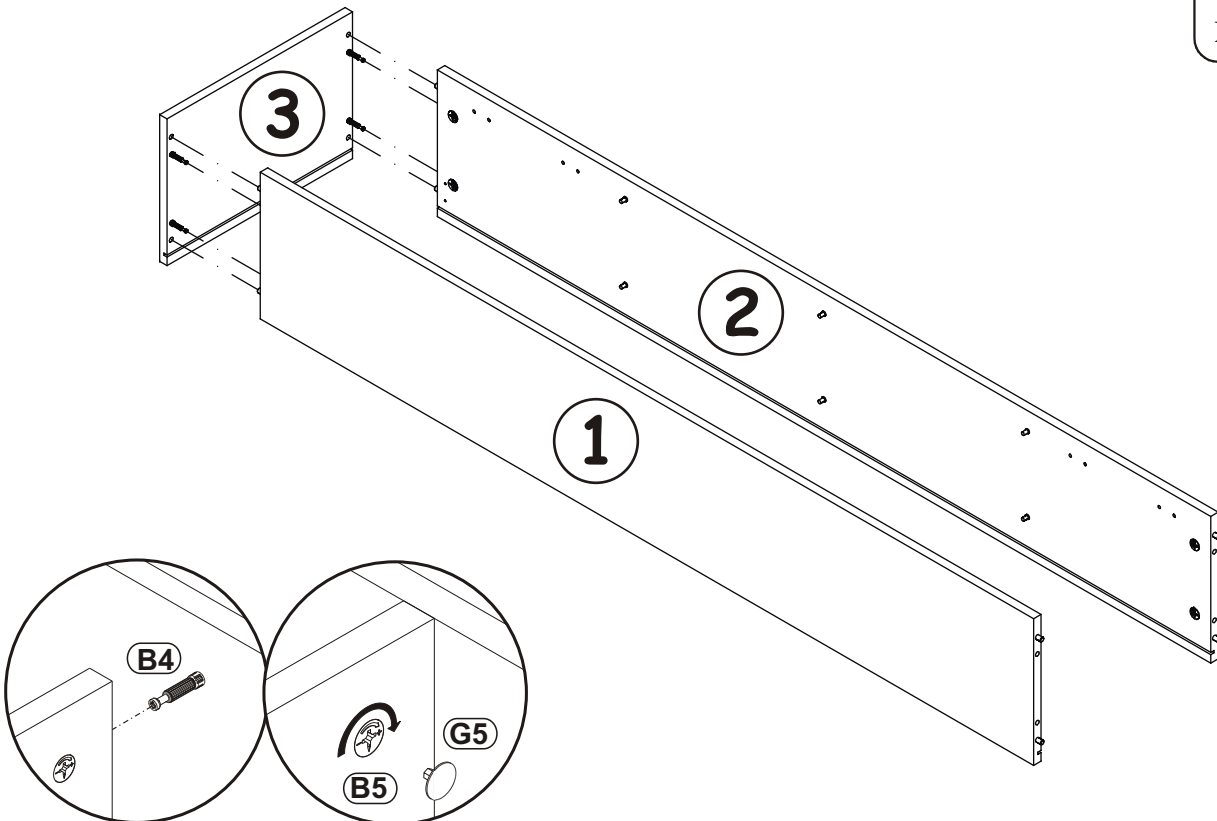

4

G5	
x4	



G5	
x4	

5

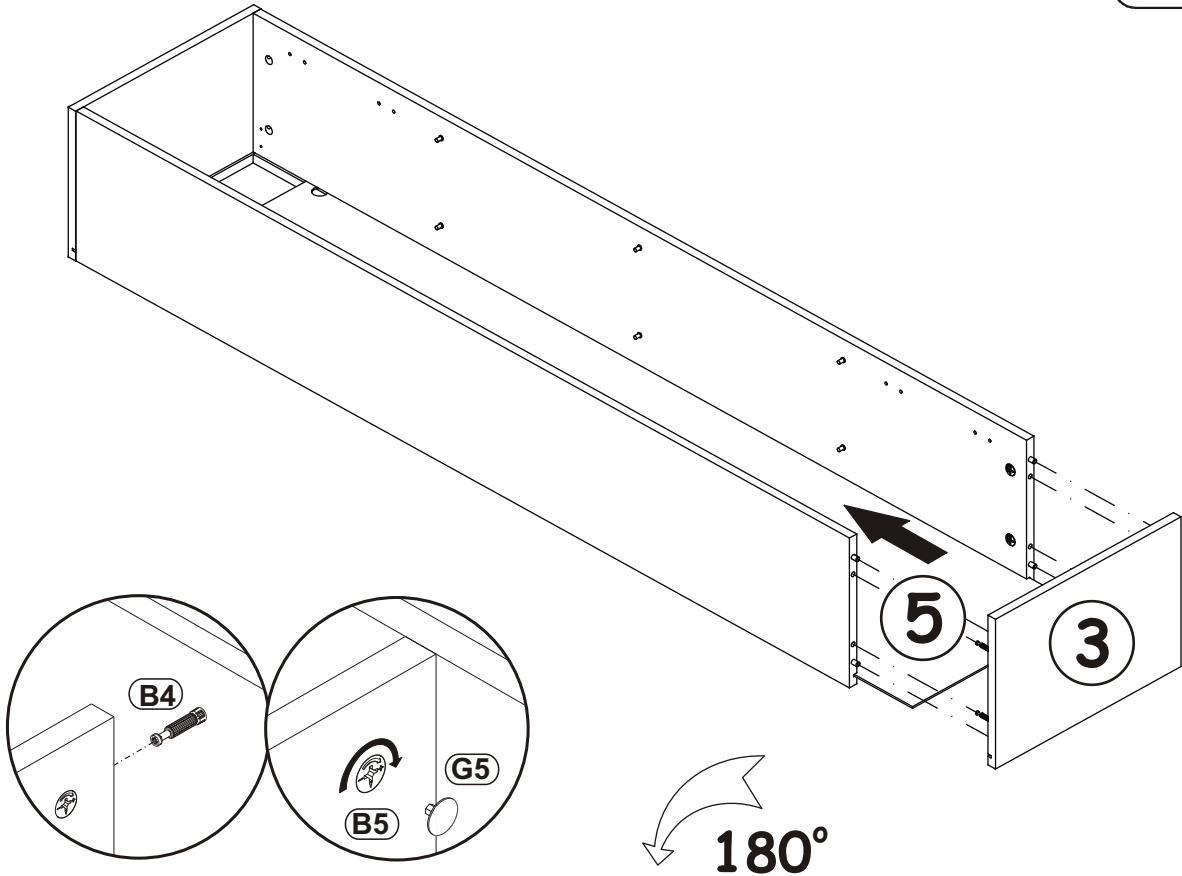

6

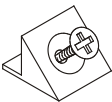

S1	
x12	

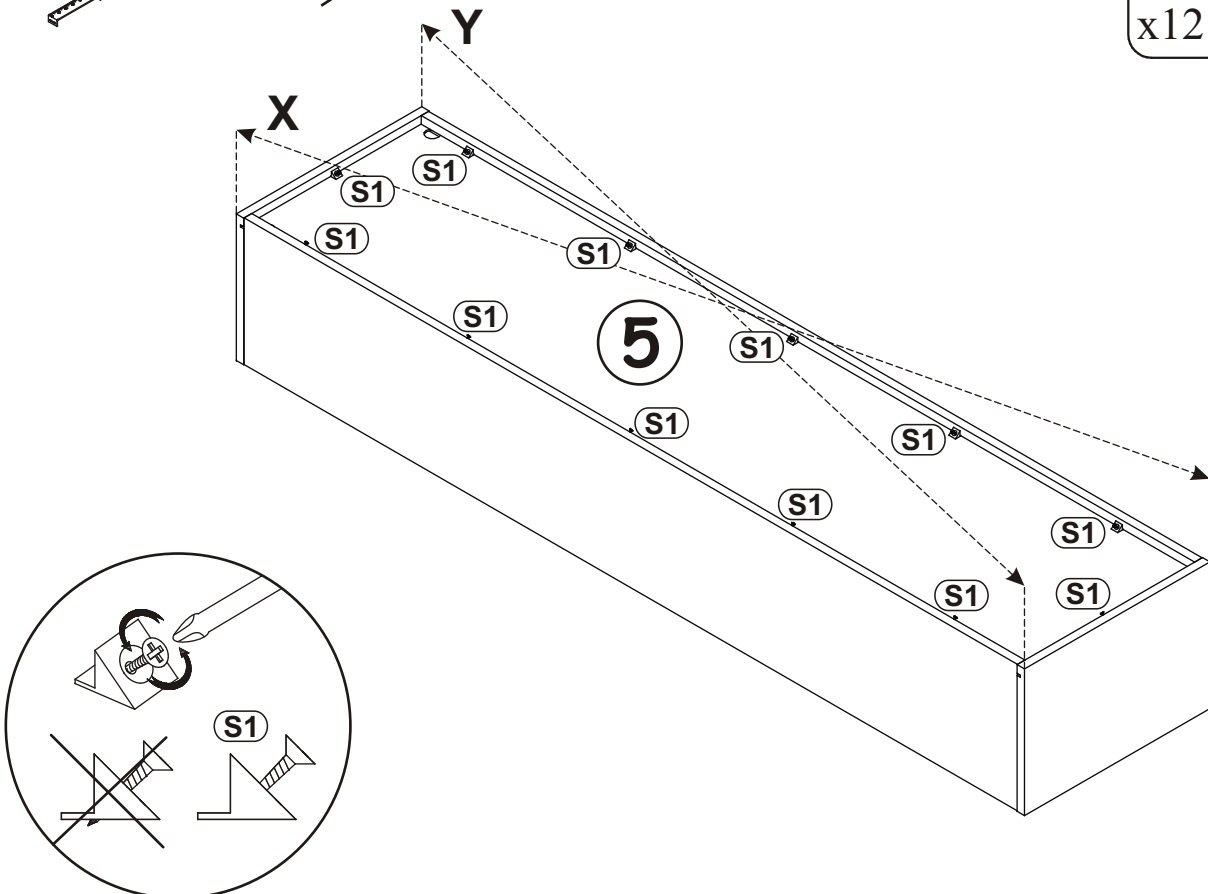

FLY 28--FY 40-C

7

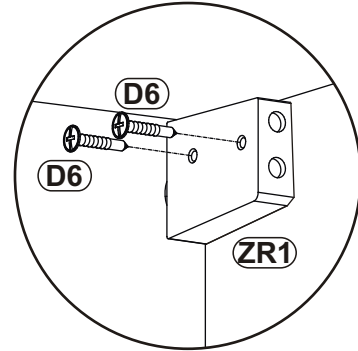
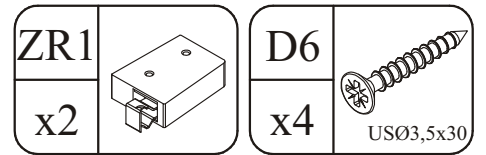
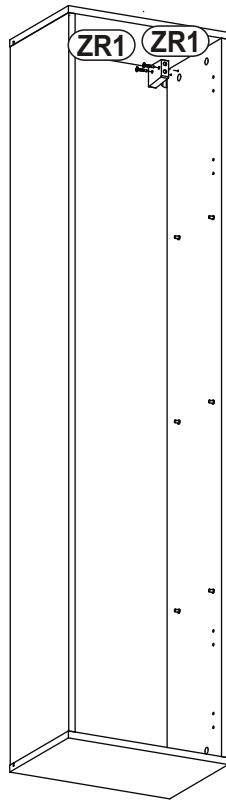
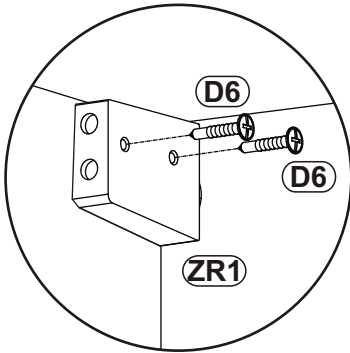

8

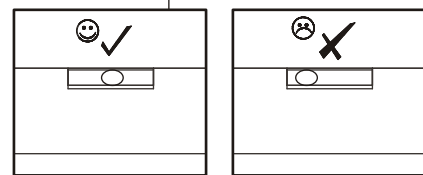
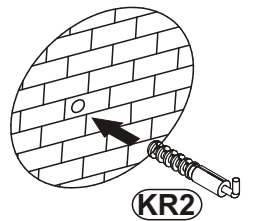
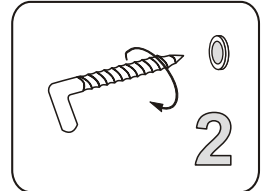
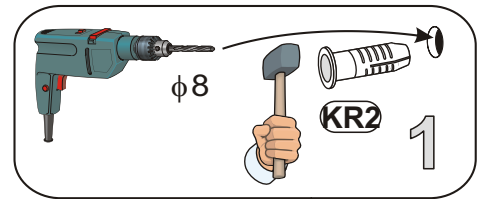
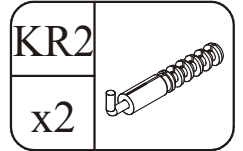
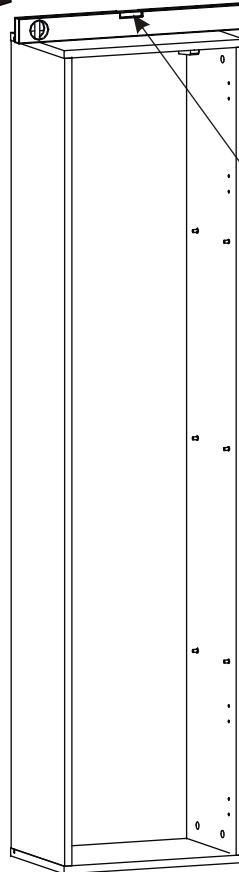
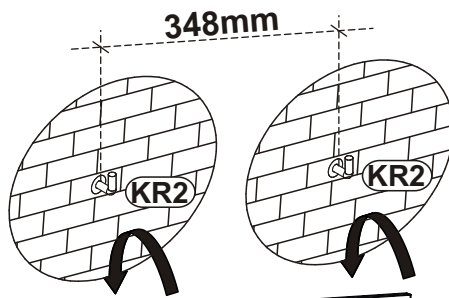
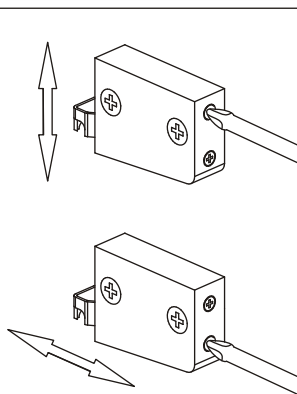
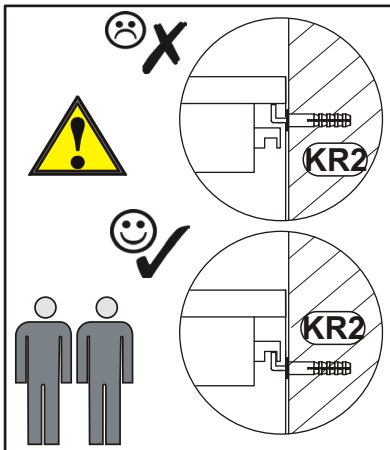
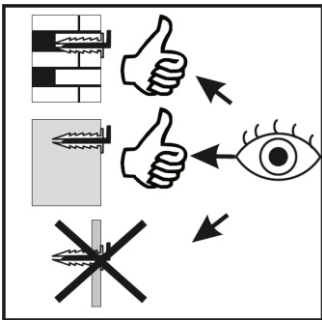

**9-10**

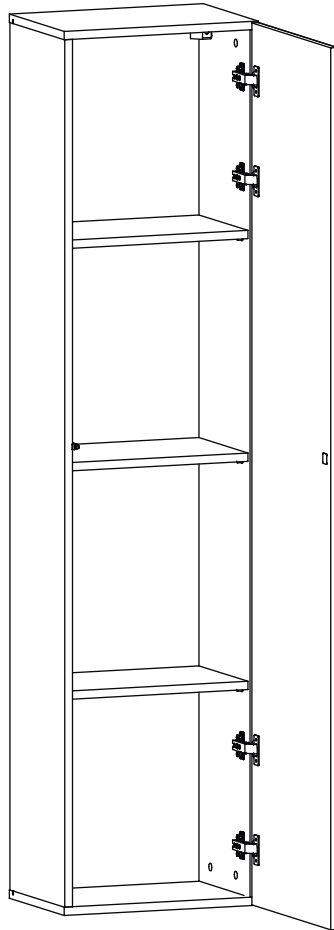

**11-12**

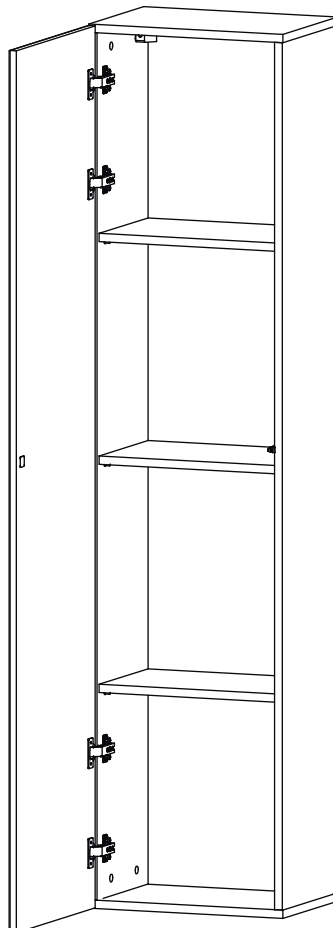

9

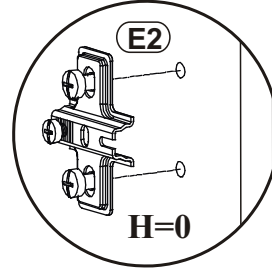
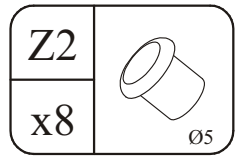
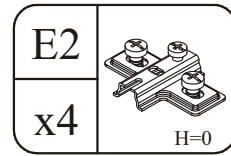
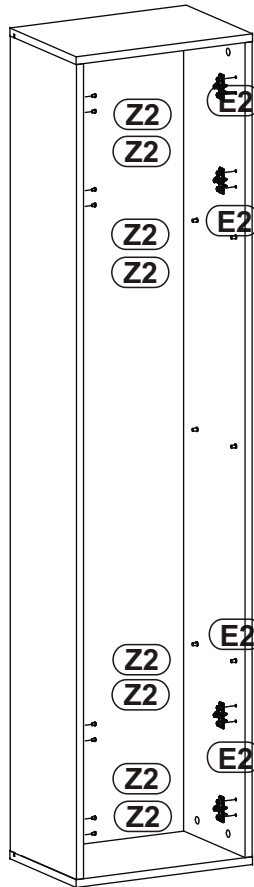
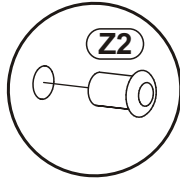
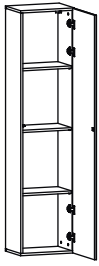

10

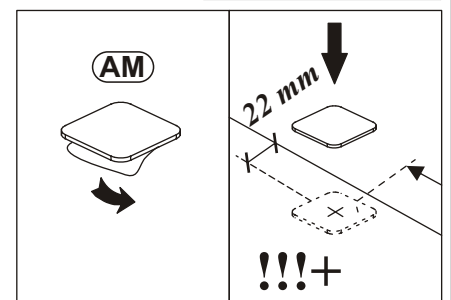
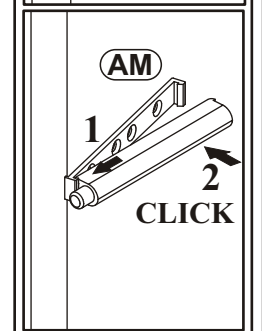
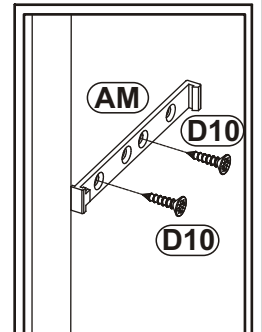
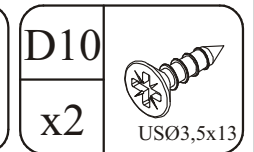
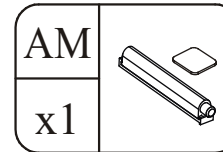
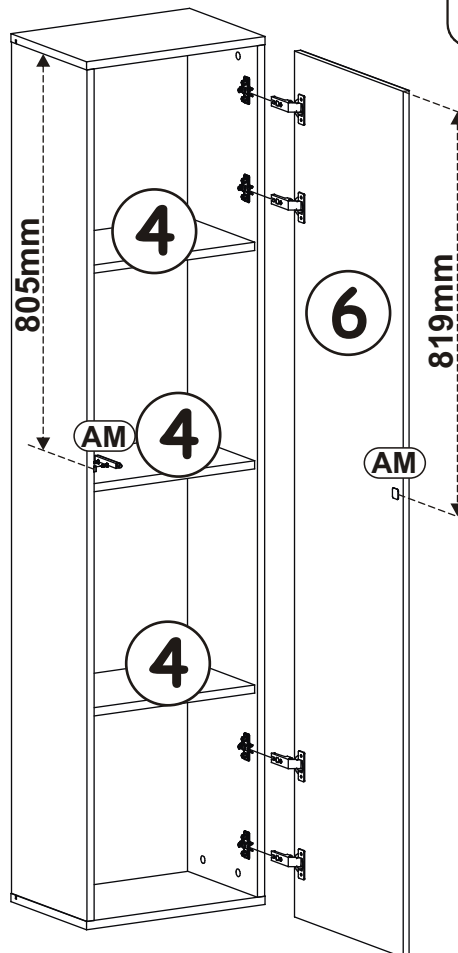
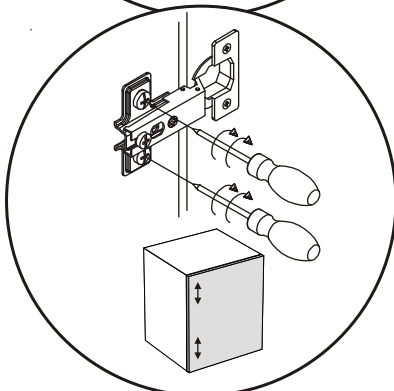
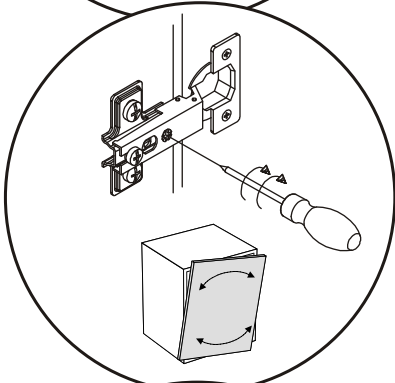
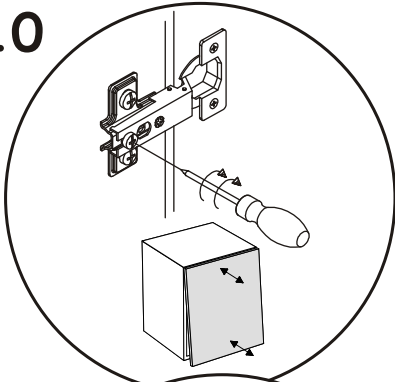



11

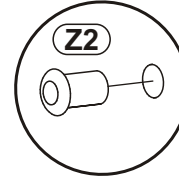
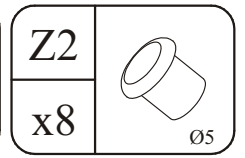
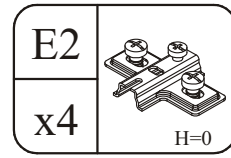
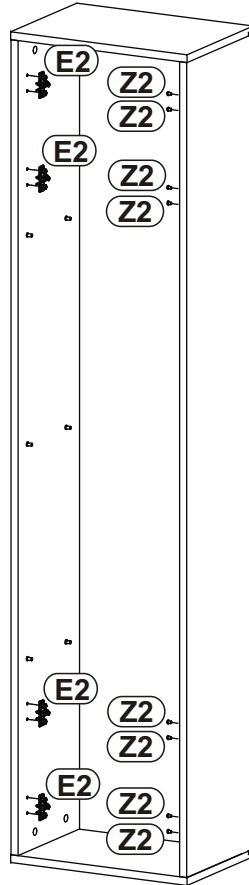
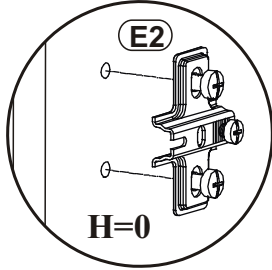
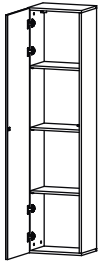

12

