

LIAM-__LM PW

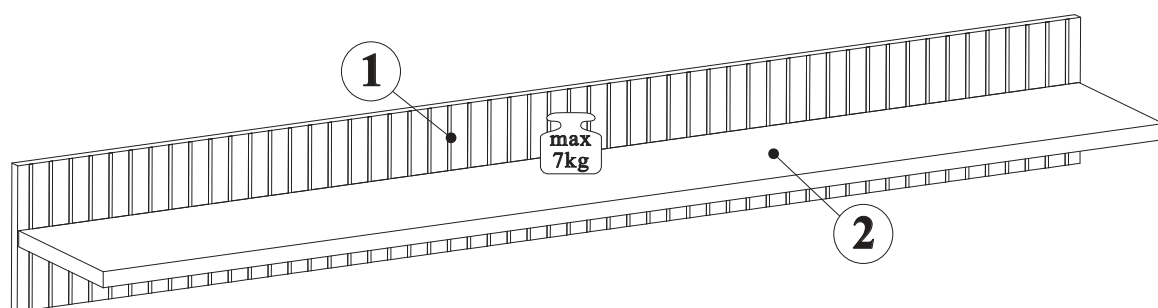

NO	Dim (mm)			Col.-No	Qty
1	1600	200	16	1/1	1
2	1596	234	22	1/1	1

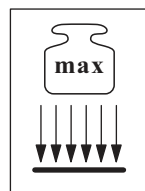
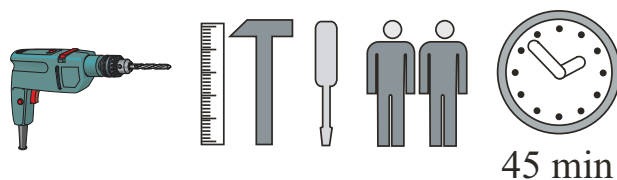

45 min

LIAM-__LM PW

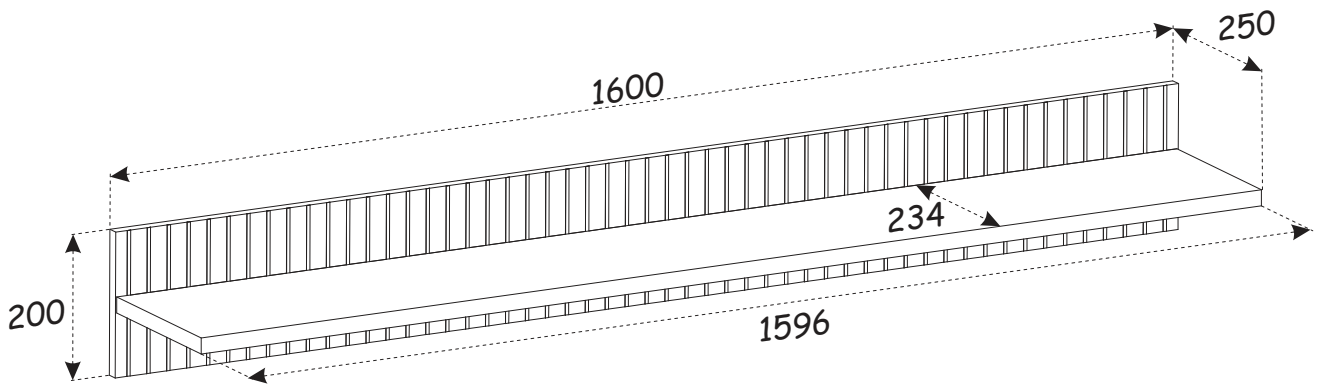

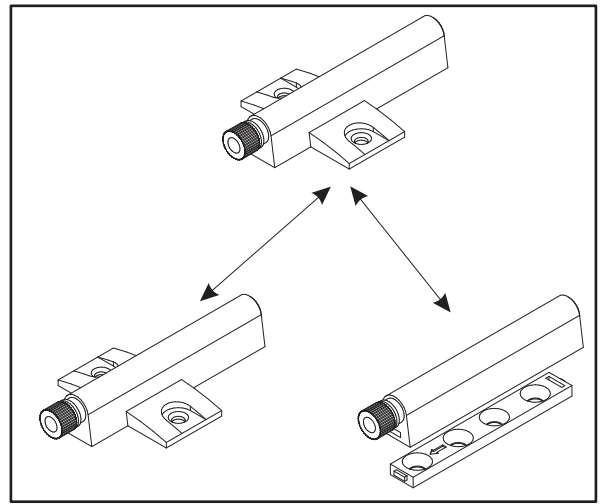
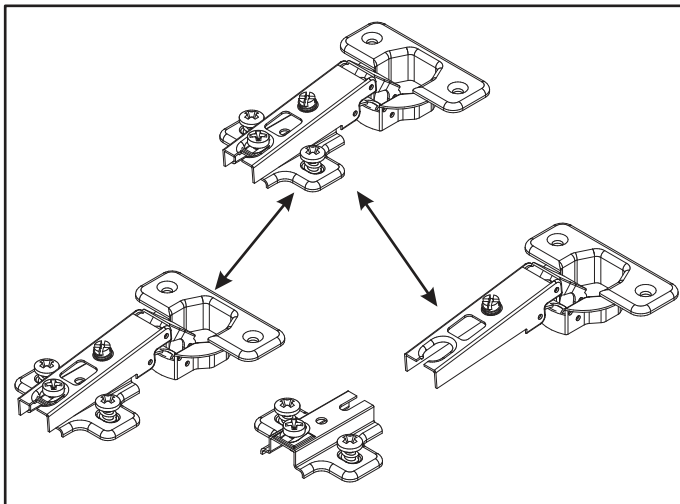
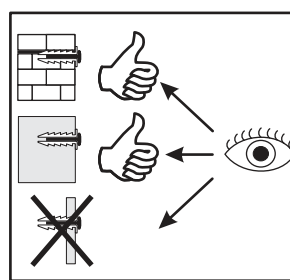
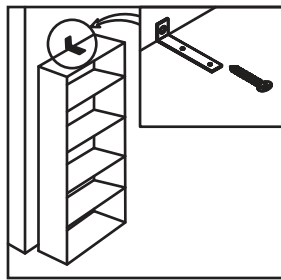
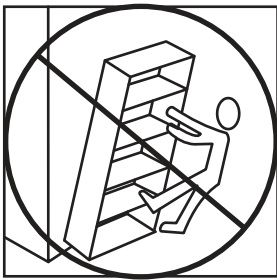
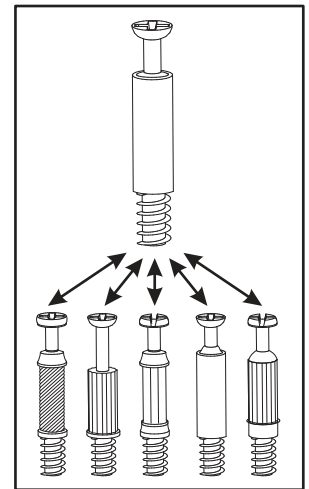
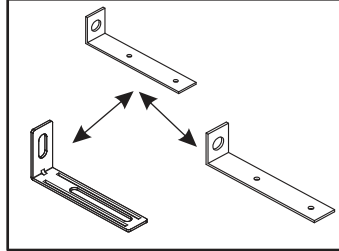
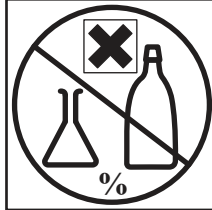
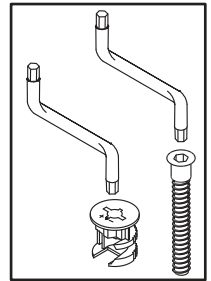
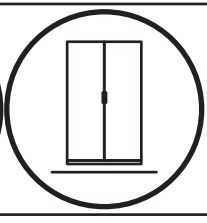
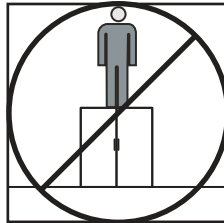
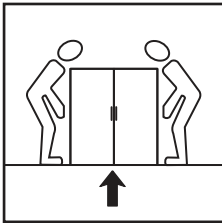
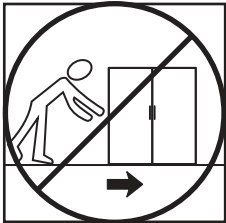
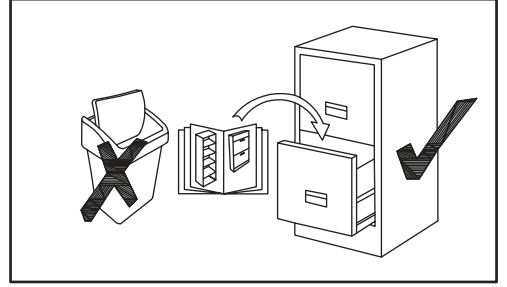
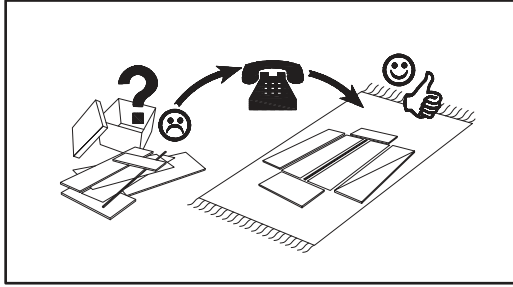
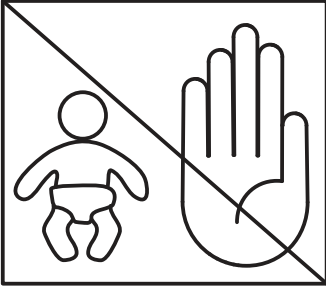
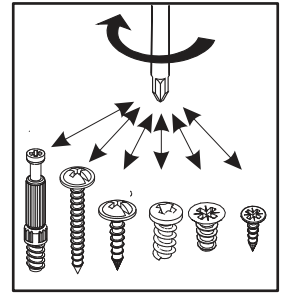
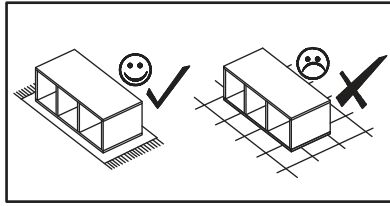
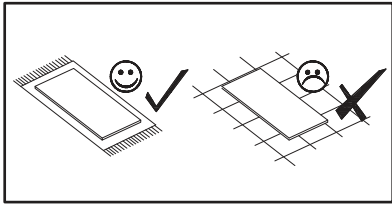

LIAM-__LM PW

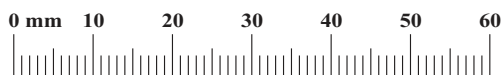
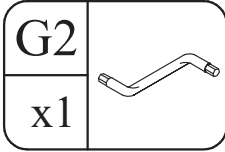
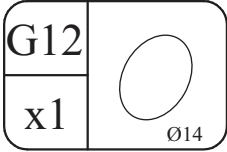
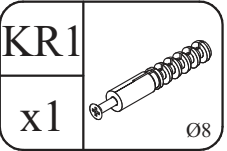
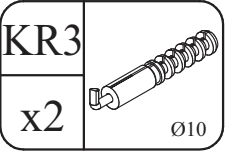
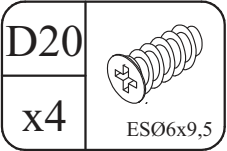
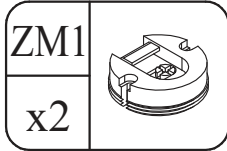
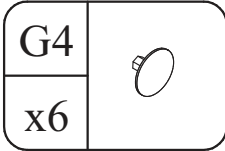
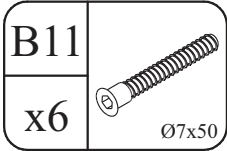

LIAM-__LM PW

ZM1		D20	
x2		x4	ESØ6x9,5

1

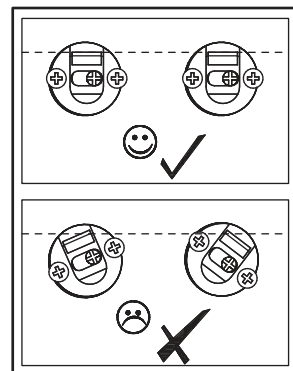
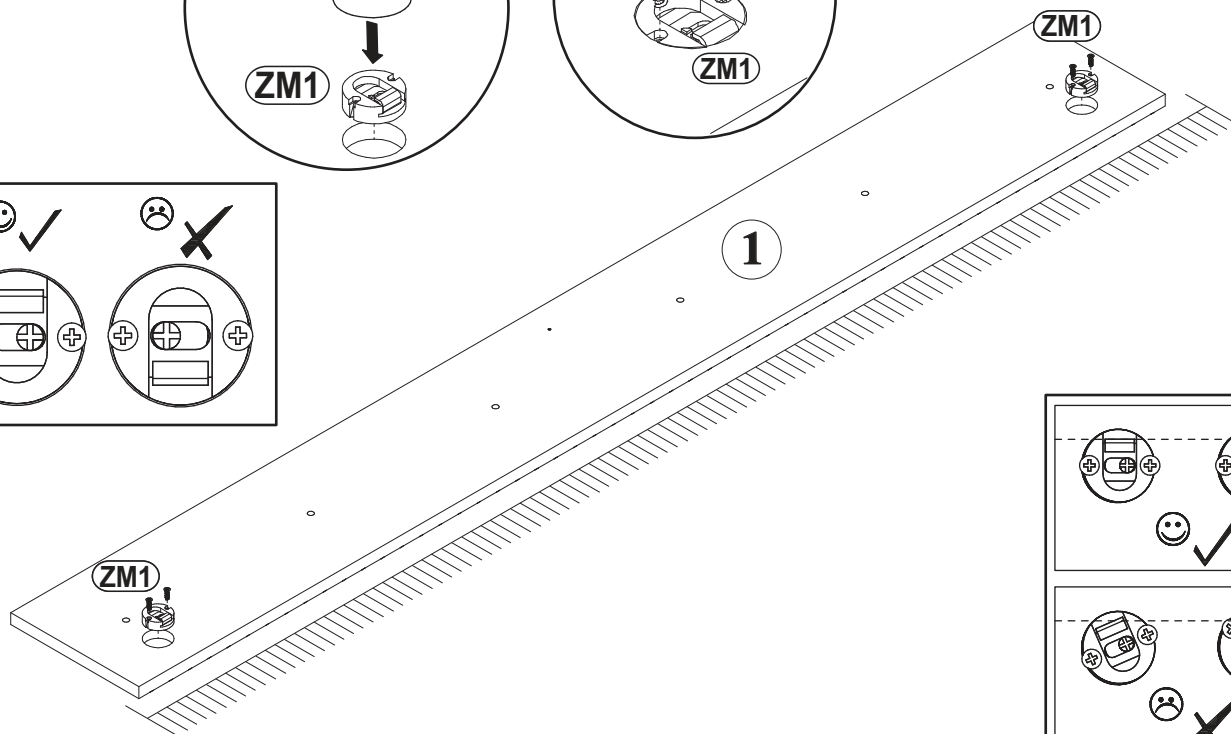
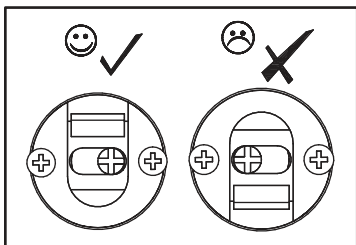
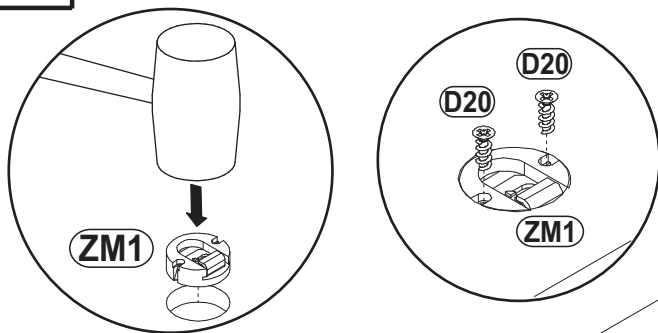

2

B11		G4	
x6	Ø7x50	x6	

G2	
x1	

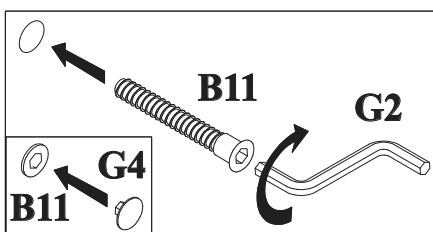
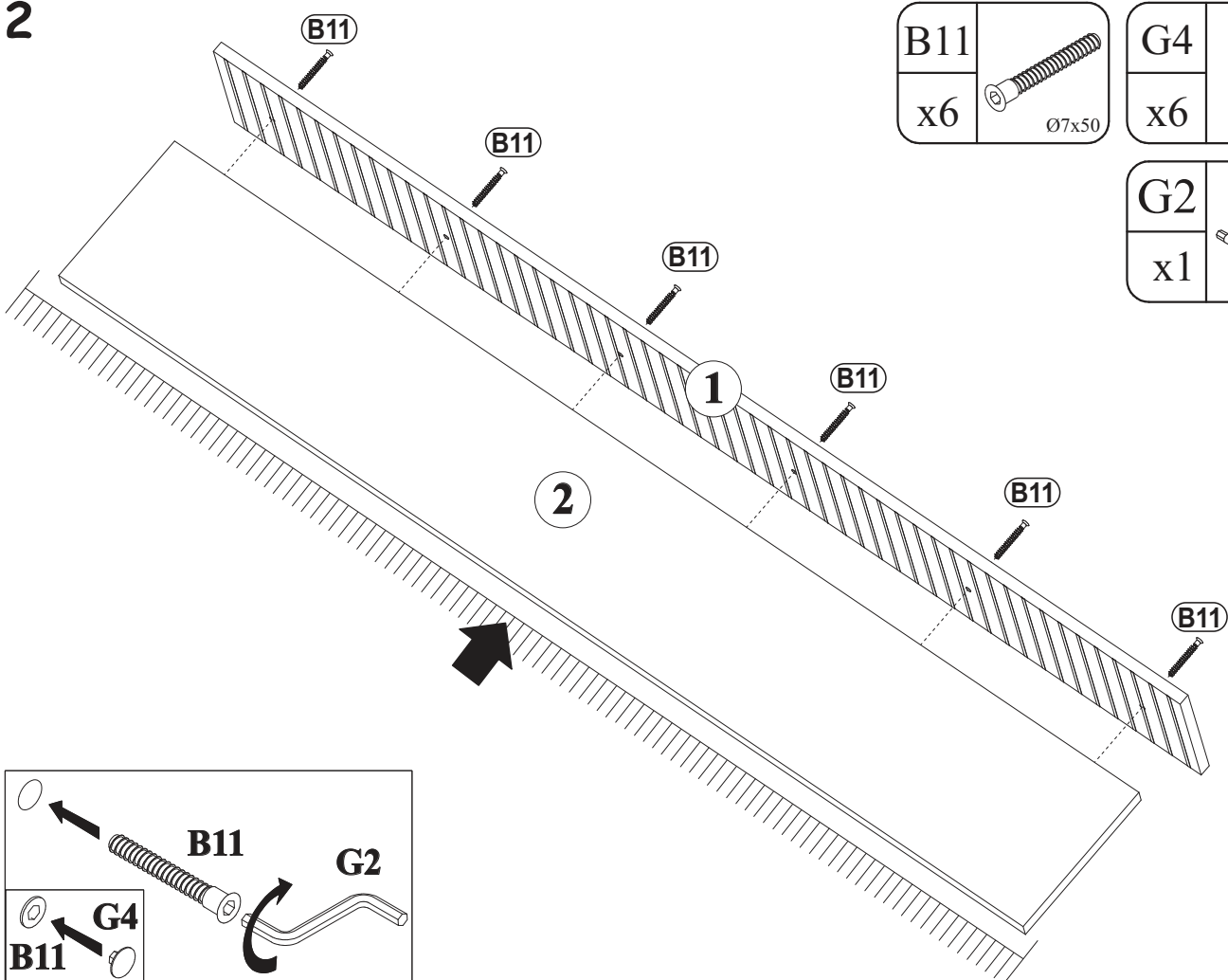

3

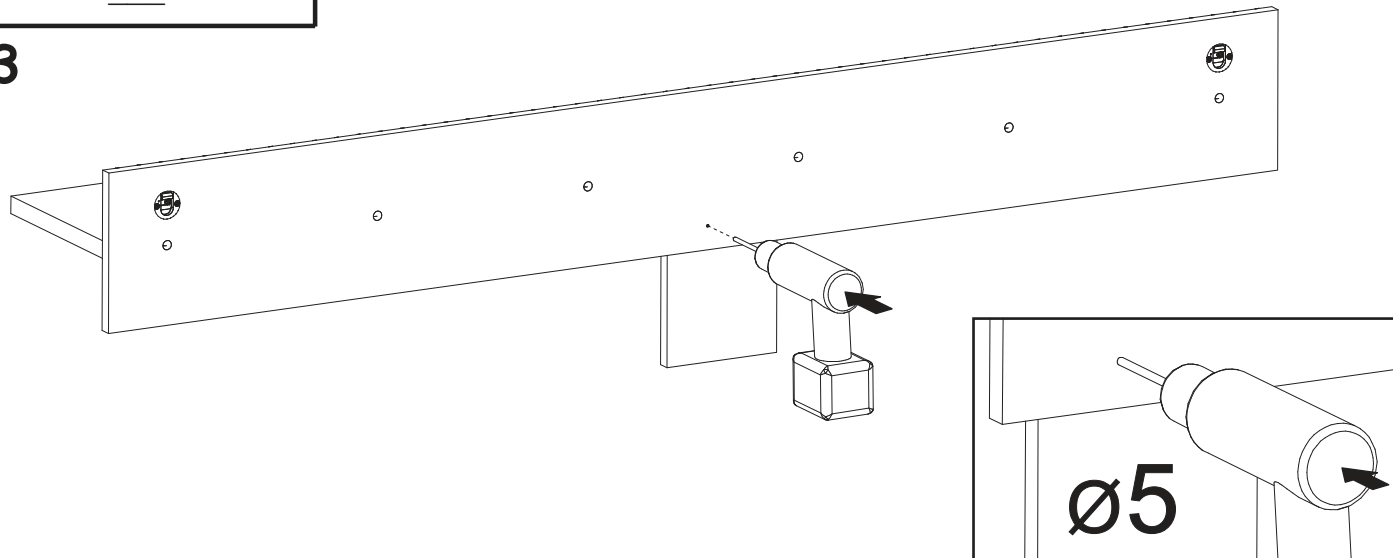

4

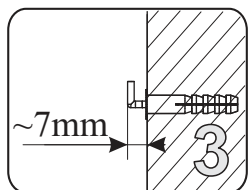
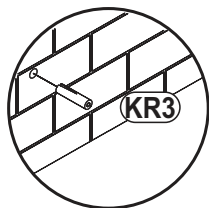
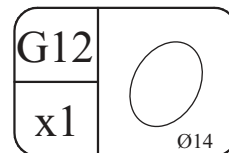
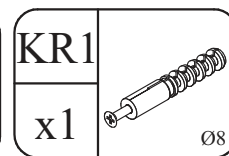
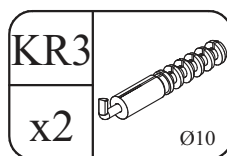
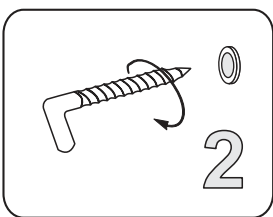
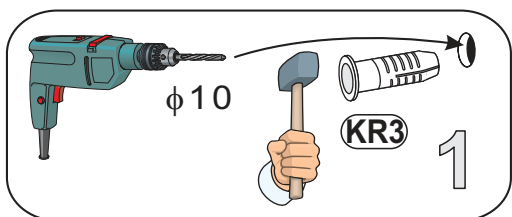

1440

