

LIAM-__LM RTV

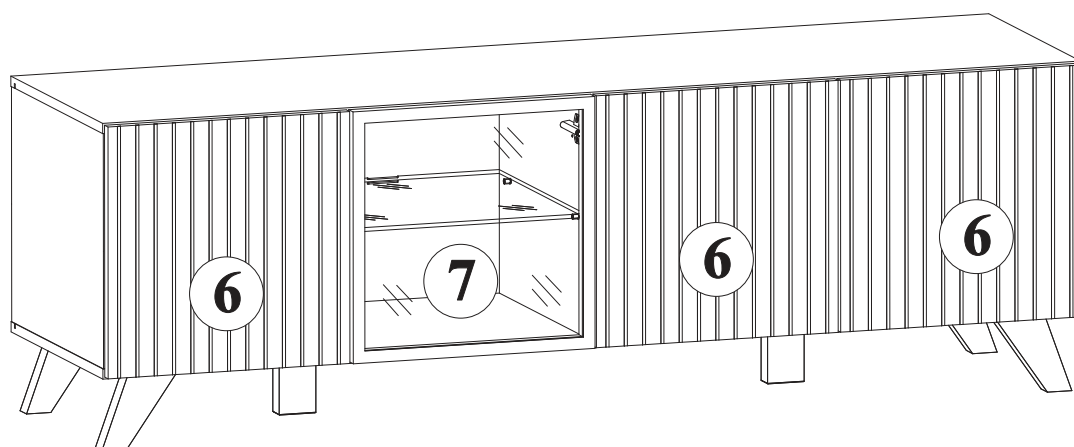

NO	DIM [mm]		COL.-NO	QTY
1	1602	430	16 2/2	1
2	1602	430	16 2/2	1
3	370	430	16 1/2	2
4	370	410	16 1/2	2
5	370	410	16 1/2	2
6	396	396	16 1/2	3
7	396	396	21 1/2	1
8	1580	382	3 2/2	1
9	400	383	6 1/2	1

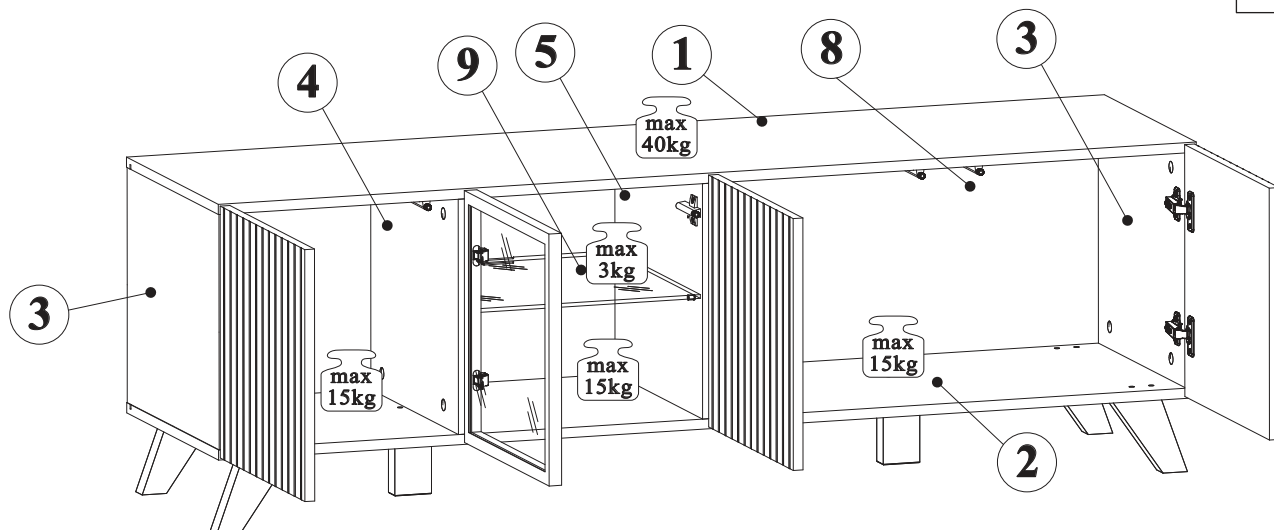

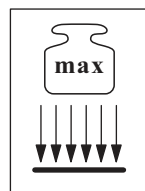
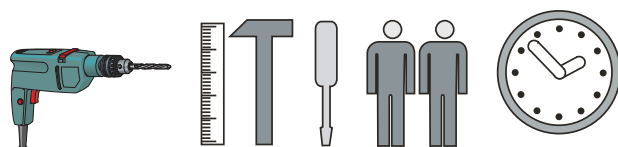



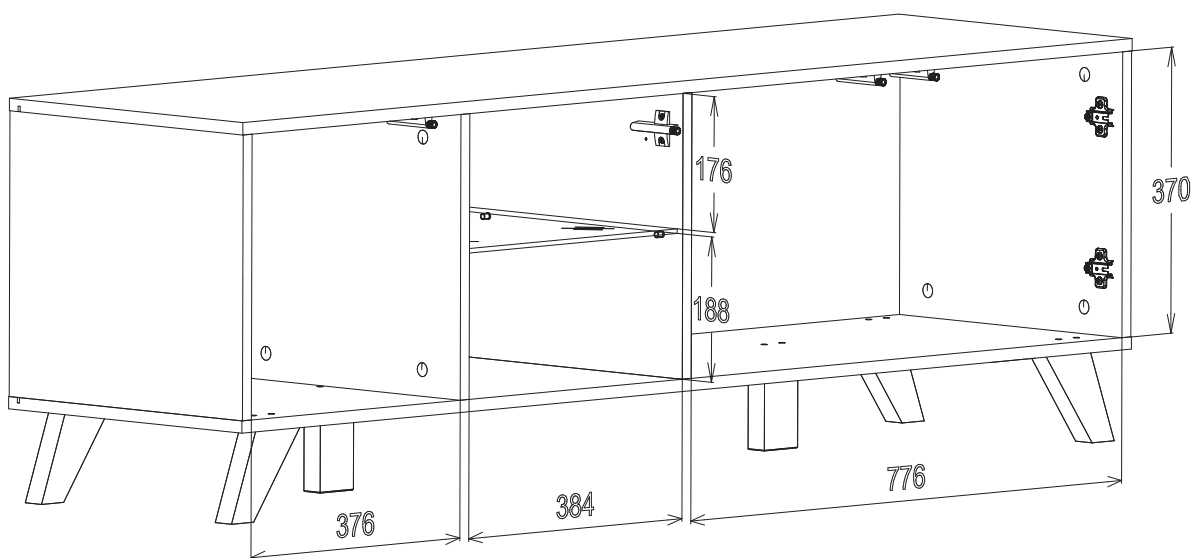
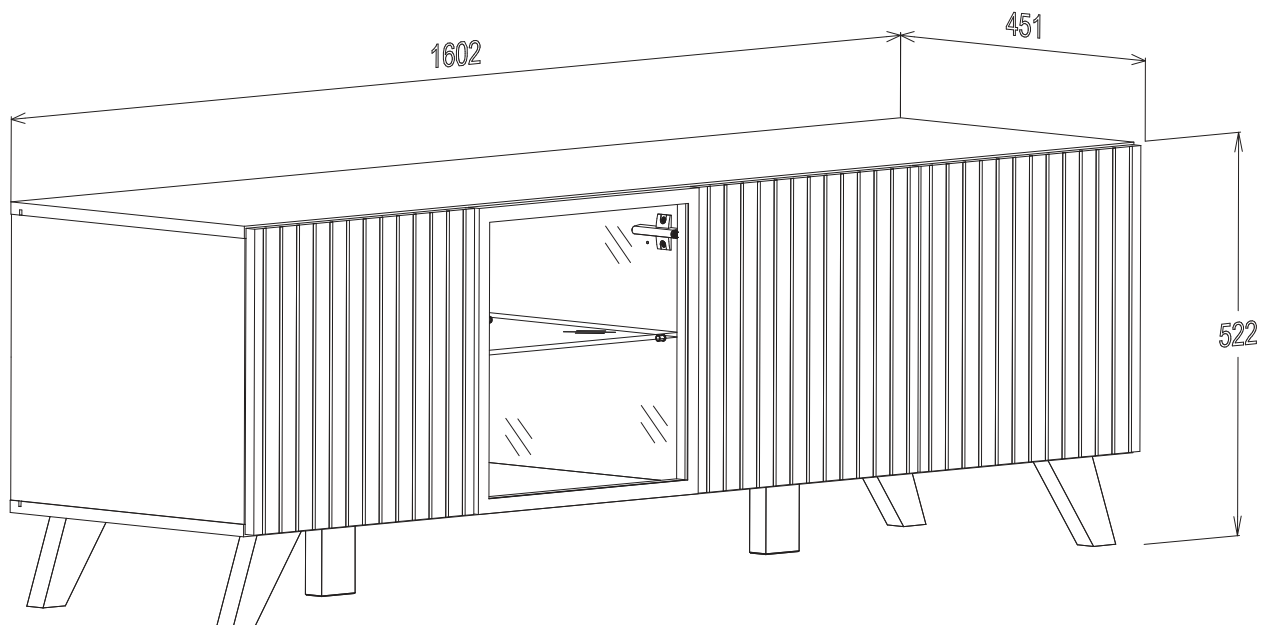

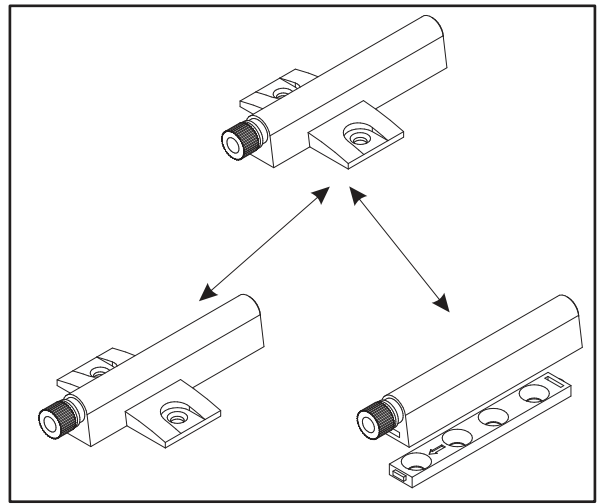
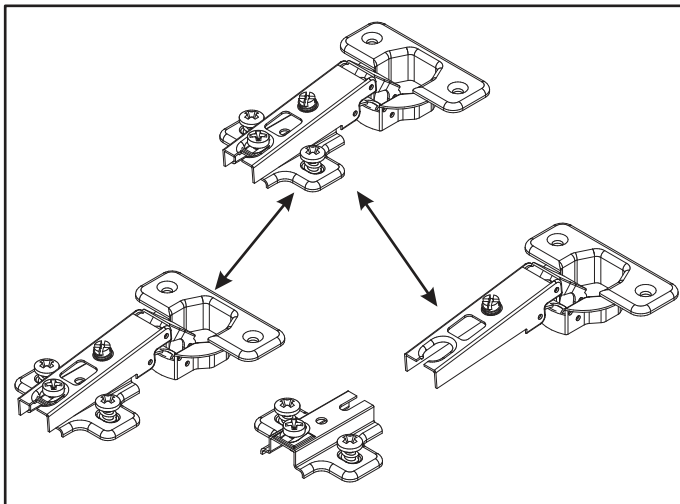
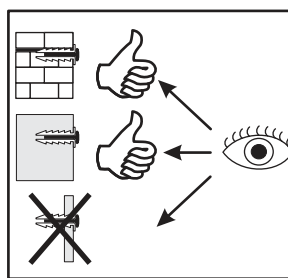
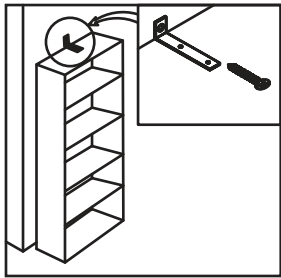
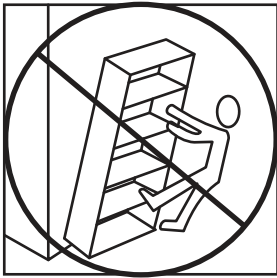
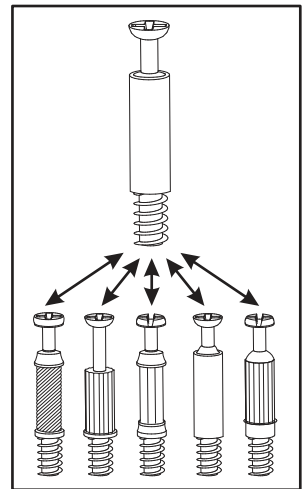
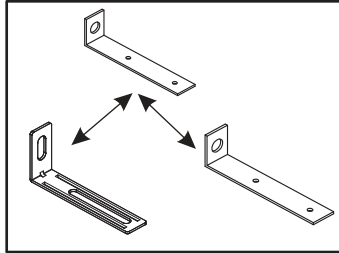
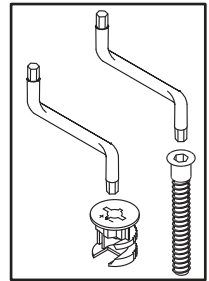
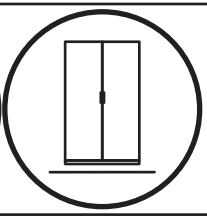
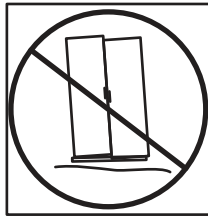
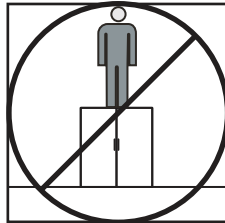
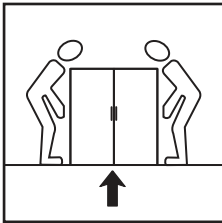
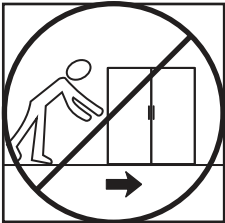
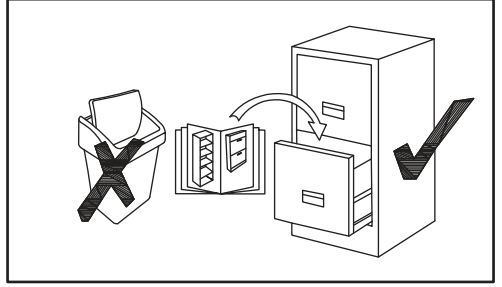
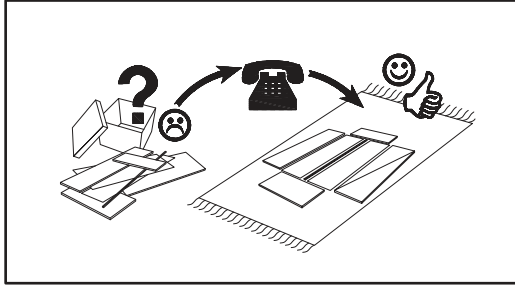
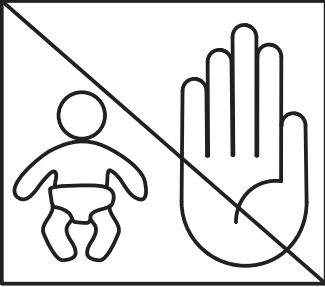
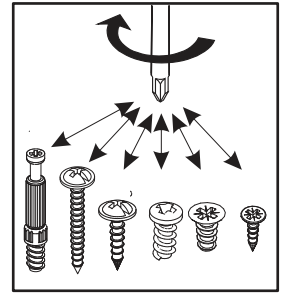
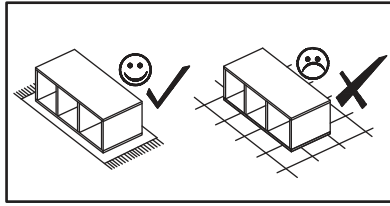
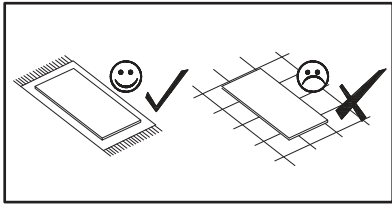

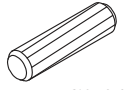

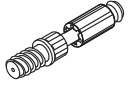
200 min

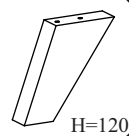
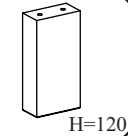
LIAM-__LM RTV

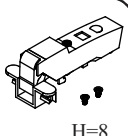
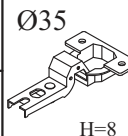
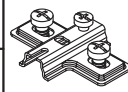
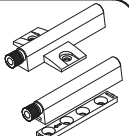
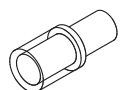

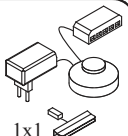
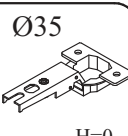
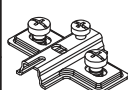
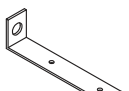

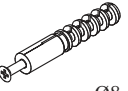

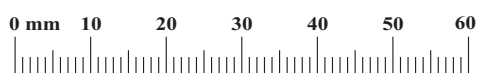
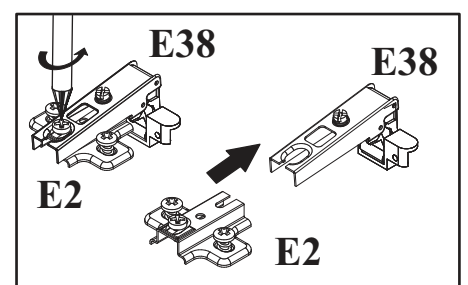
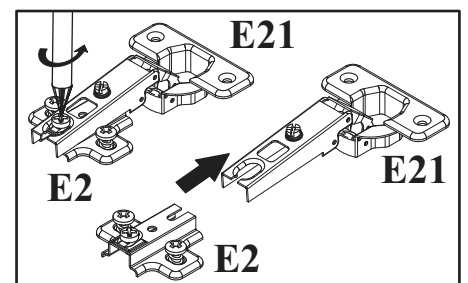
A1 x16  Ø8x36	B11 x12  Ø7x50	G4 x12 	B4 x16 	B5 x16  Ø15x12	G5 x16 
SK x4  H=120	SP x2  H=120	D10 x24  USØ3,5x13	E31 x2  H=8	E23 x2  Ø35 H=8	E4 x4  H=2
T3/T5 x4 	G20 x4 	S1 x12 	LED x1  1x1	E21 x4  Ø35 H=0	E2 x4  H=0
L1 x2 	G2 x1 	UP13 x6  UPØ3x16	KR1 x2  Ø8		

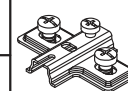

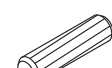
E2	
x4	H=0

A1	
x8	ø8x36

B5	
x8	Ø15x12

1

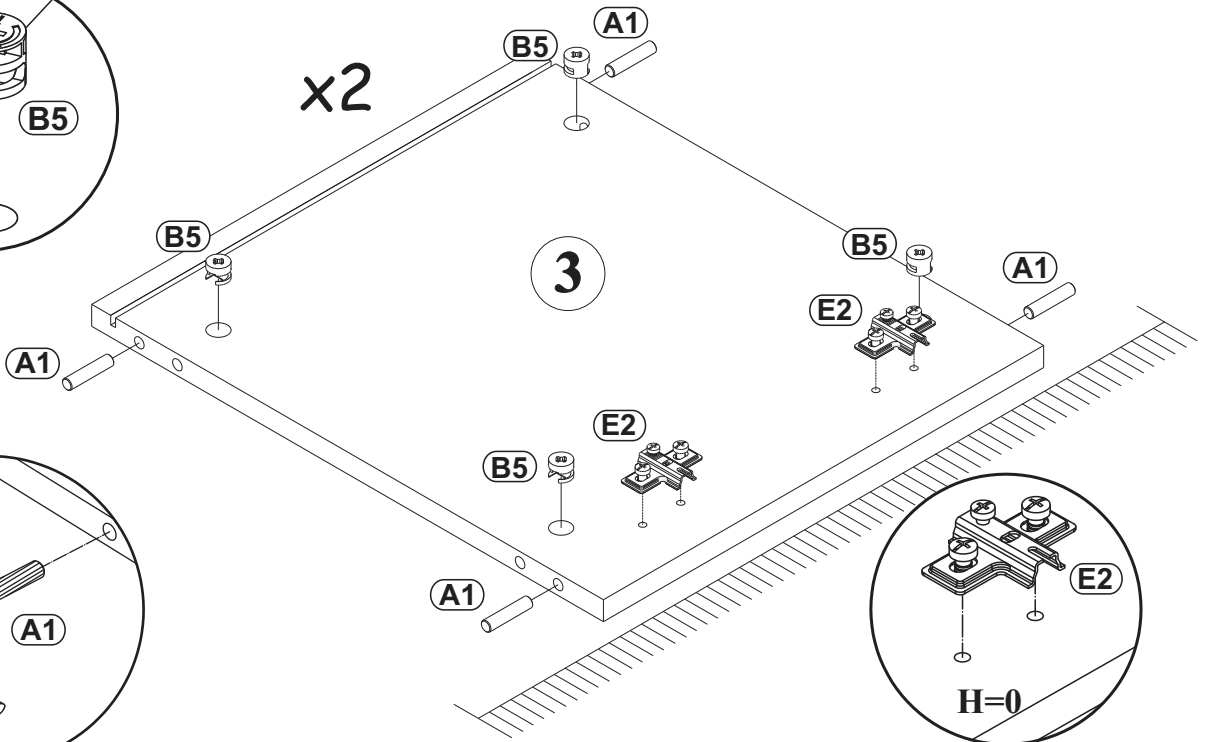
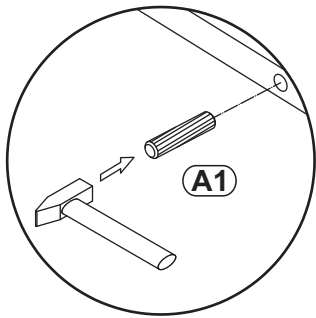
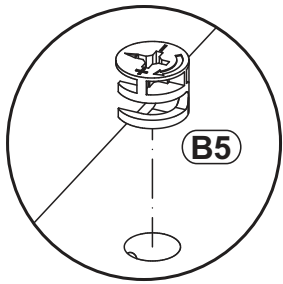

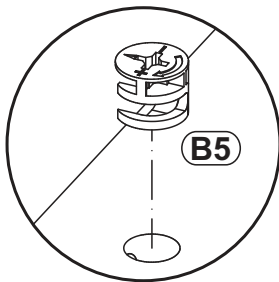
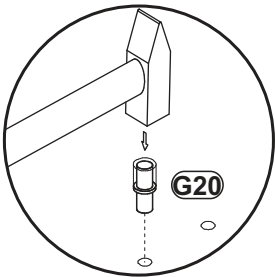

2

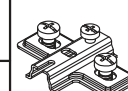

E4	
x2	H=2

A1	
x4	ø8x36

B5	
x4	Ø15x12

G20	
x2	

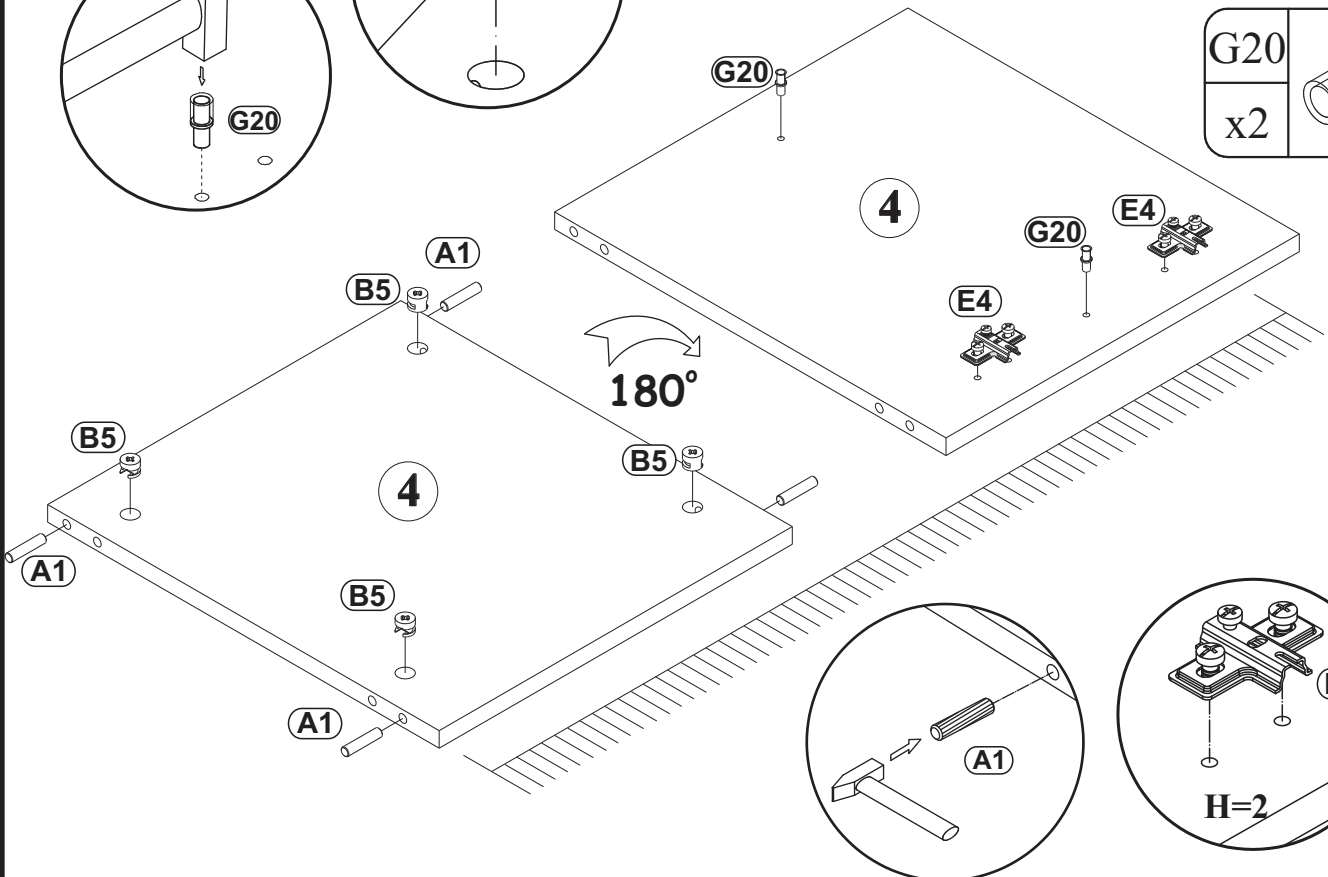

3

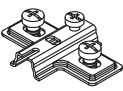
E4	
x2	H=2

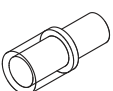
G20	
x2	

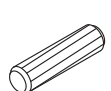
A1	
x4	ø8x36

B5	
x4	Ø15x12

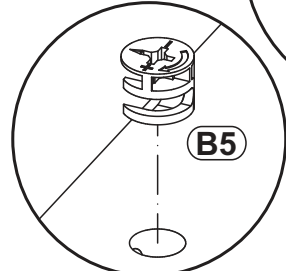
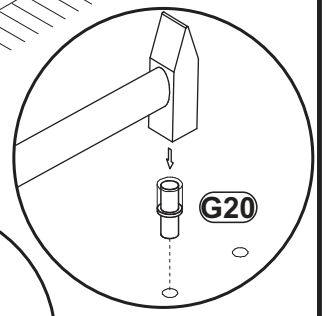
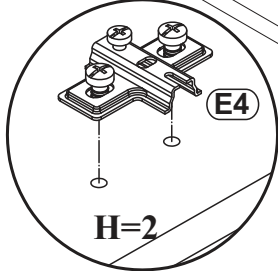
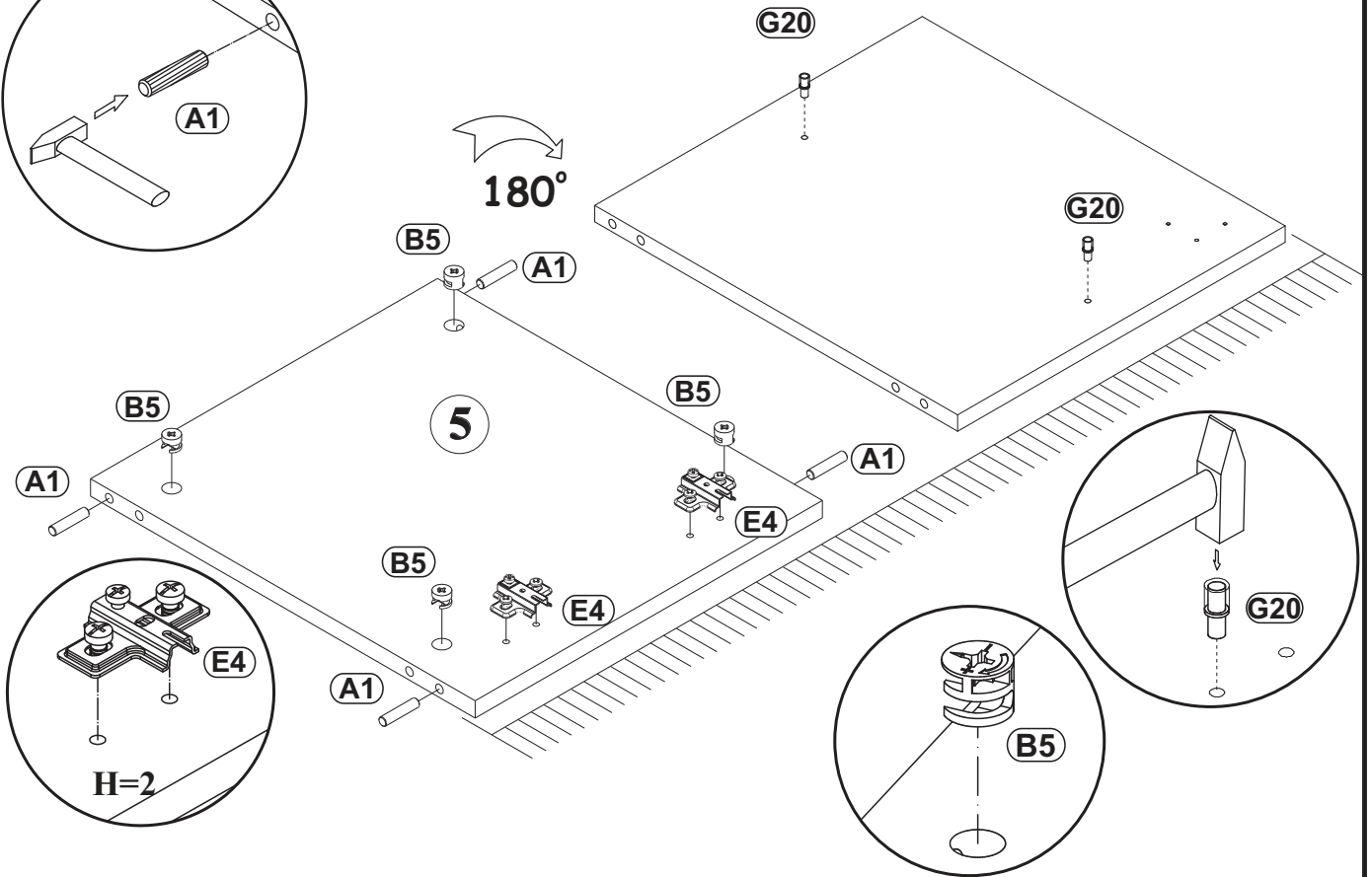
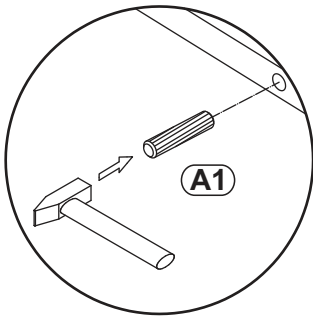

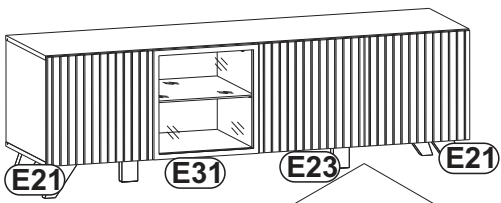

4

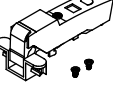

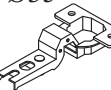
E31	
x2	H=8

E23	
x2	Ø35 H=8

E21	
x4	Ø35 H=0

D10	
x12	USØ3,5x13

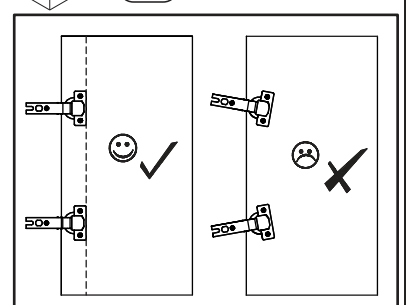
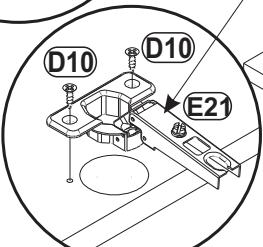
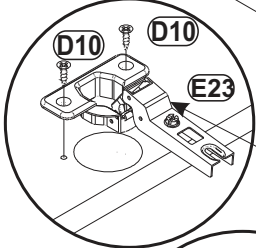
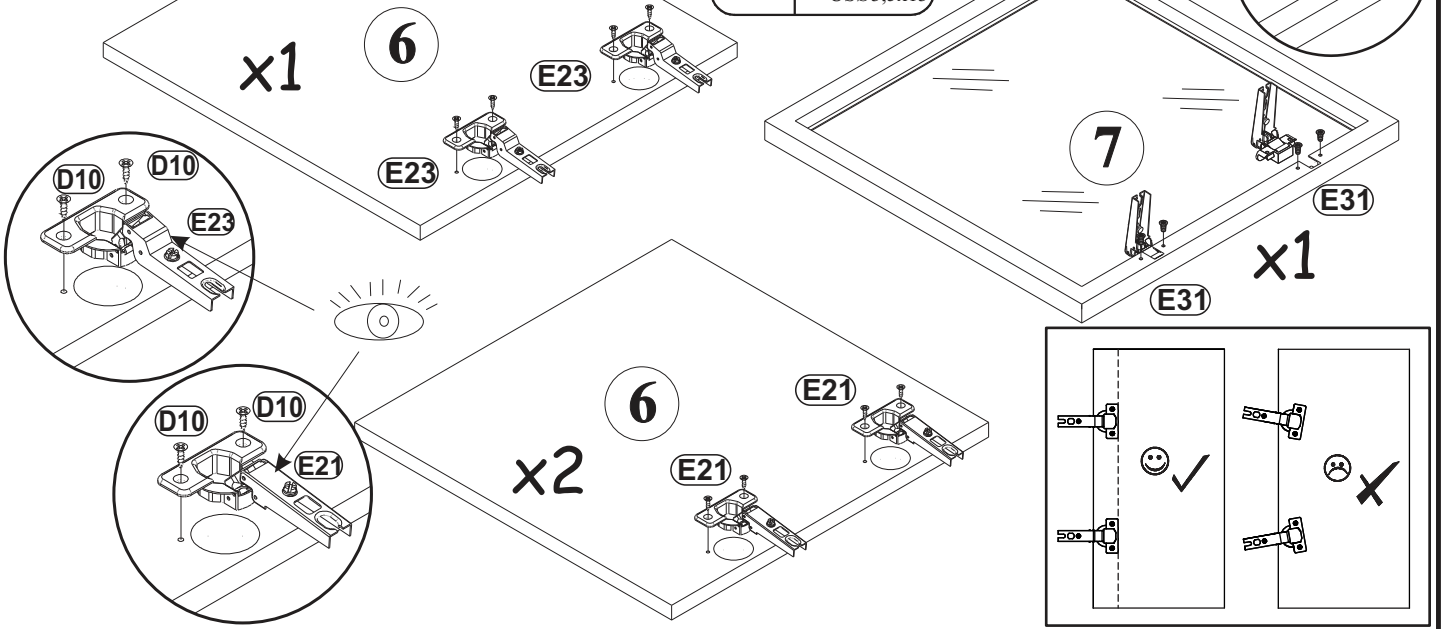
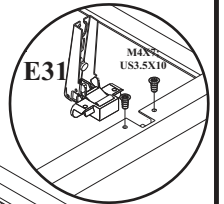

B4

x8

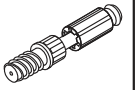

5

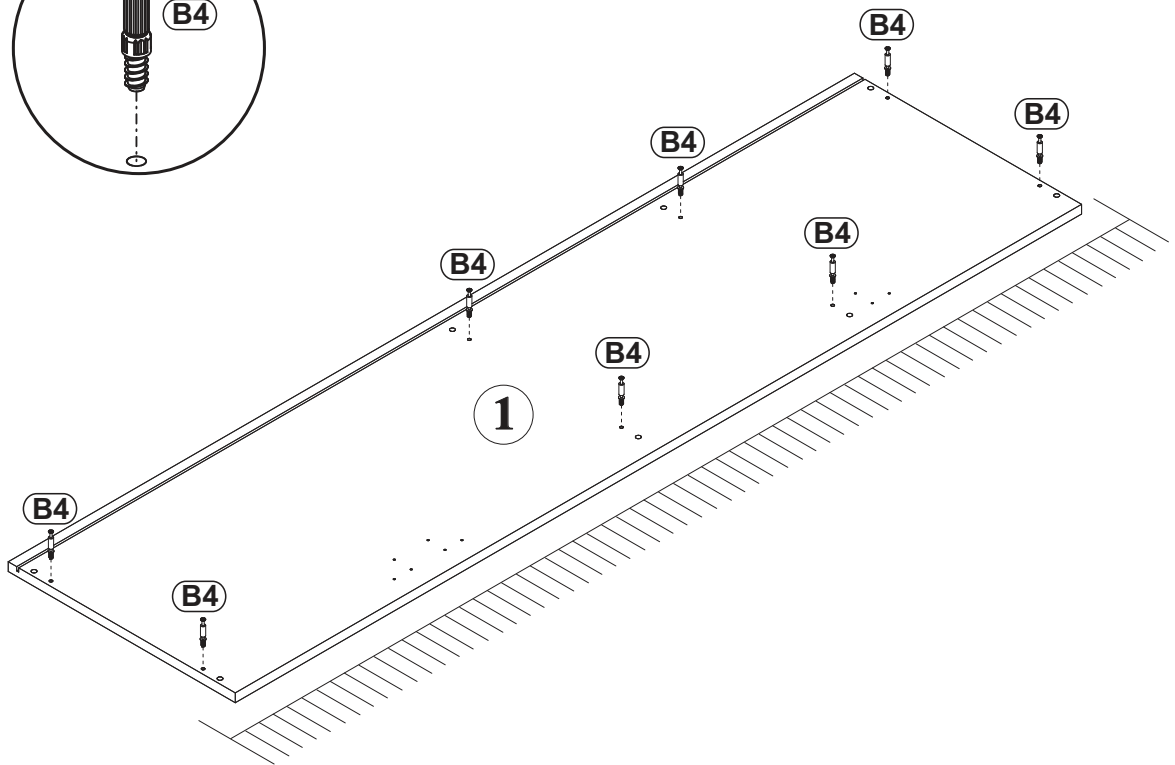
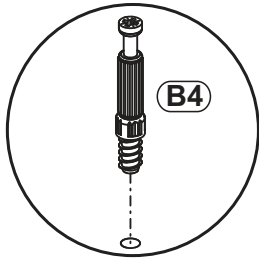

6

G4	
x12	

B11	
x12	Ø7x50

SK	
x4	H=120

SP	
x2	H=120

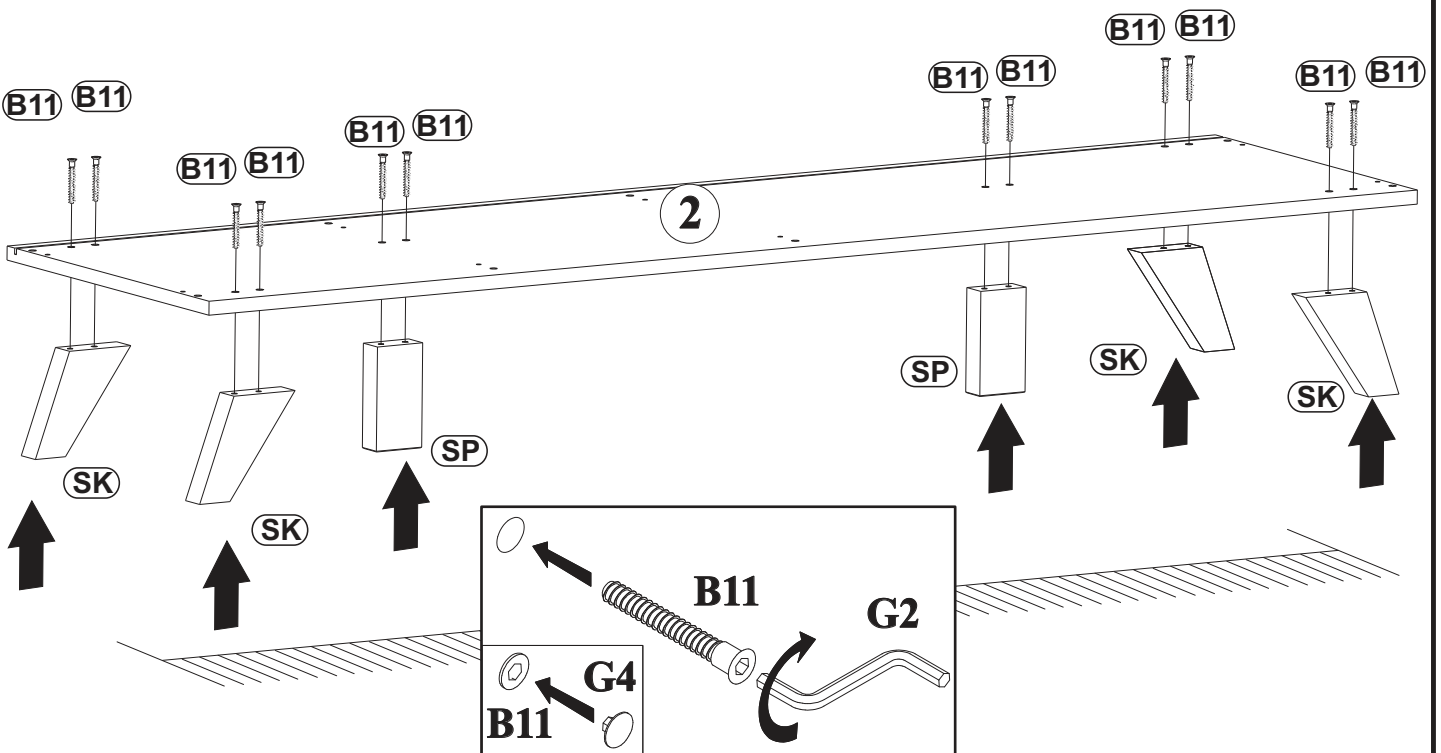

7

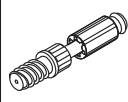
B4	
x8	

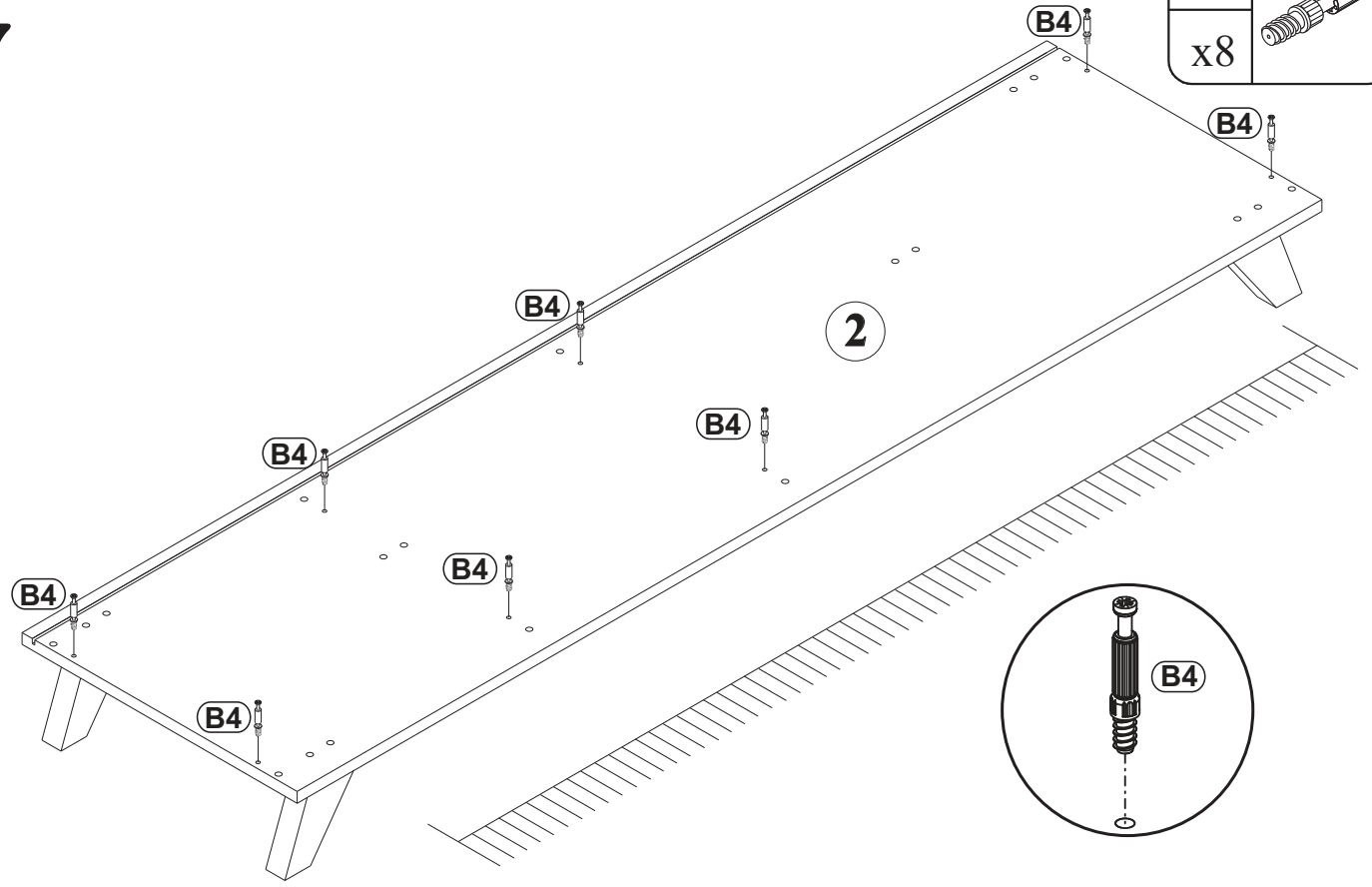

8

G5	
x8	

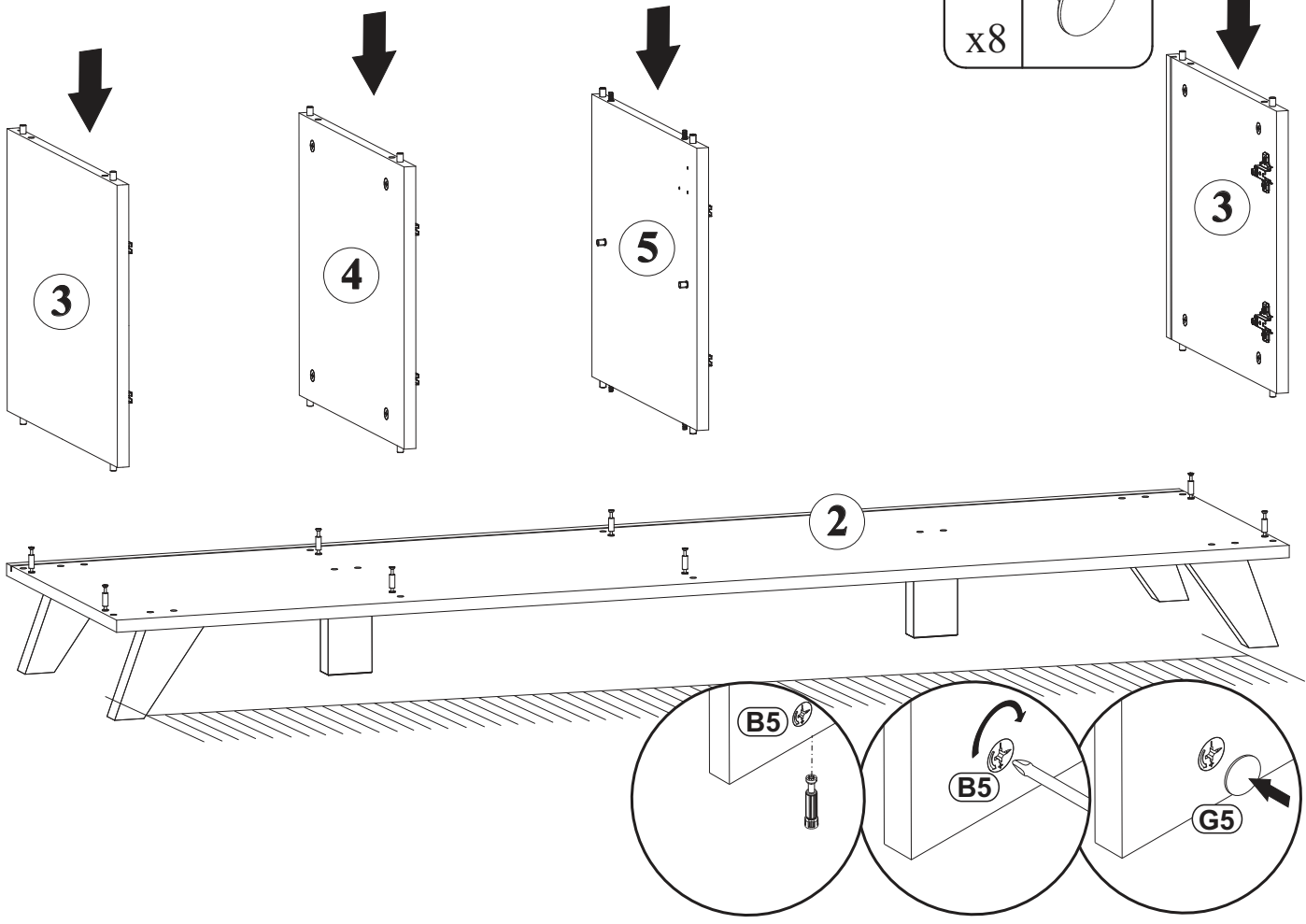



9

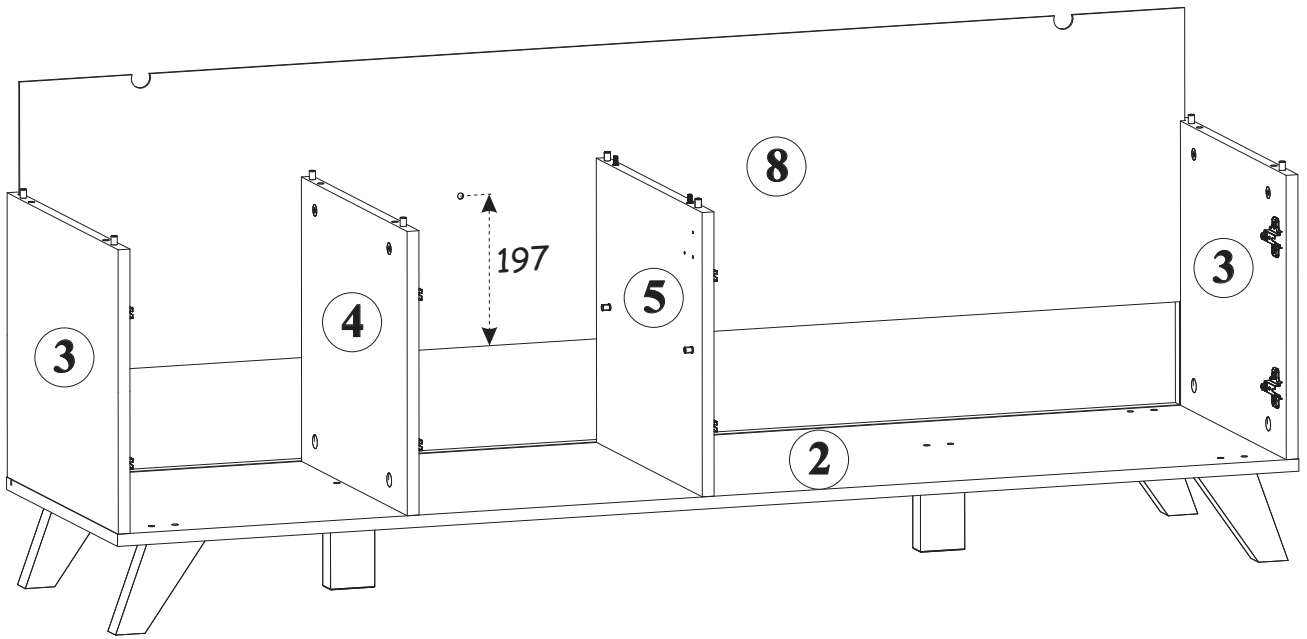

10



G5	
x8	

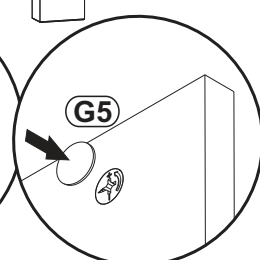
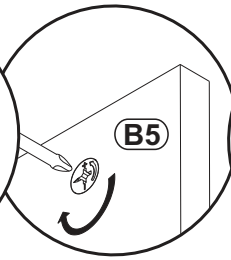
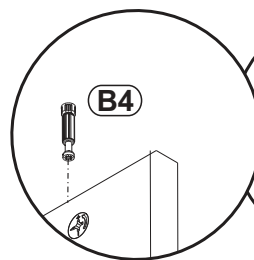
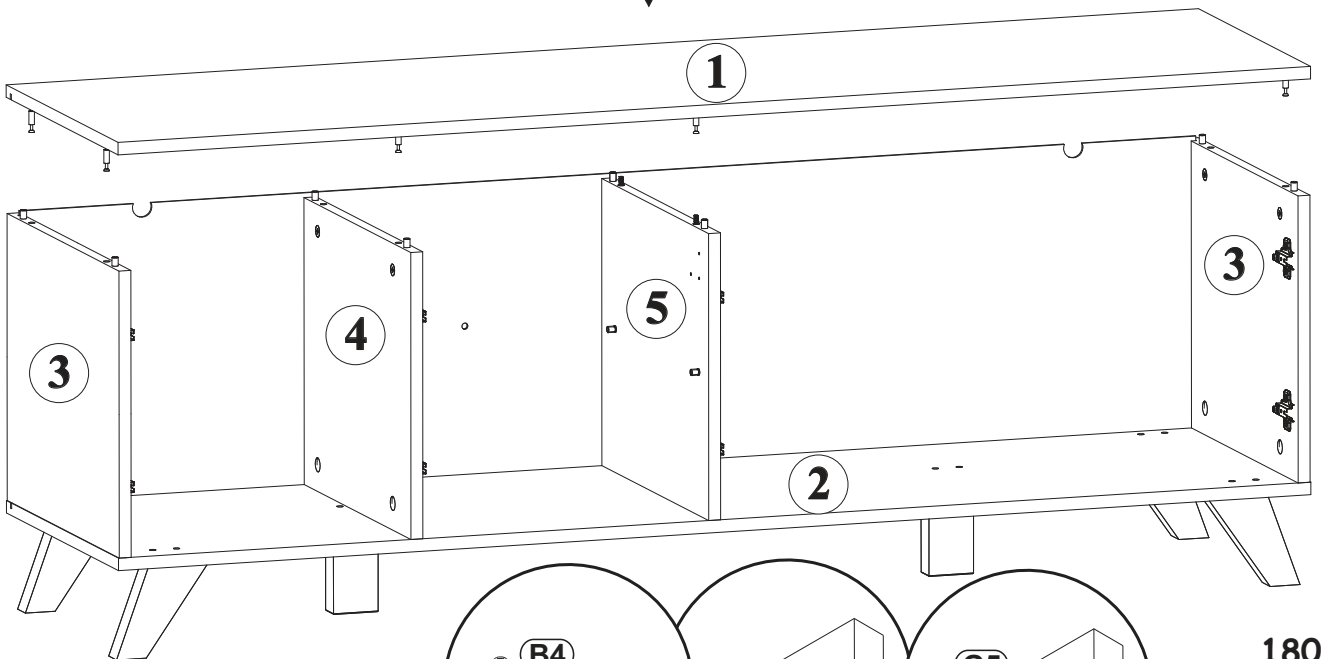

11

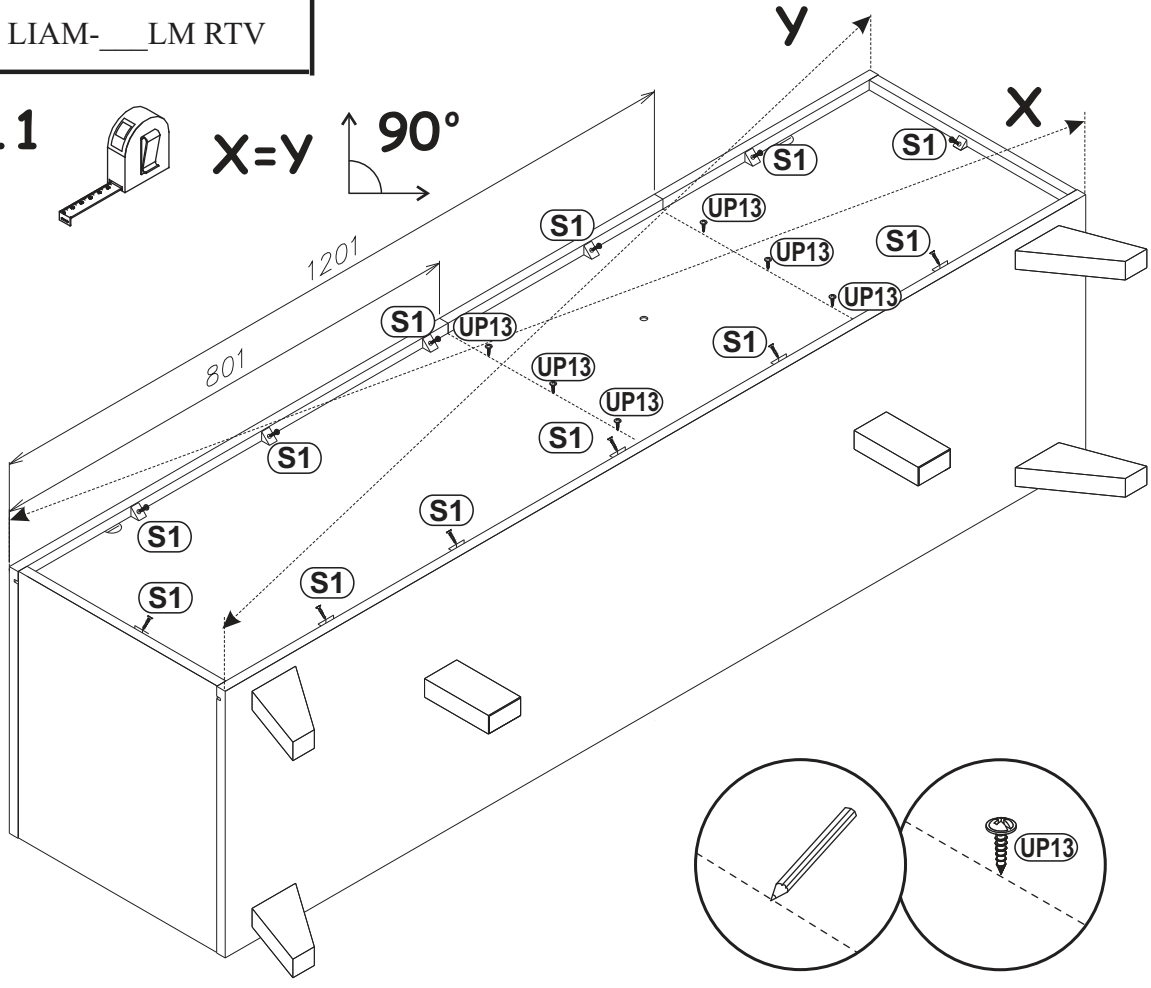

S1	
x12	

UP13	
x6	UP03x16

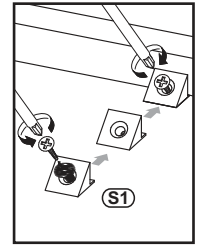
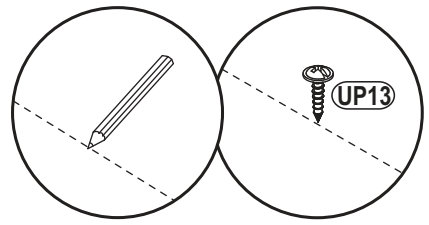

12

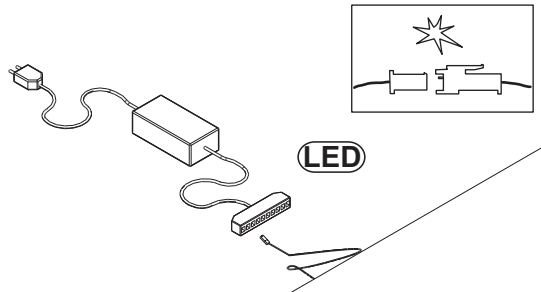

LED	
x1	1x1

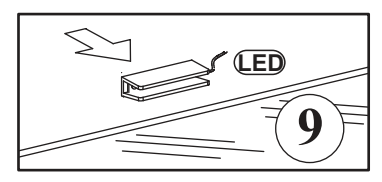
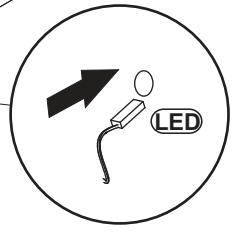
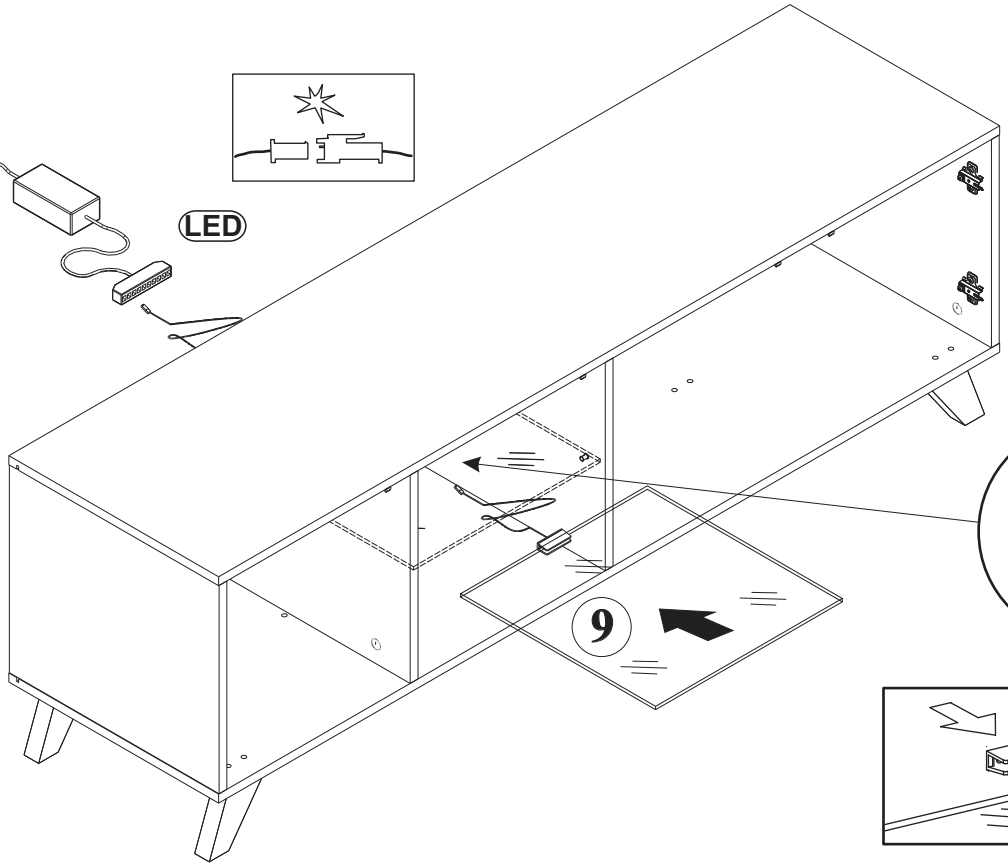

13

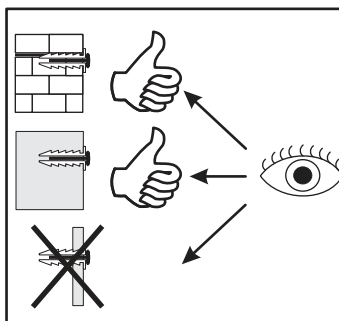
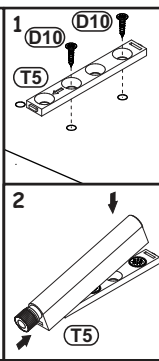
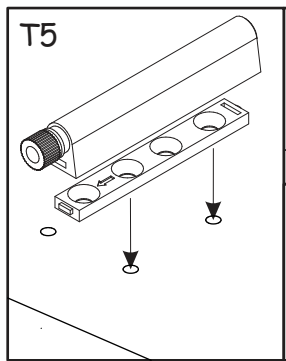
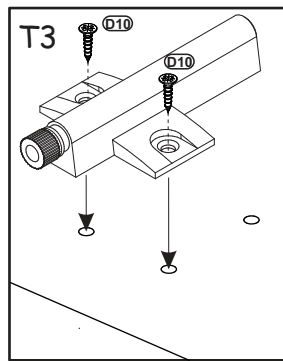
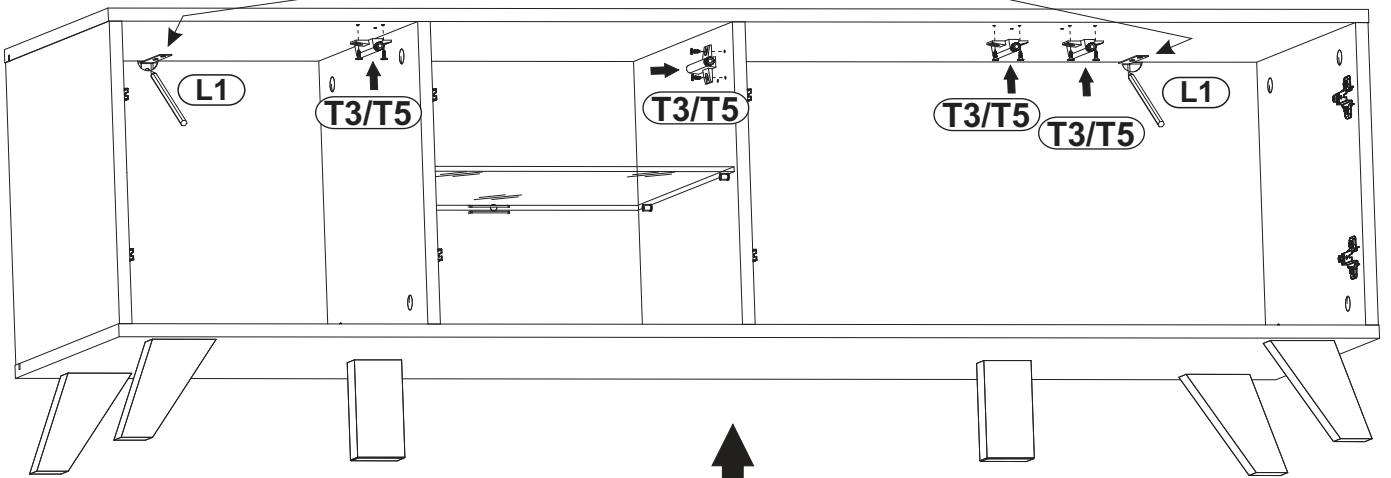
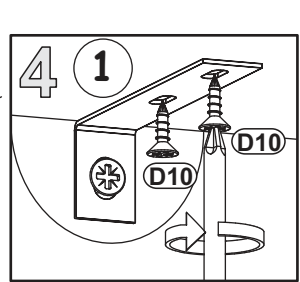
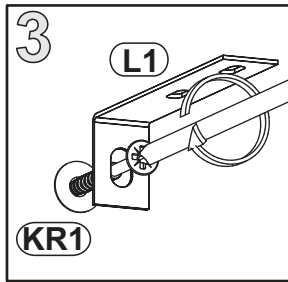
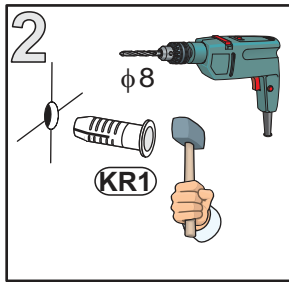
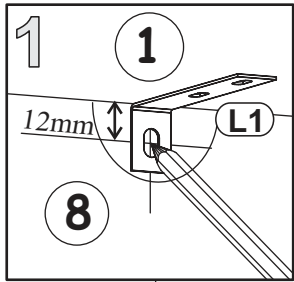
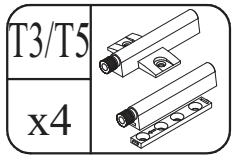
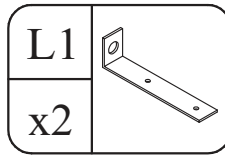
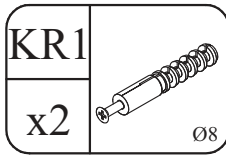
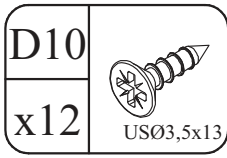

14

