

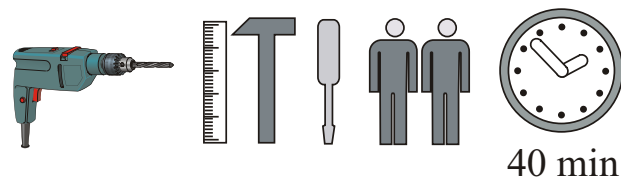

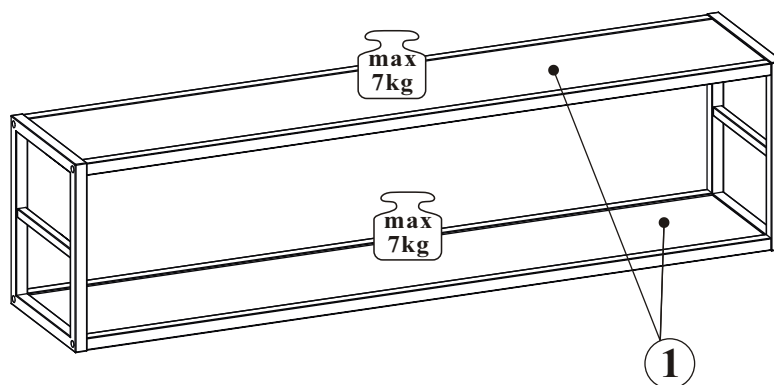

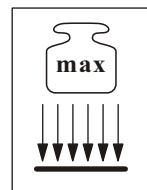

SWITCH 27_SW RM7

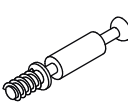

| NO | Dim. | | | Col.-No | Qty |
|----|------|-----|----|---------|-----|
| 1 | 1160 | 208 | 16 | 1 | 2 |

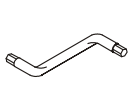
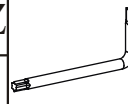
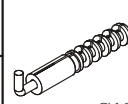
SWITCH 27__SW RM7

| | | | | | | | | | | | |
|-----------|---|------------|--|-----------|---|----------|--|-----------|---|-----------|--|
| B5 x20 |  Ø15x12 | B20 x20 |  | G5 x20 |  | G2 x1 |  | GSZ x1 |  | KR3 x4 |  Ø10 |
| D60 x8 |  M6x30 | G12 x8 |  Ø14 | | | | | | | | |

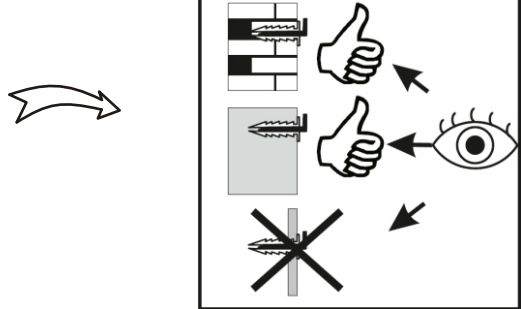
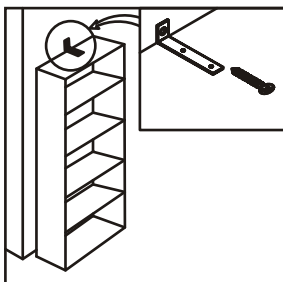
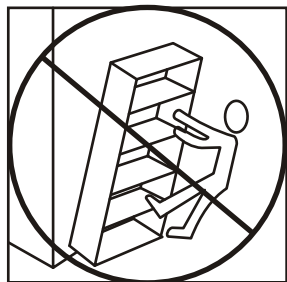
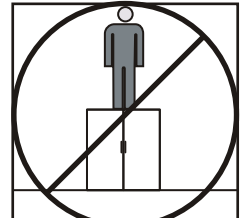
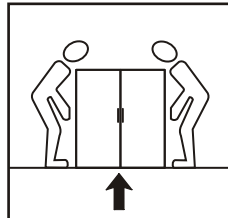
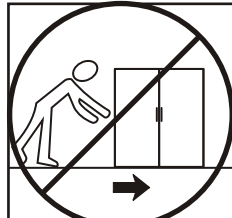
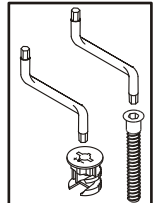
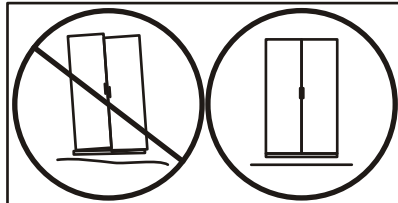
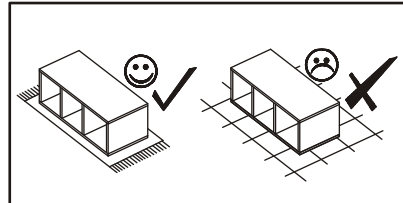
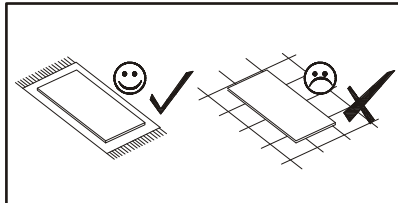
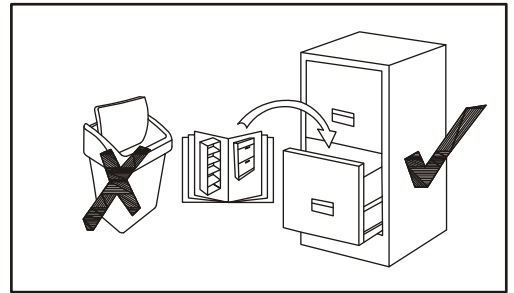
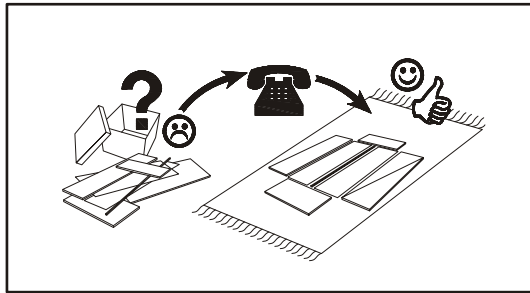
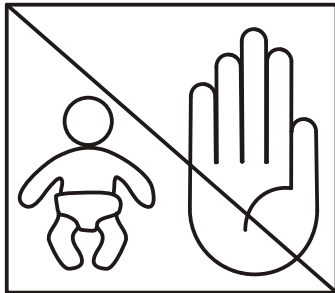
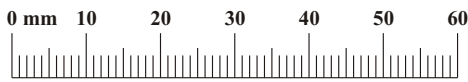
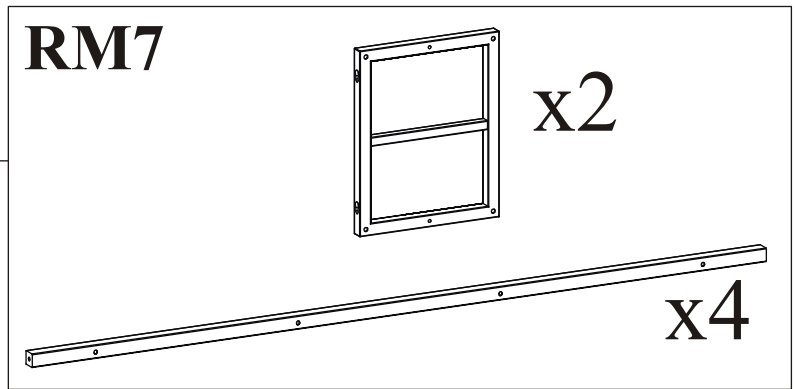
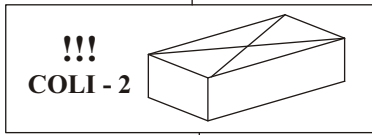

SWITCH 27__SW RM7

B5

x20



1

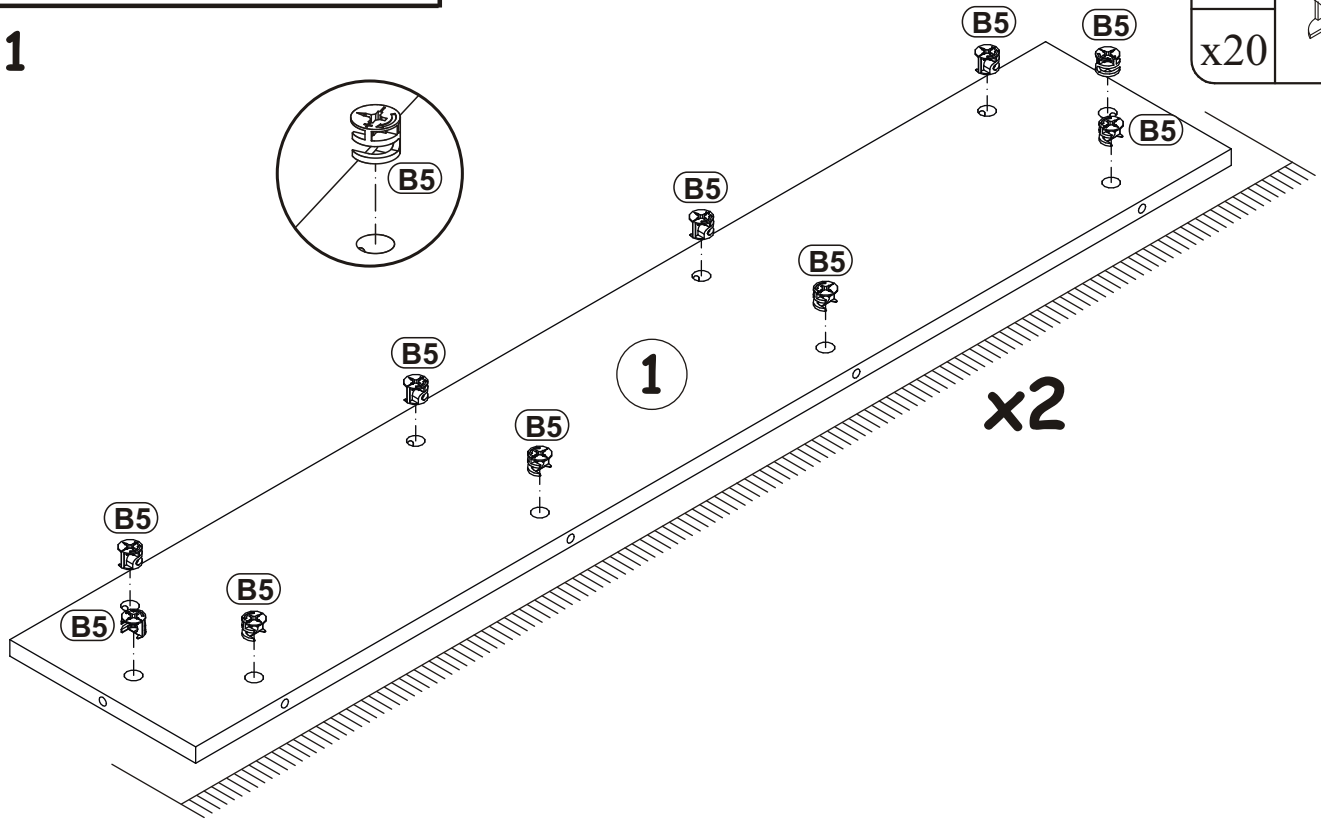

2

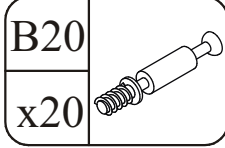

RM7

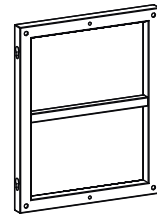

x2

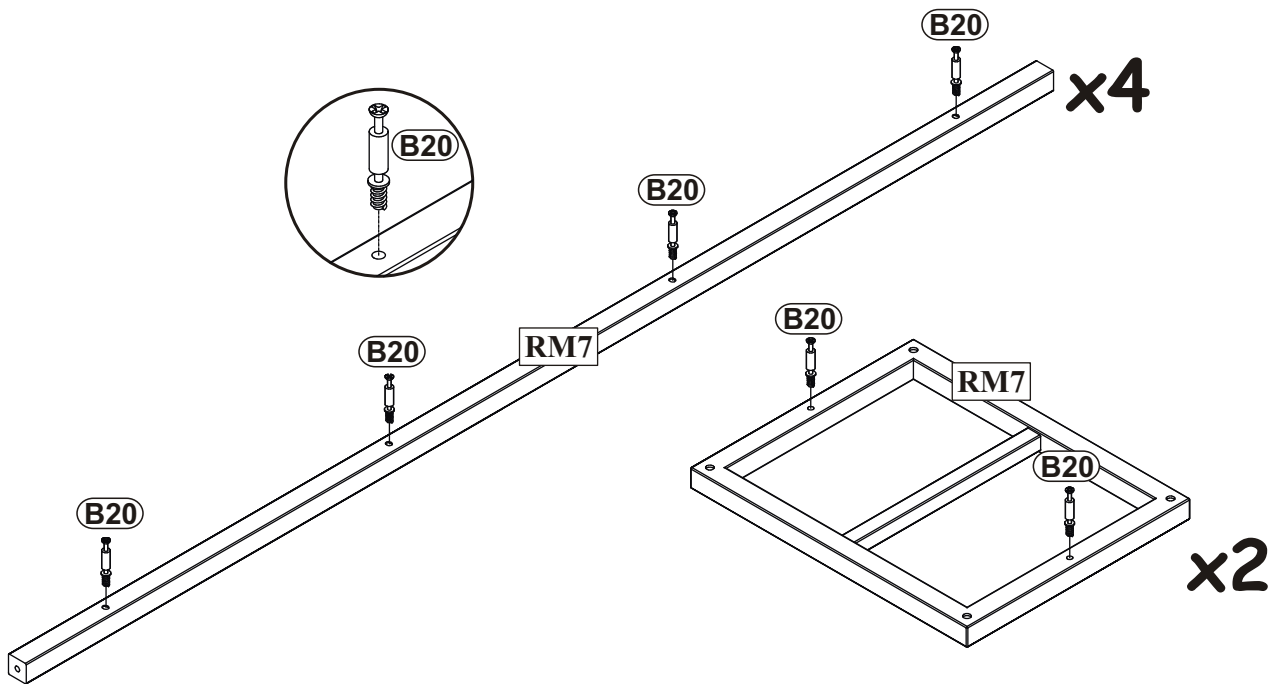
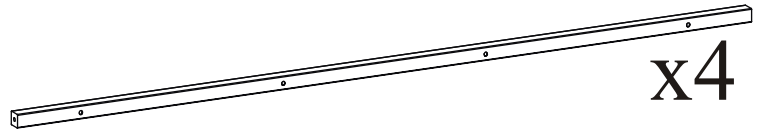
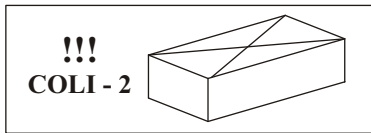

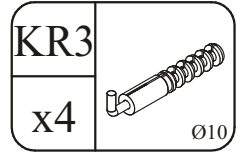

5

