

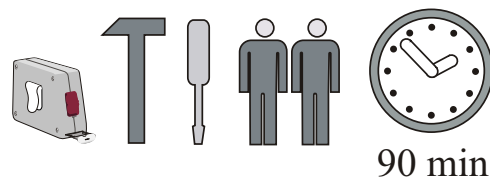

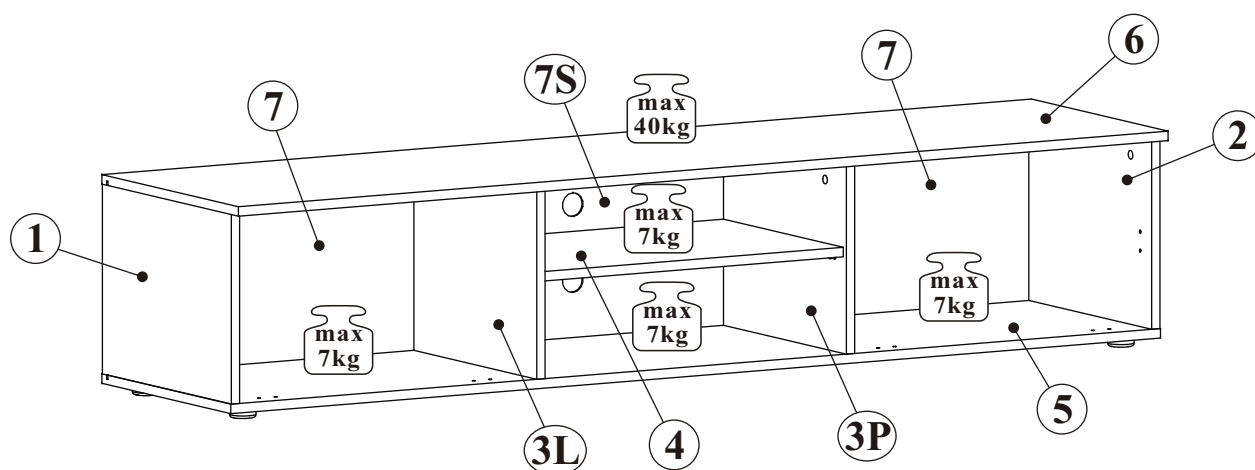

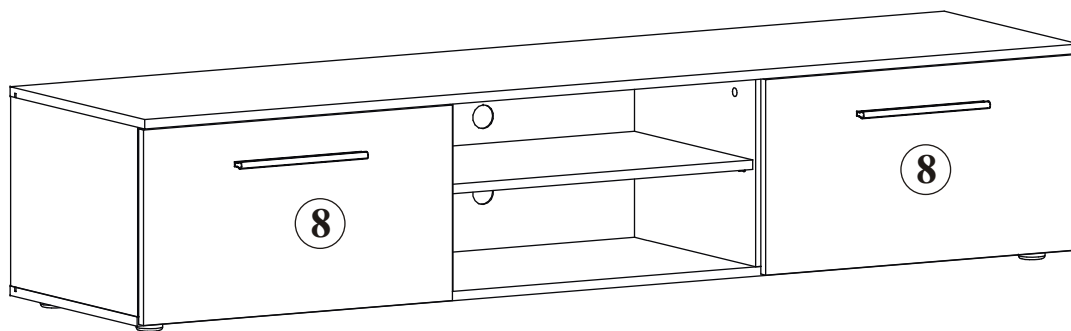

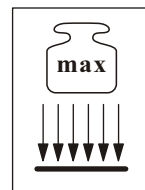

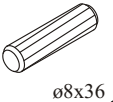
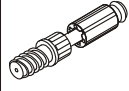

GALINO 26_B2

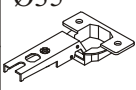
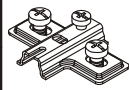
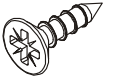

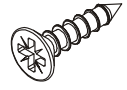
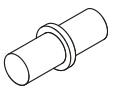
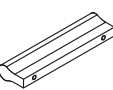
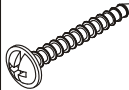
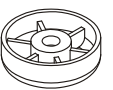
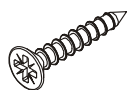
NO	Dim.			Col.-No	Qty
1	320	425	16	1	1
2	320	425	16	1	1
3L	320	405	16	1	1
3P	320	405	16	1	1
4	584	395	16	1	1
5	1802	425	16	1	1
6	1802	450	16	1	1
7S	598	332	3	1	1
7	589	332	3	1	2
8	596	330	16	1	2

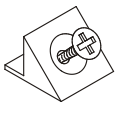
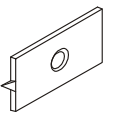
GALINO 26_B2

A1 x16  ø8x36	B4 x8 	B5 x8  Ø15x12	G5 x8 	B11 x8  Ø7x50	G4 x8 
E21 x4 Ø35  H=0	E2 x4  H=0	D10 x14  USØ3,5x13	G21 x2 	D7 x6  USØ3x16	G7 x4 
KL x2  L-224mm.	UP6 x4  UPØ4x30	I11 x6  Ø45, h=15	D11 x6  USØ3,5x25	G19 x2  Ø20	S1 x14 
G16 x4 	UP13 x4  UPØ3x16	G2 x1 			

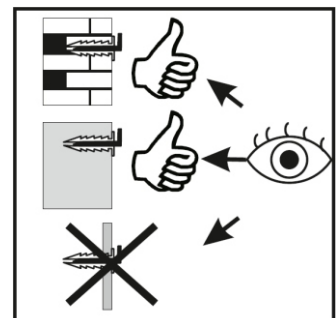
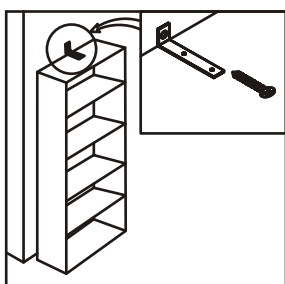
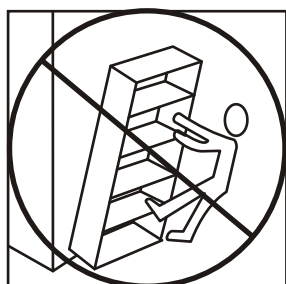
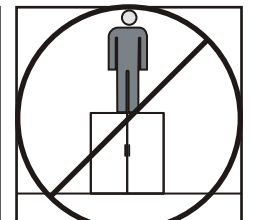
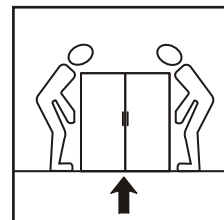
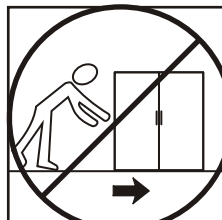
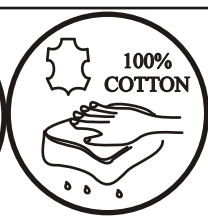
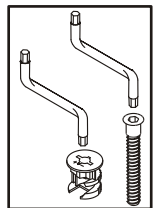
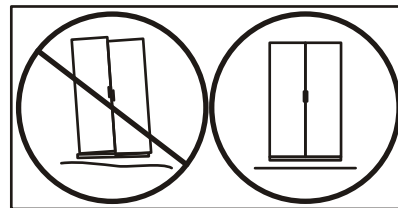
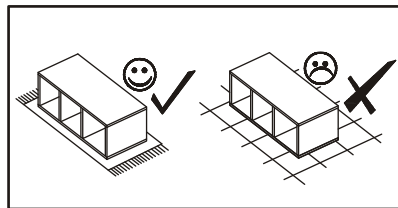
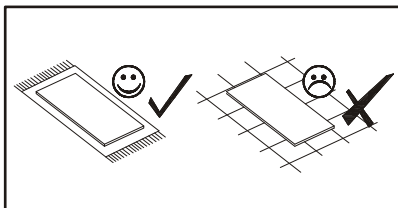
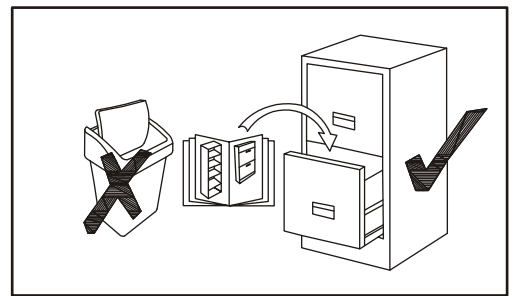
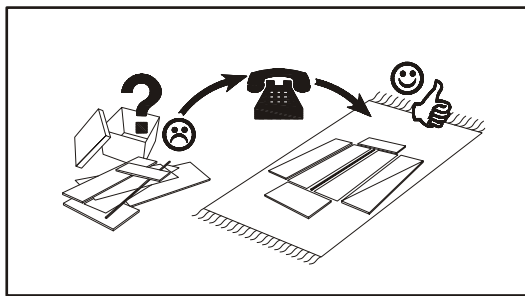
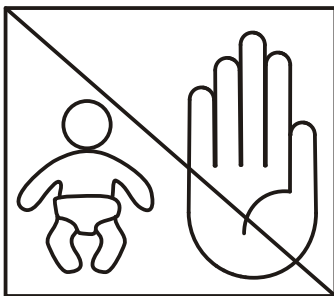
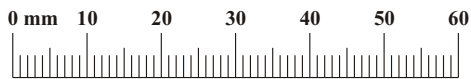

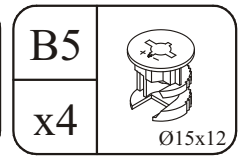
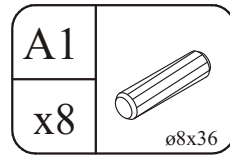

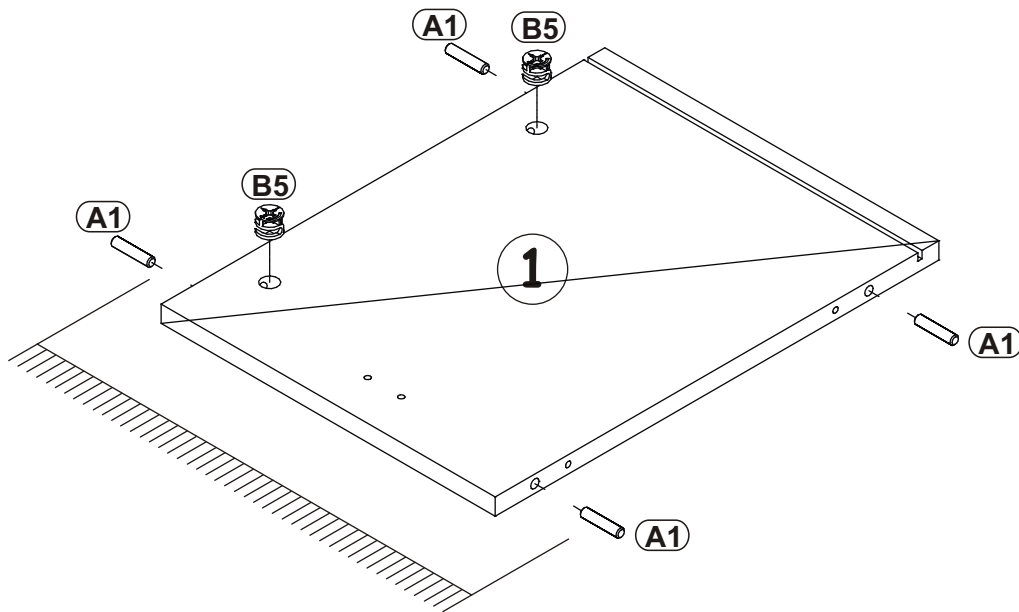
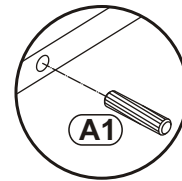
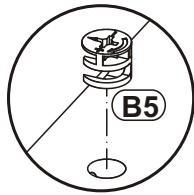
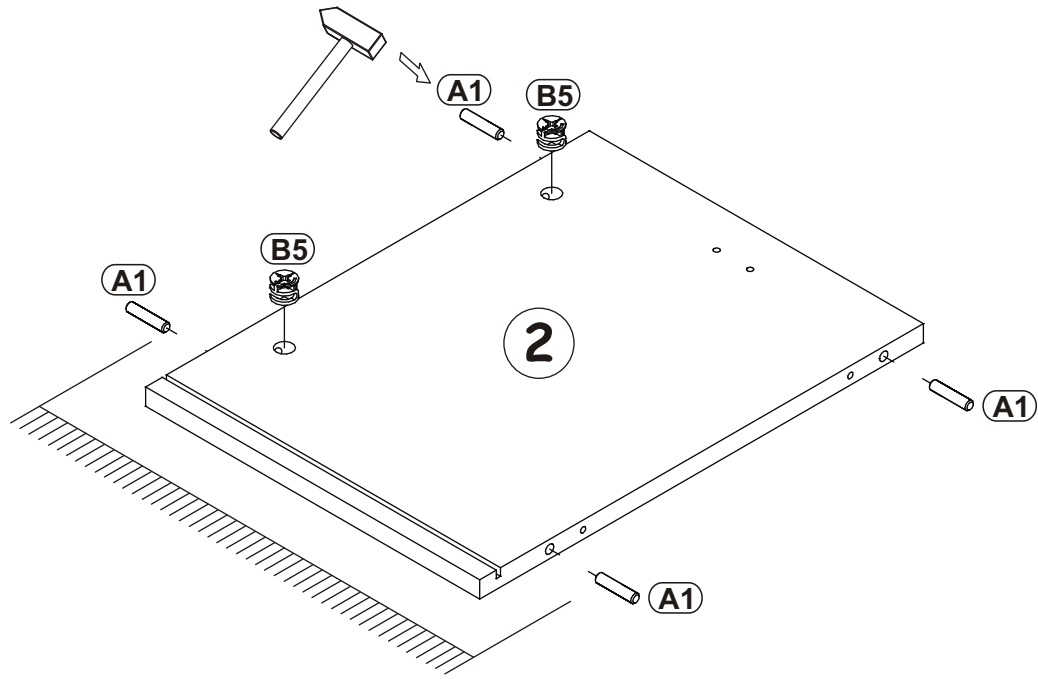

1



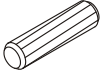

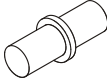
2

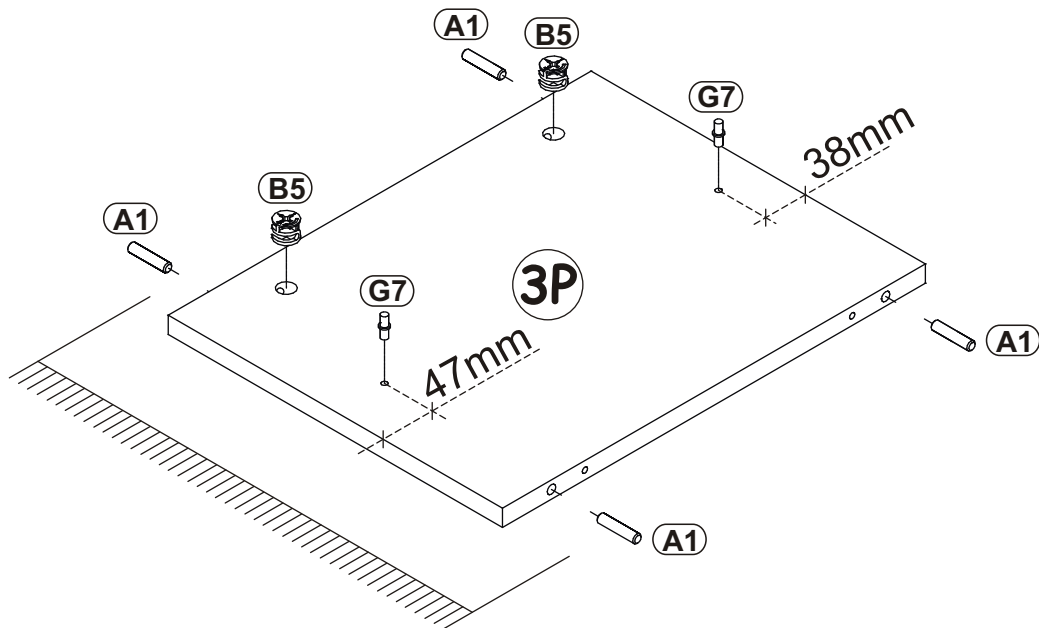
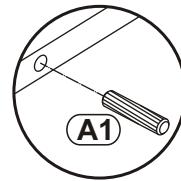
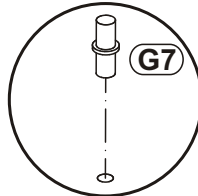
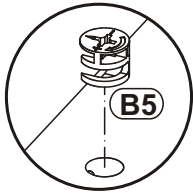
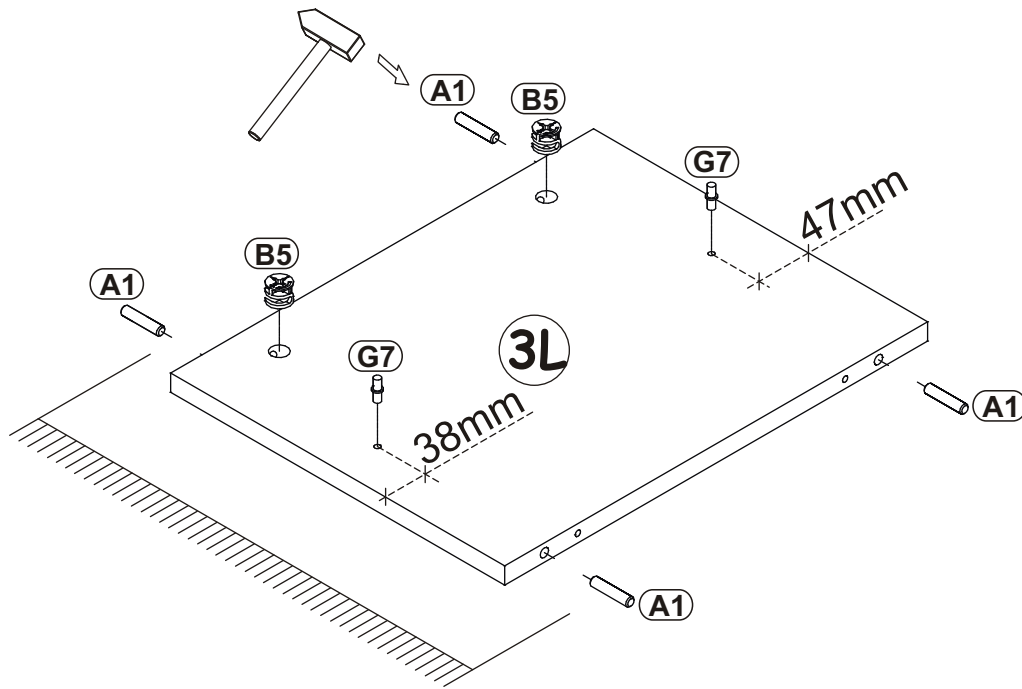
A1		B5		G7	
x8	ø8x36	x4	Ø15x12	x4	

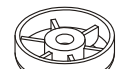

3

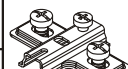
I11		D11		E2	
x6	Ø45, h=15	x6	USØ3,5x25	x4	H=0

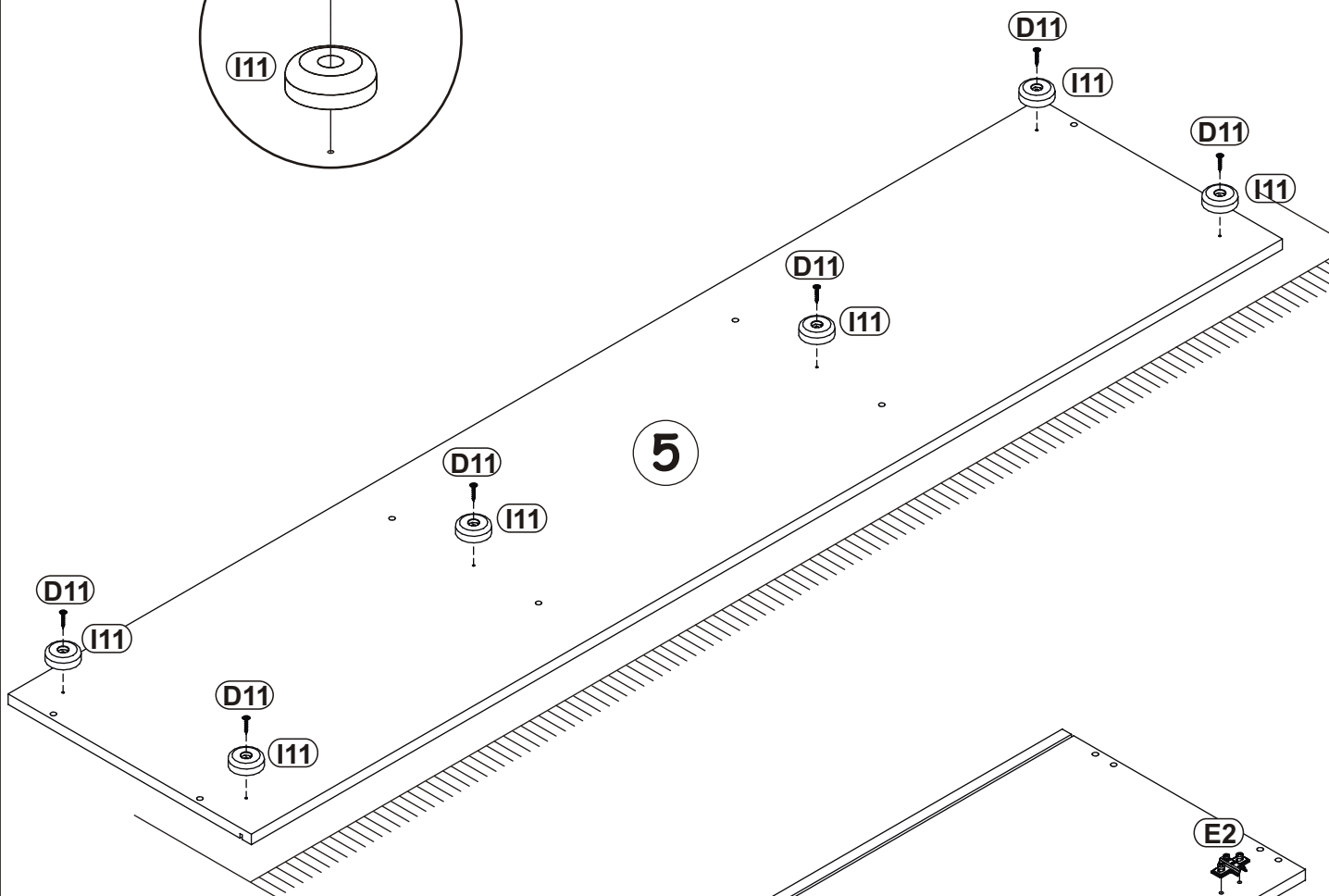
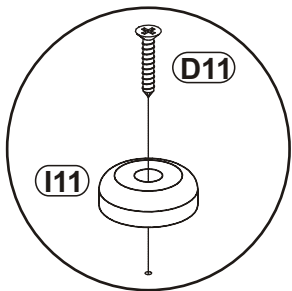

180°

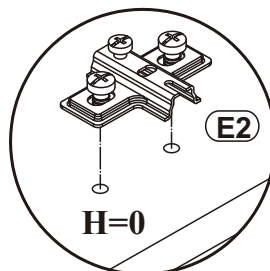
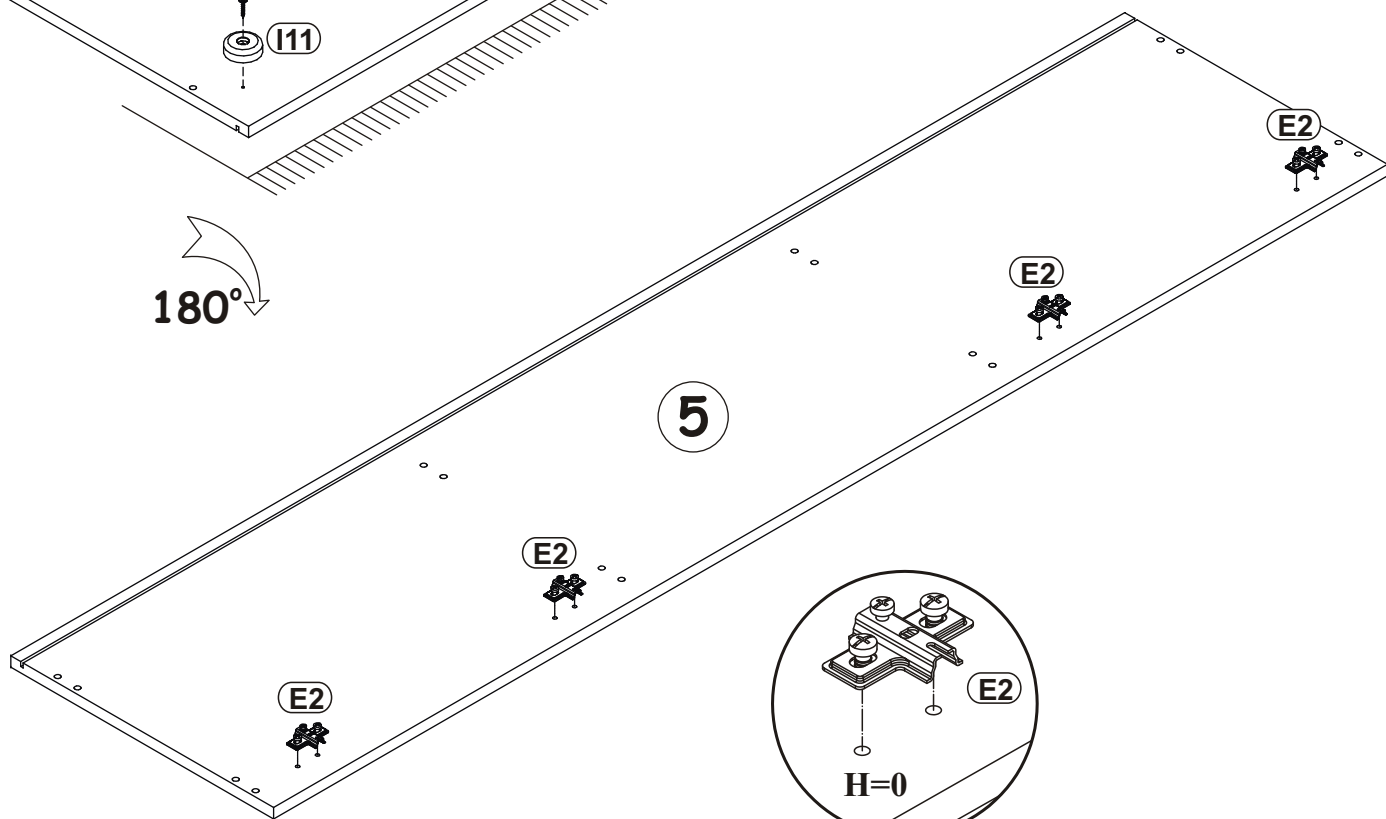

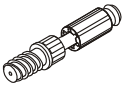

4

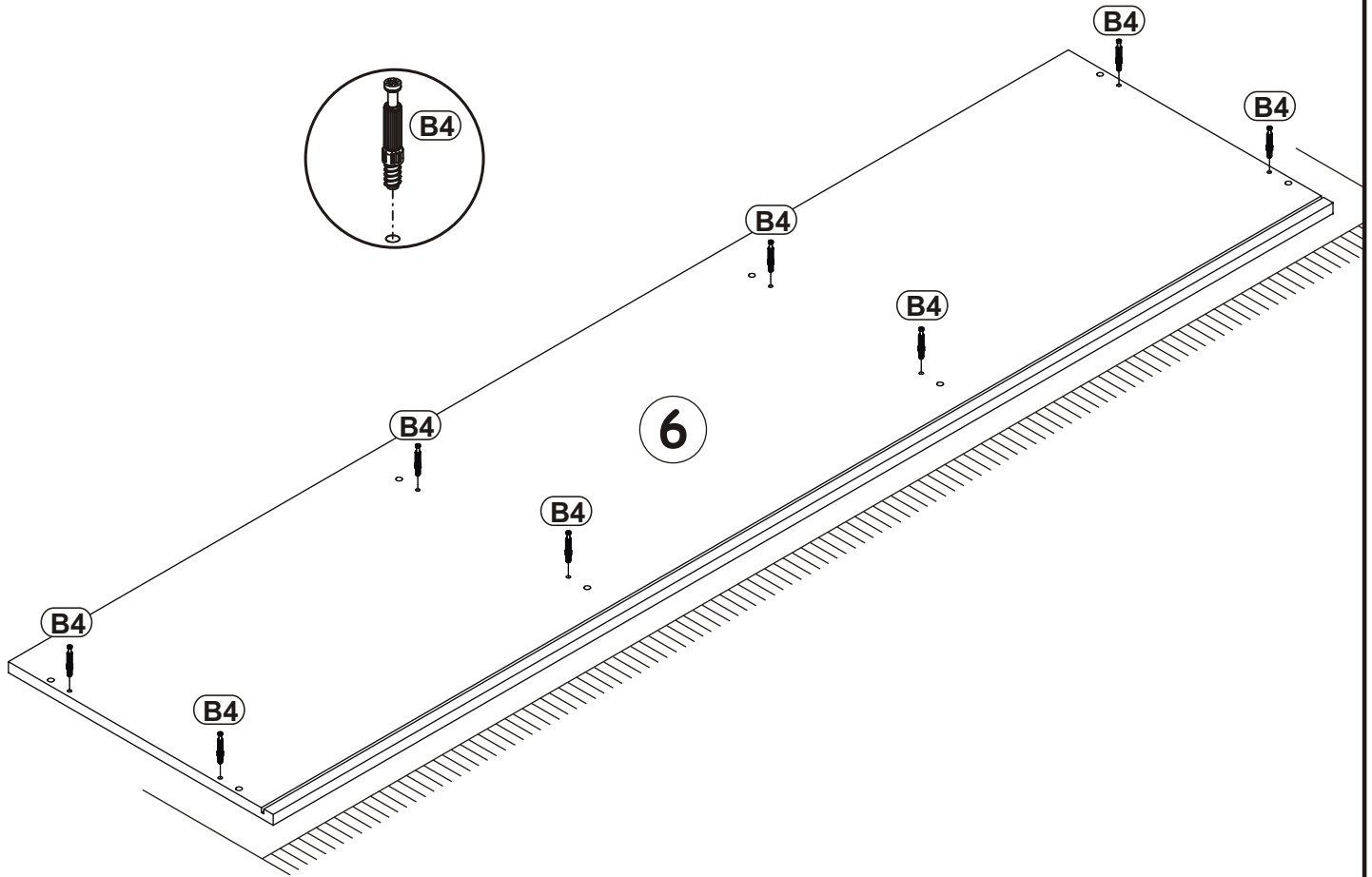
B4	
x8	



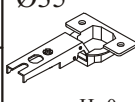

5

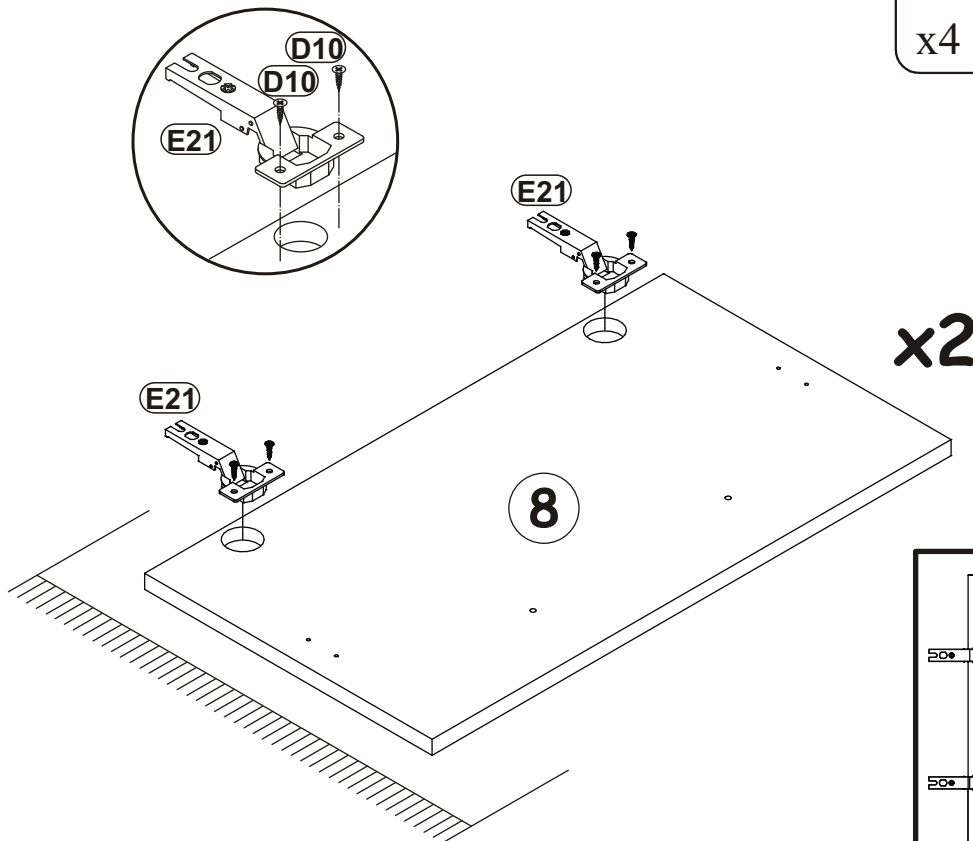
E21		D10	
x4	Ø35 H=0	x8	USØ3,5x13



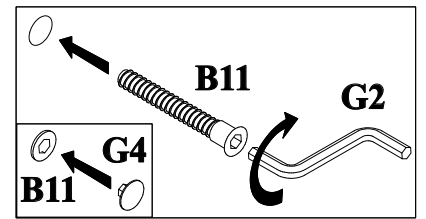
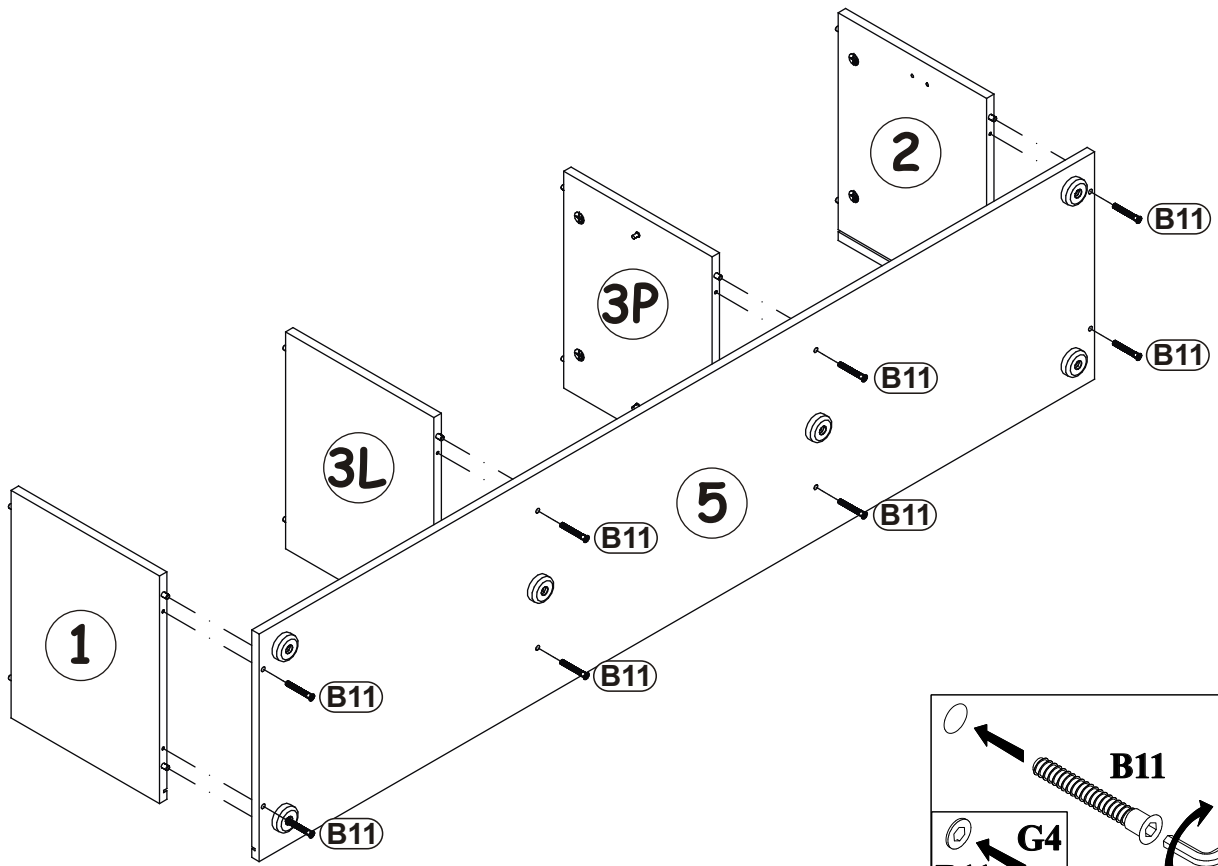

6

B11		G4	
x8	Ø7x50	x8	

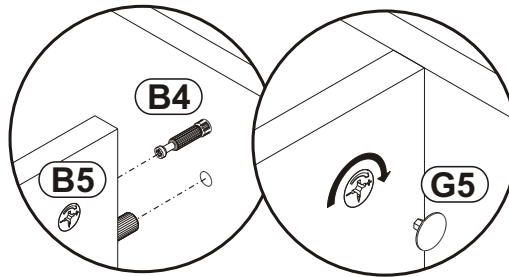

7



G5	
x8	

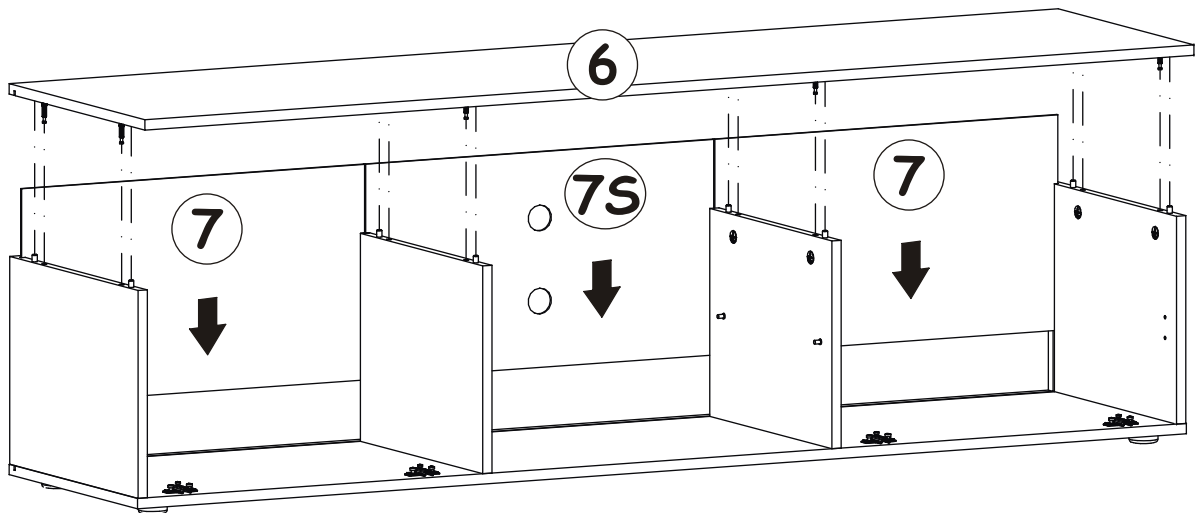

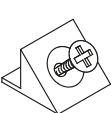
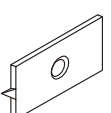
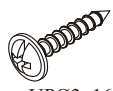
S1		G16		UP13	
x14		x4		x4	UPØ3x16

8

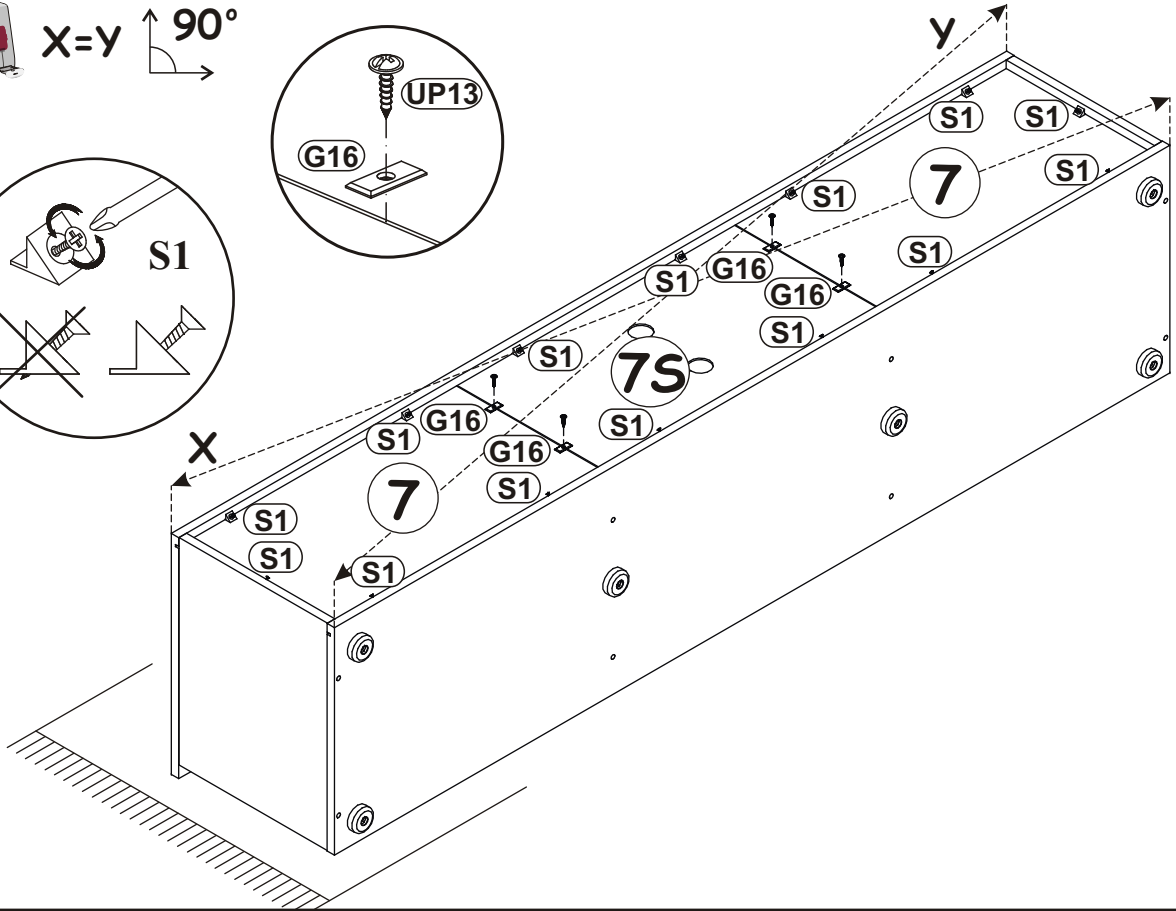
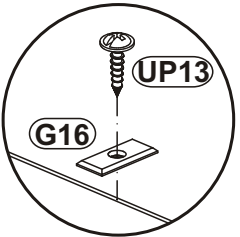
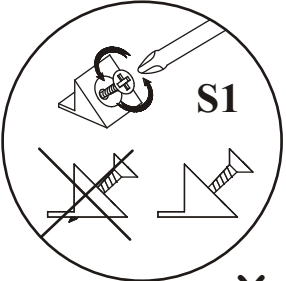

9

G19	
x2	Ø20

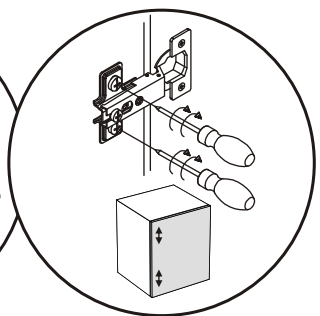
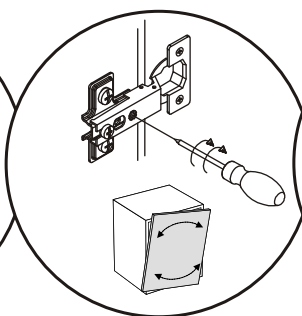
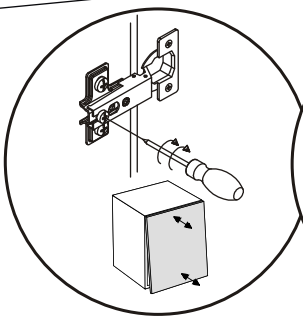
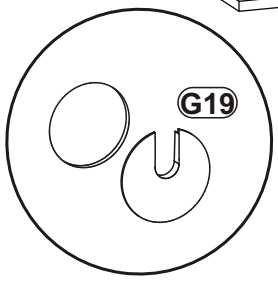
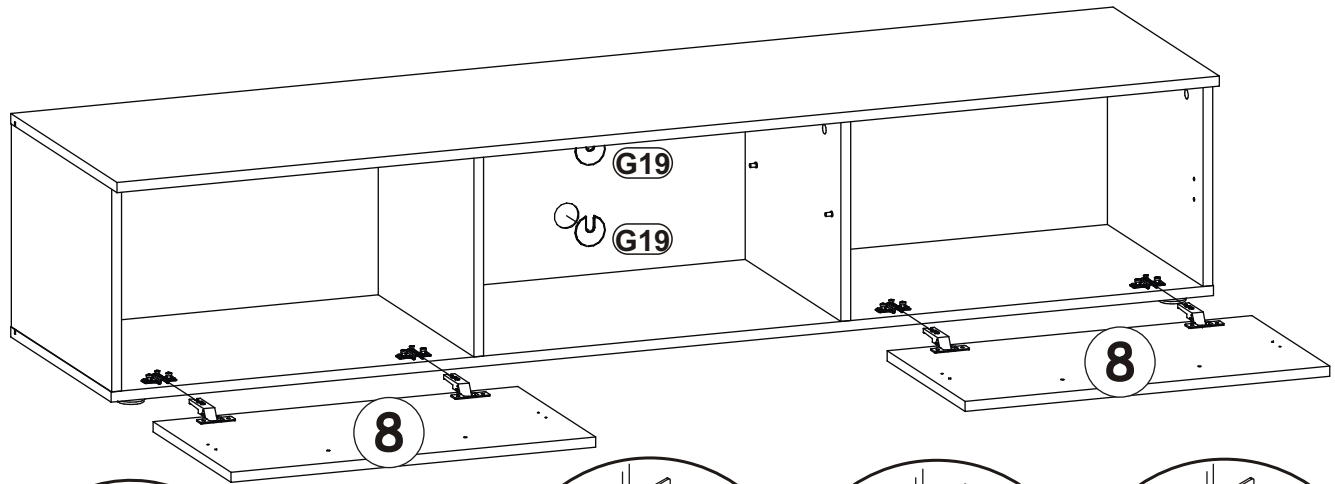

10

