

MONTAŽNI LIST (SERVICE-CARD)

Ime izdelka (Item name):
MIMI

KERLES, www.kerles.si
info@kerles.si Gsm: 041 638 348

Tip izdelka (type):
POSTELJA





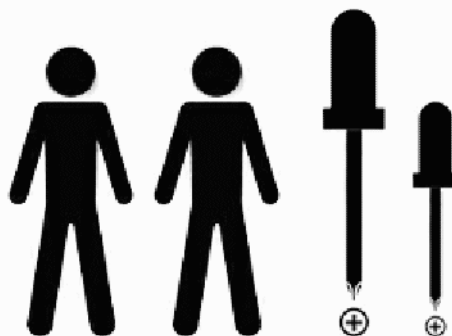
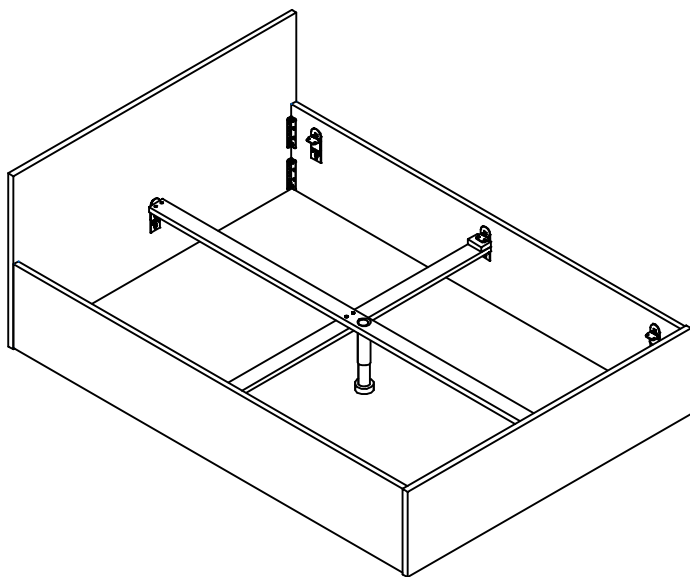

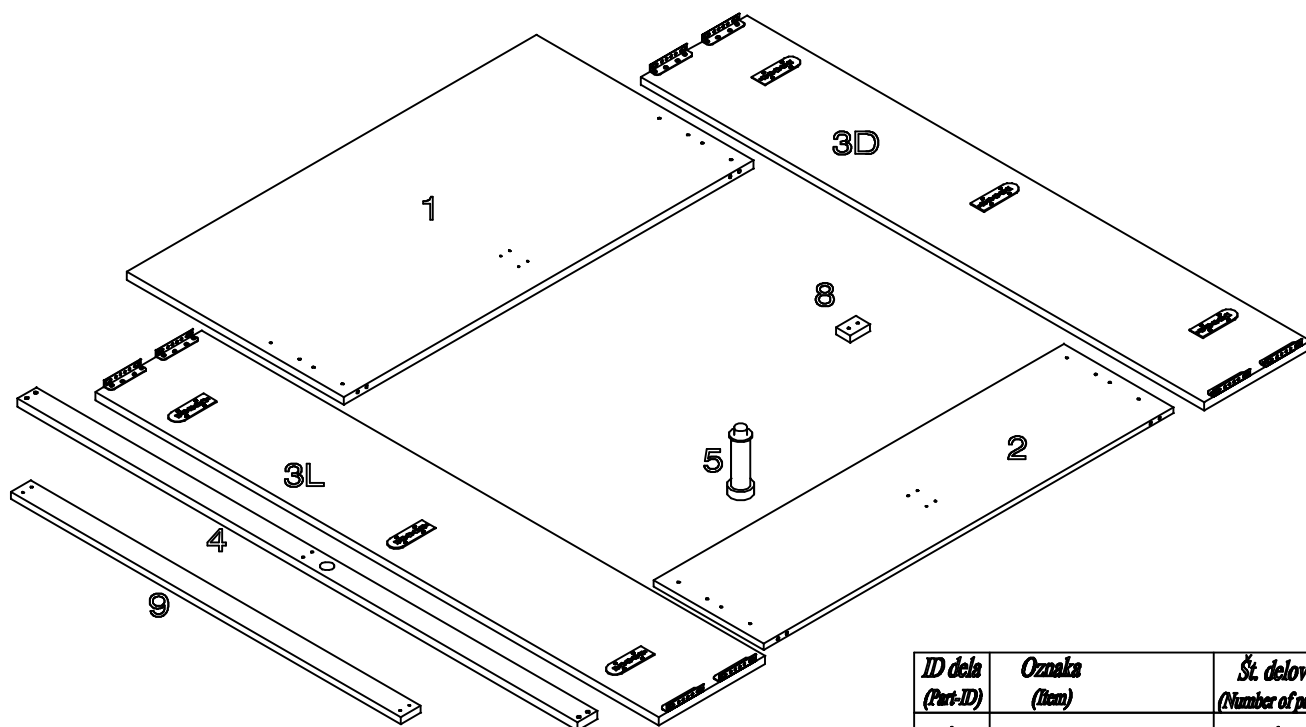

Dragi kupec,

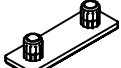
kupili ste proizvod podjetja Kerles. Za sestavo izdelka sta potrebni dve odrasli osebi. Pred pričetkom sestave izdelka si pozorno pogledajte montažne liste ter si elemente razvrstite tako, kot je prikazano na skici A.



Skica A



DR	 4X	VA	 6X	MA	 16X	DB	 2X
DC	 8X	MB	 4X	MC	 4X	MD	 4X
VB	 8X						

ID dela (Part-ID)	Oznaka (Item)	Št. delov (Number of parts)
1	Vzglavna končnica	1
2	Vznožna končnica	1
3D	Stranica desna	1
3L	Stranica leva	1
4	Srednja letev	1
5	Srednja noga PVC	1
8	Distančnik	2
9	Križna vez	1

Korak (Step) 1:

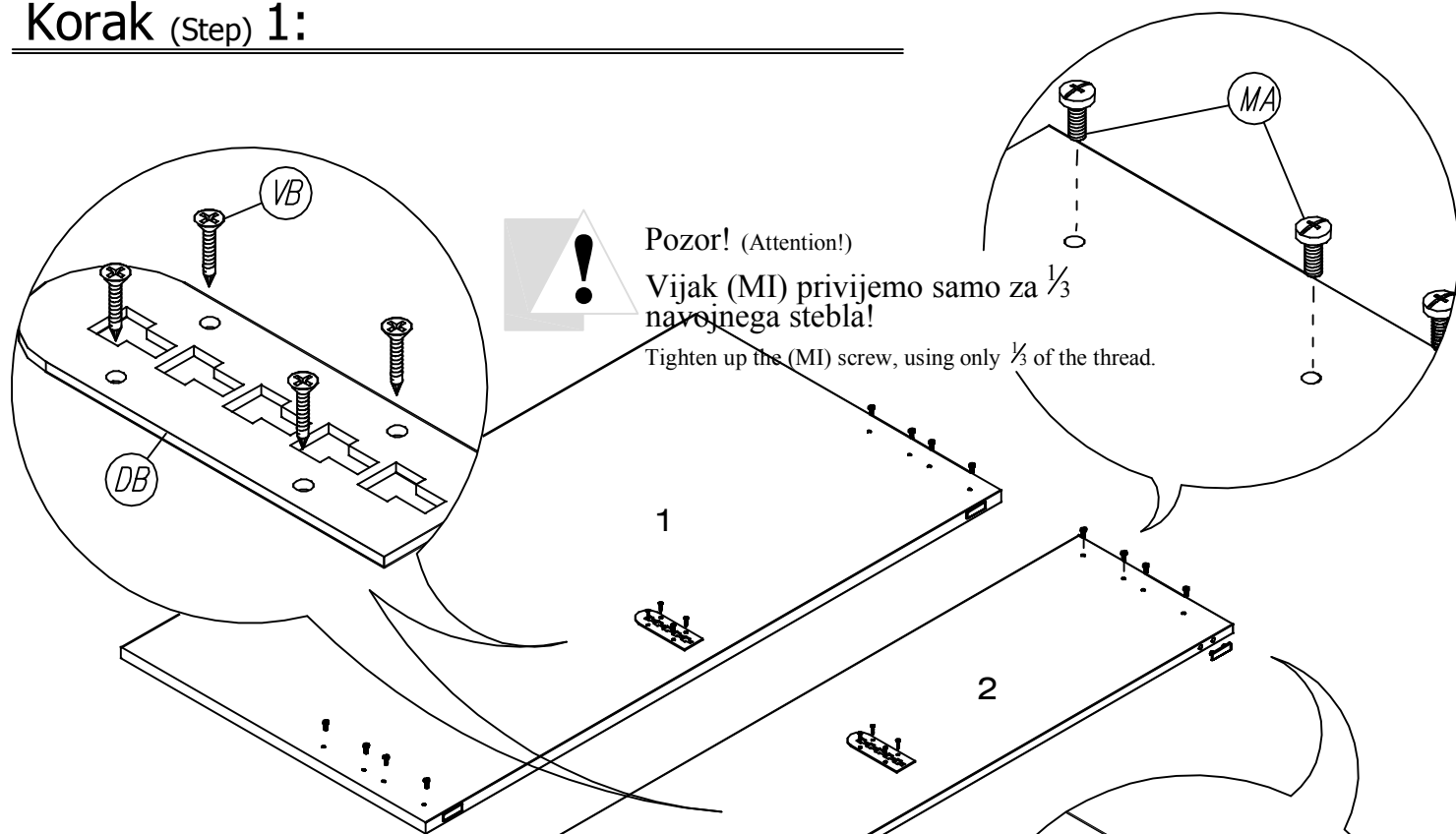

Korak (Step) 2:

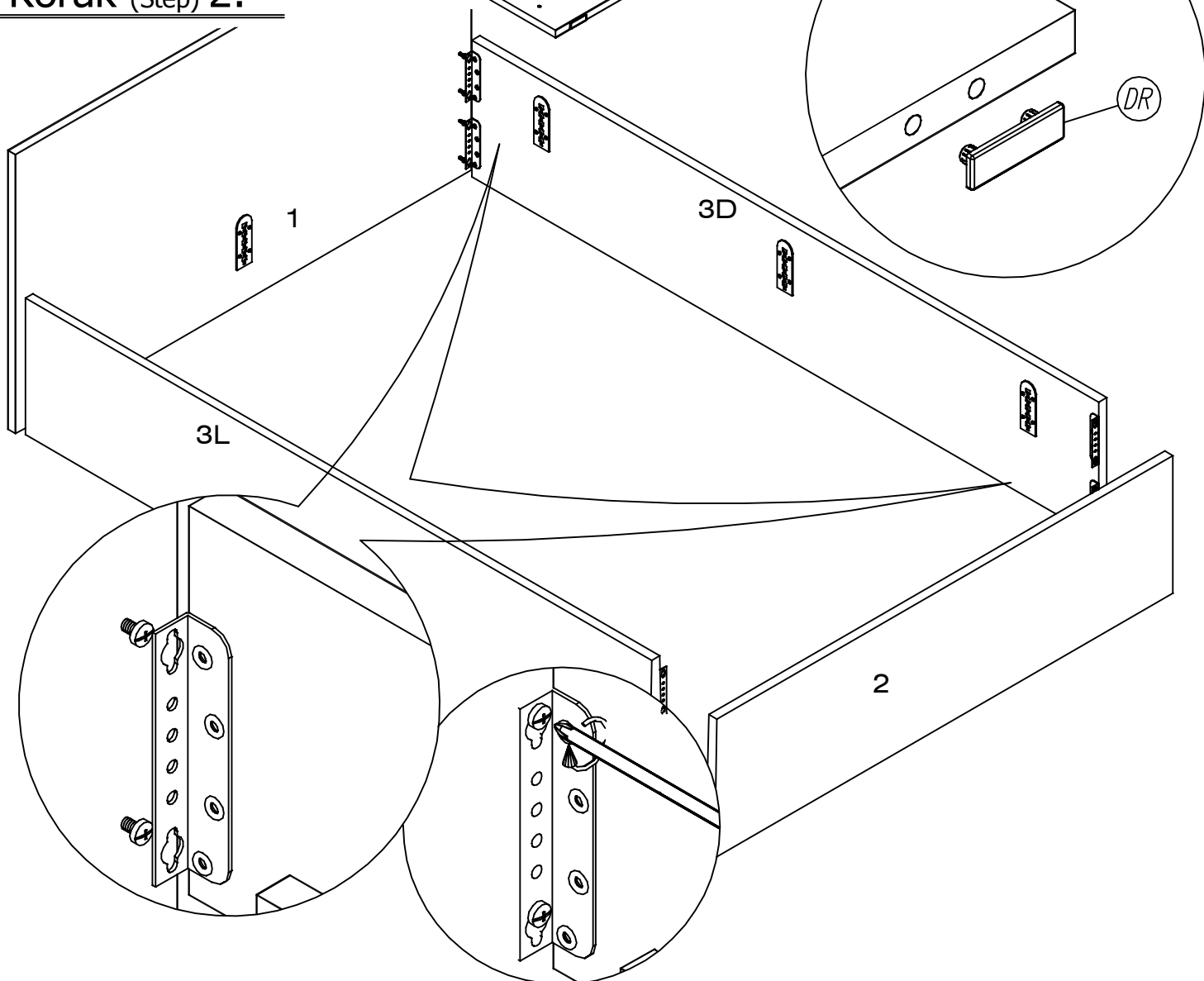

Korak (Step) 3:

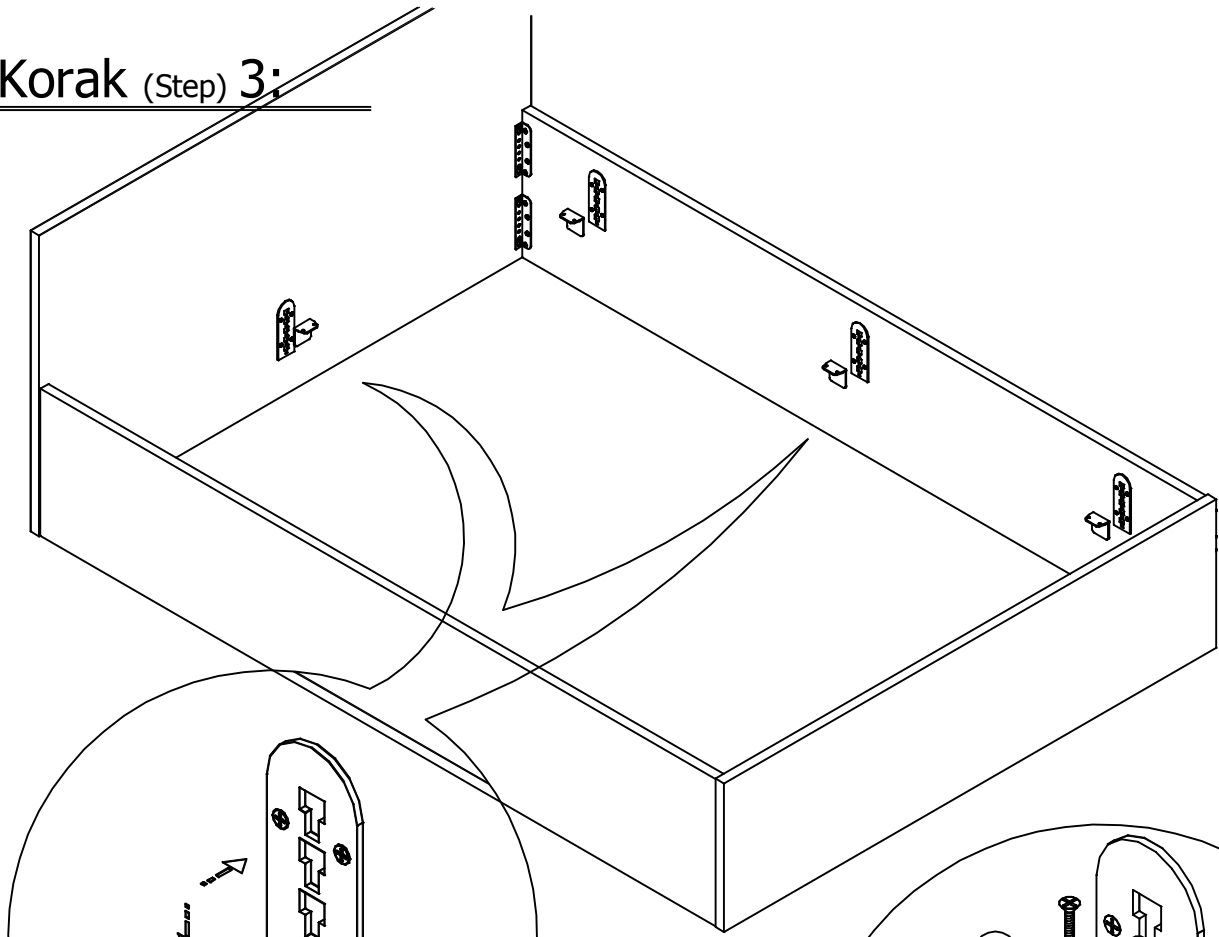

Korak (Step) 4:

