

NIVIA 240

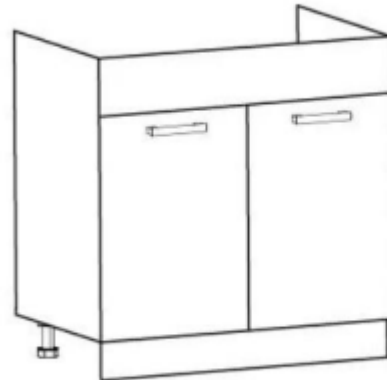

NIVIA G60W

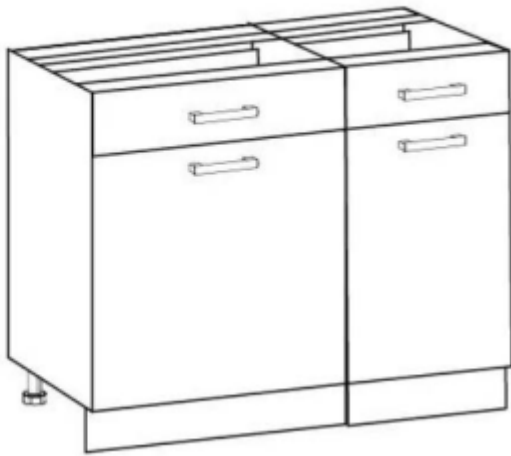
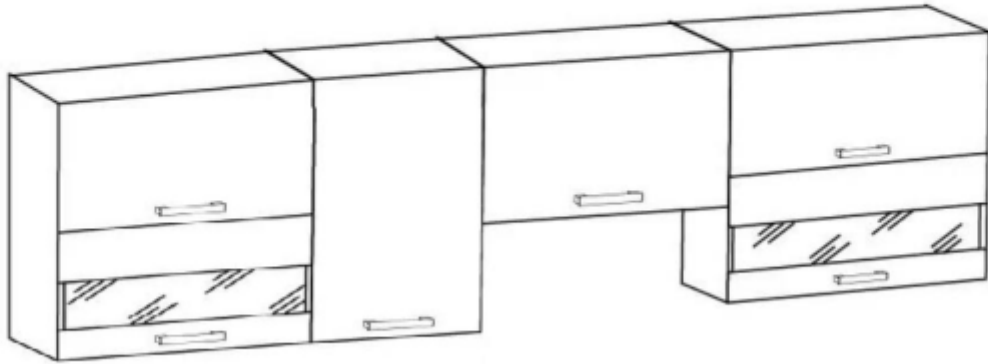
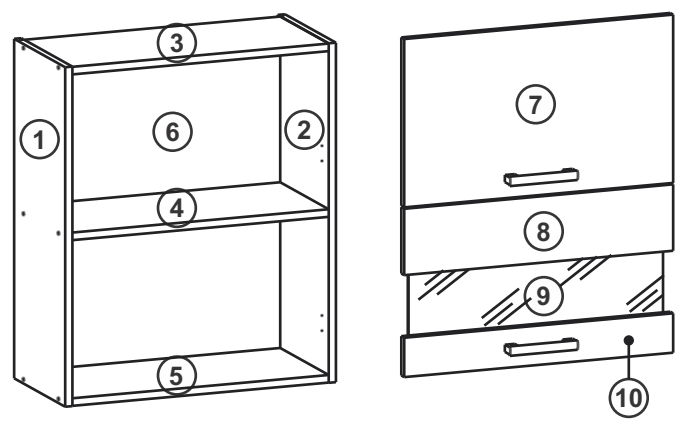
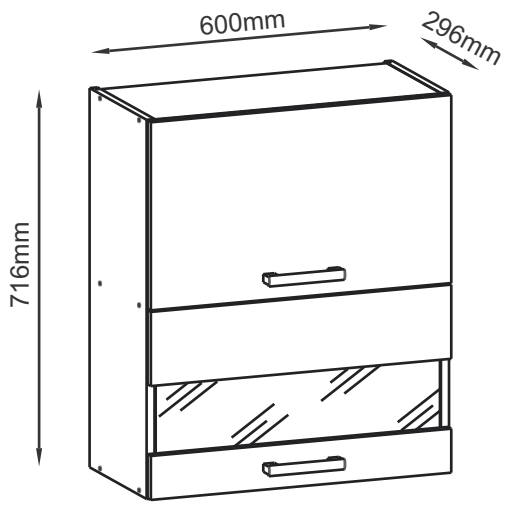

1x 4mm z1	12x Ø 6,3x50mm e27	12x Ø 12mm s3
12x Ø 8x30mm f1	2x Ø 35mm ab1	4x m5
2x n165	2x L=128/148mm c252	6x 10x10x15mm l2
14x Ø 4,2x16mm p21	8x Ø 3,5x16mm p51	4x Ø 4x25mm p26
2x 80x27x5mm j1	4x Ø 4x30 mm p30	2x M4 r3
		6x 10x6x10mm d6
		2x Ø 35mm ab2

A	B (mm)		C	D
1	716	280	16	x1 2/9
2	716	280	16	x1 2/9
3	568	266	16	x1 2/9
4	568	266	16	x1 2/9
5	568	280	16	x1 2/9
6	582	704	2.5	x1 2/9
7	596	355	16	x1 9/9
8	596	140	16	x1 9/9
9	564	192	4	x1 9/9
10	596	83	16	x1 9/9

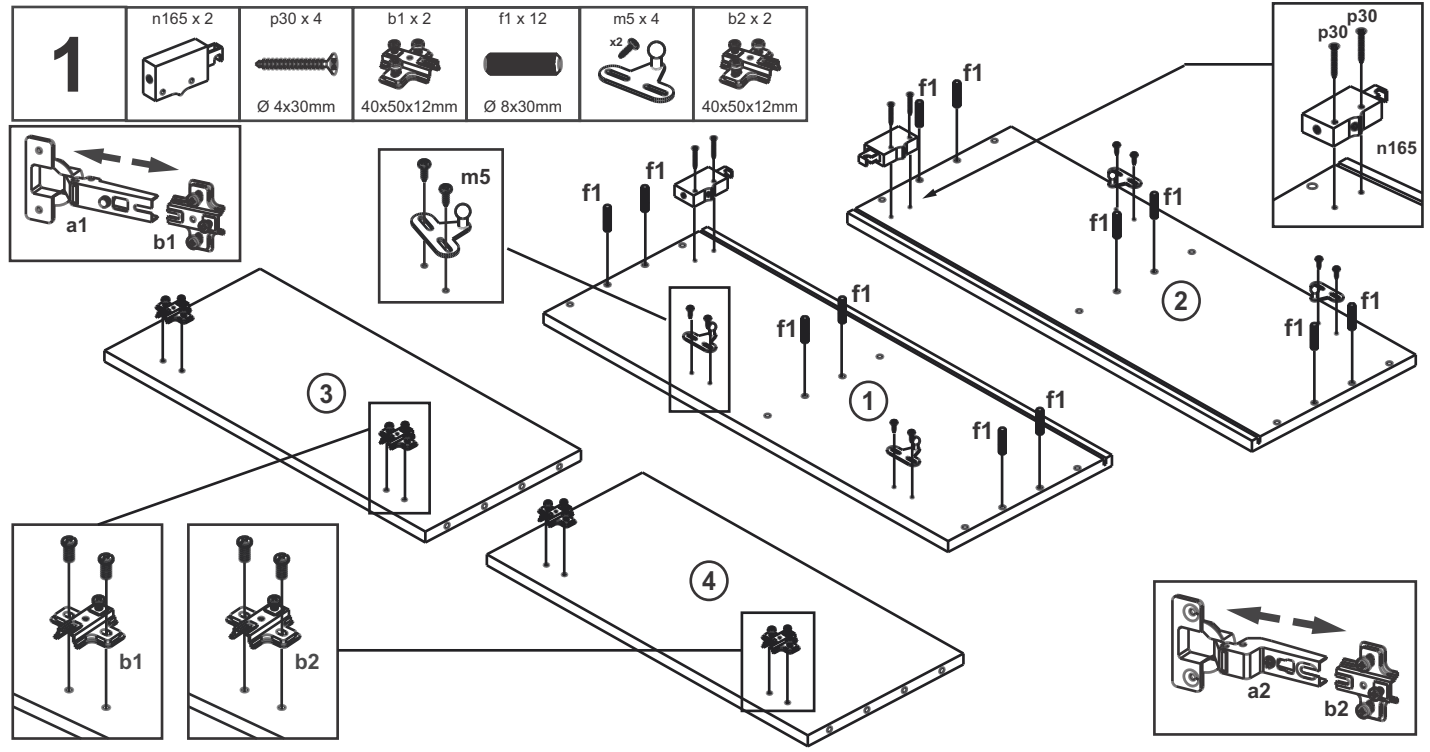
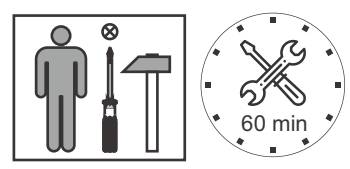

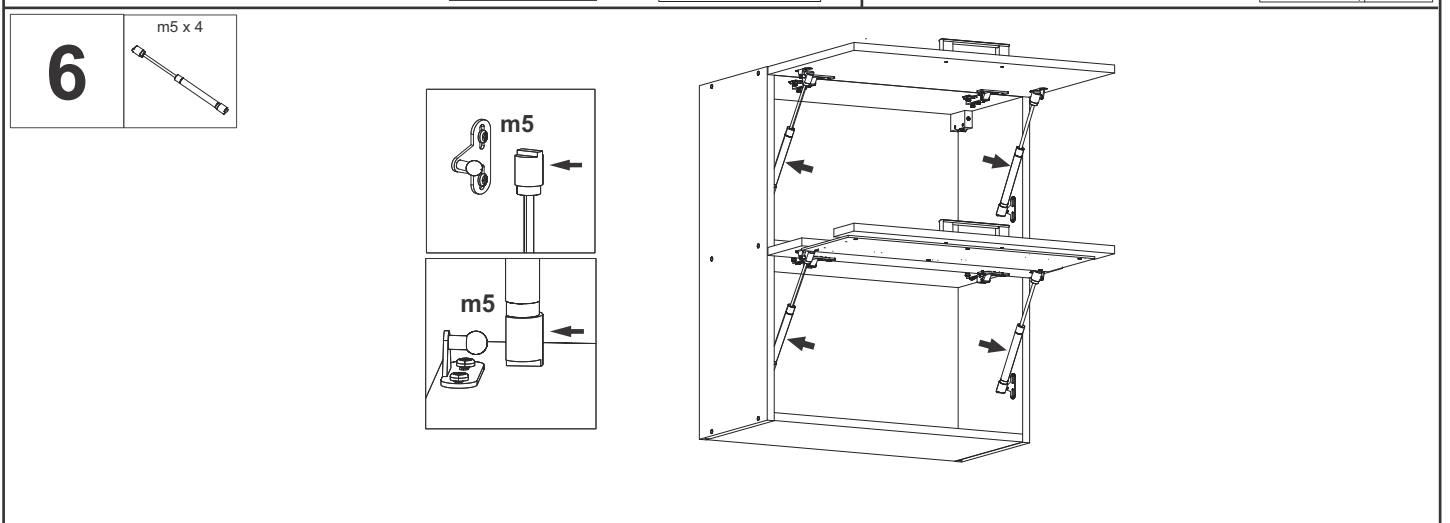
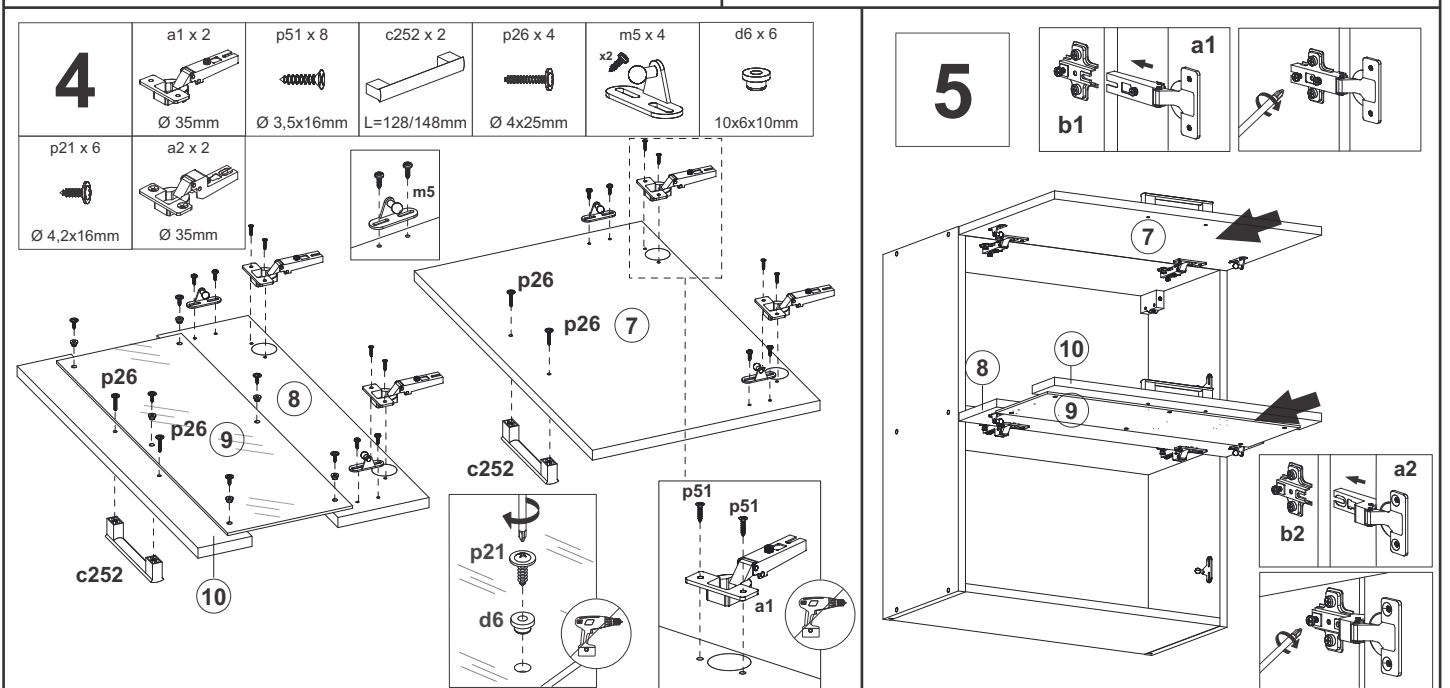
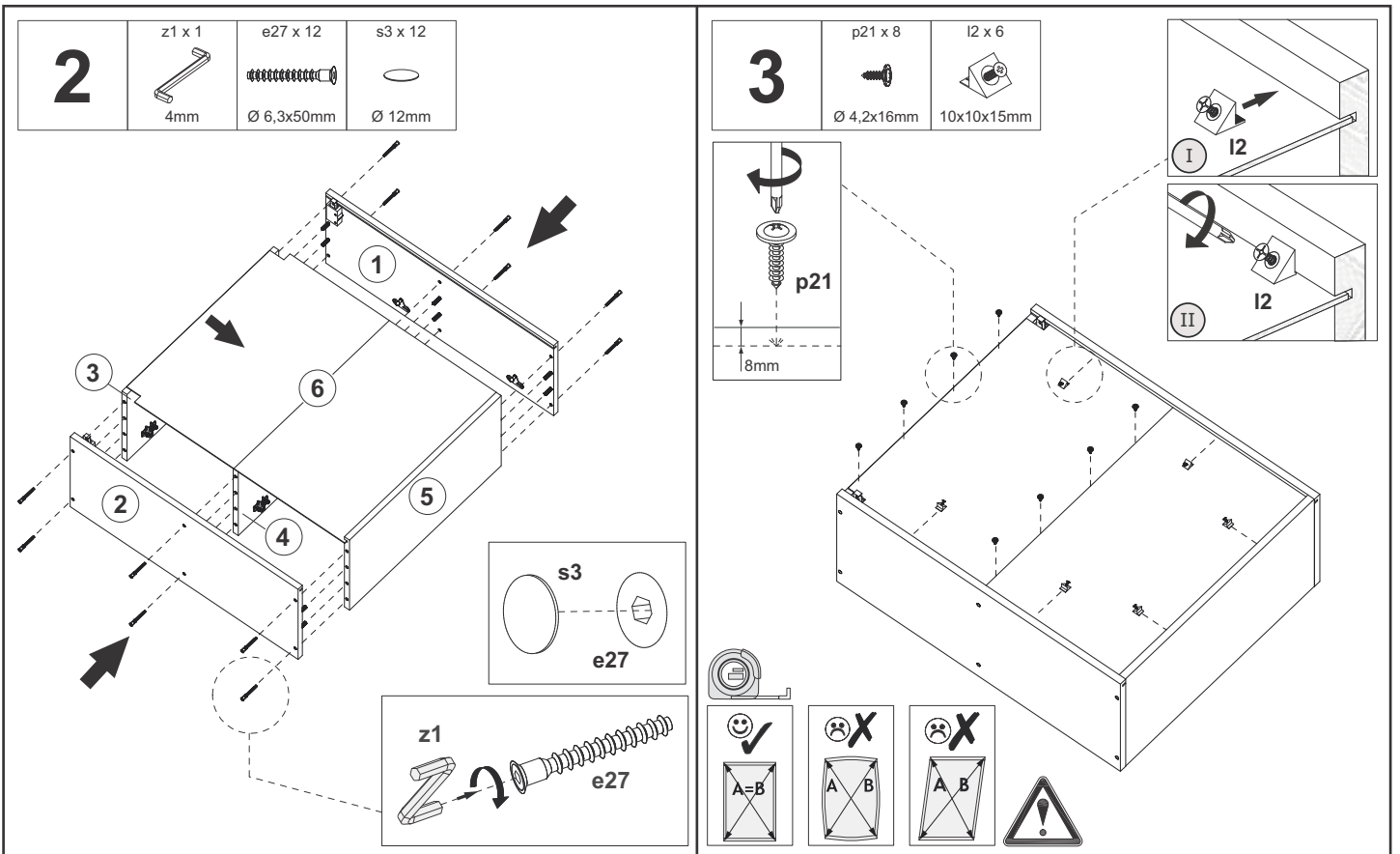

7

j1 x 2
80x27x5mm

