

980336

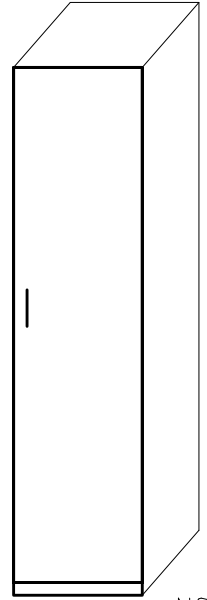

NSP 43 ZB

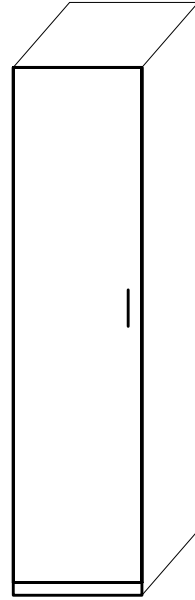

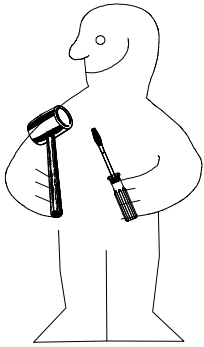
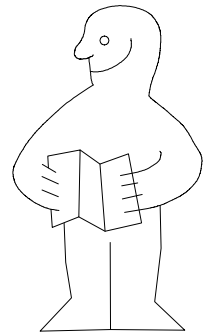
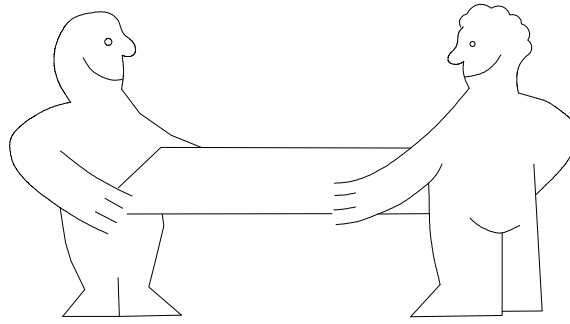
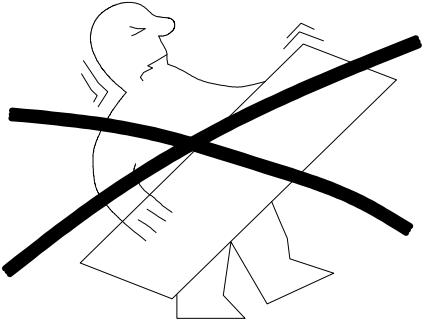

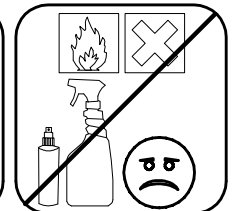
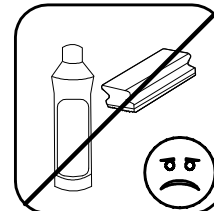
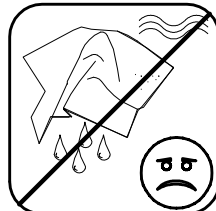
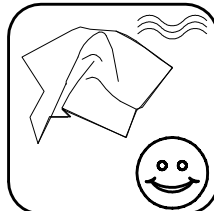
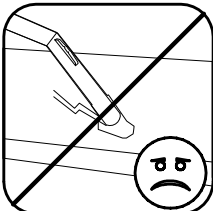
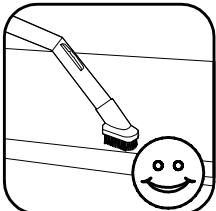
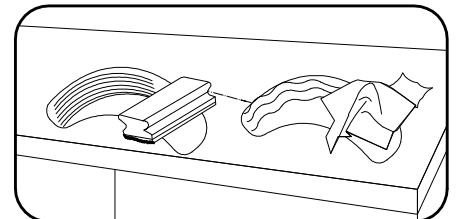
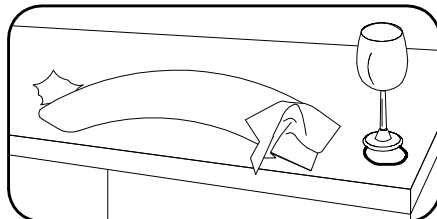
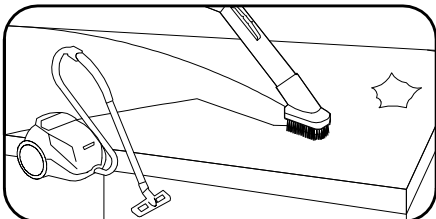
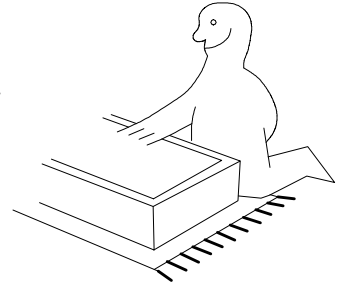
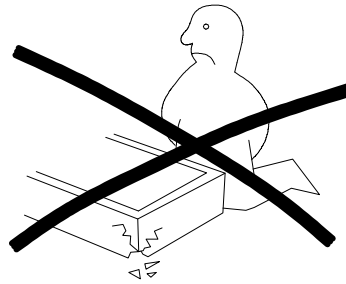
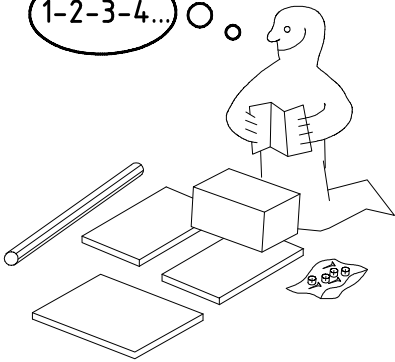
1-2-3-4... ○





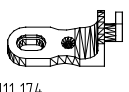
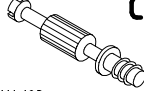

980336

06.04.16 / -

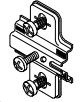
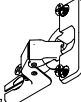
04 16 | 1/8

 111 102	A 8x
 111 610	L7 12x
 111 174	J1 2x
 111 103	C 8x

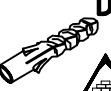
 112 268	M 3x
 112 267	N 3x
 M6 x 11 mm	T6 2x
 3,5 x 15 mm	G1 2x

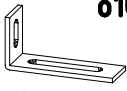
 111 618	D20 1x
 6 X 60 mm	G16 1x
 4 X 15mm	SP15 1x
 111 052	o10 1x

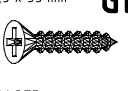
 3,5 x 35 mm	G14 4x
121 375	

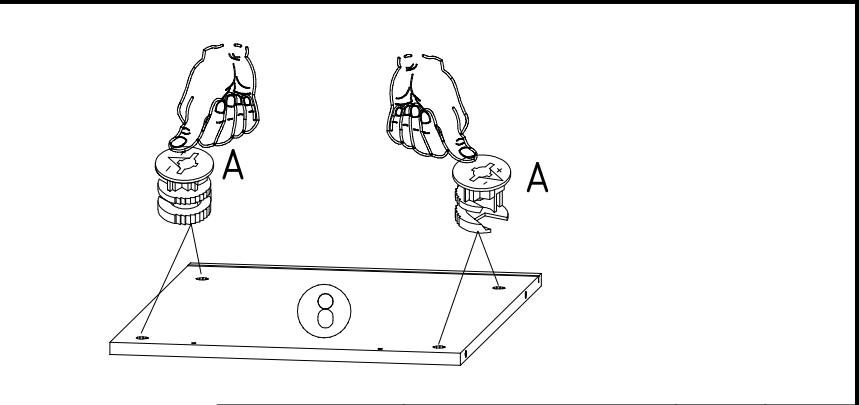
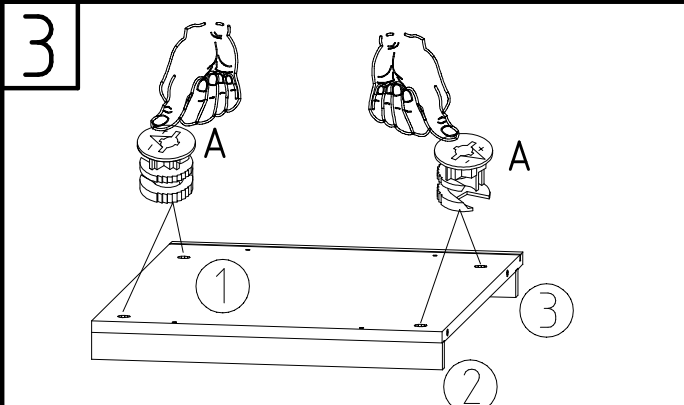
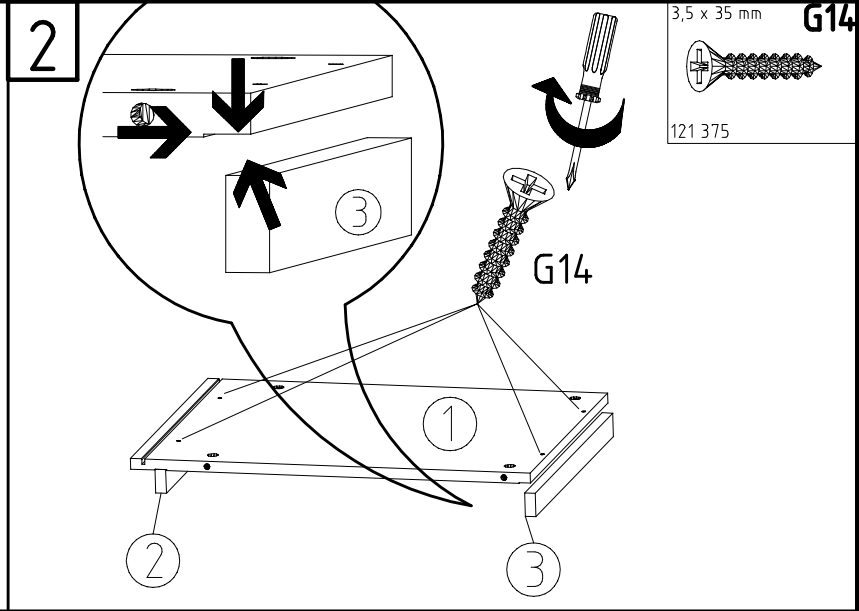
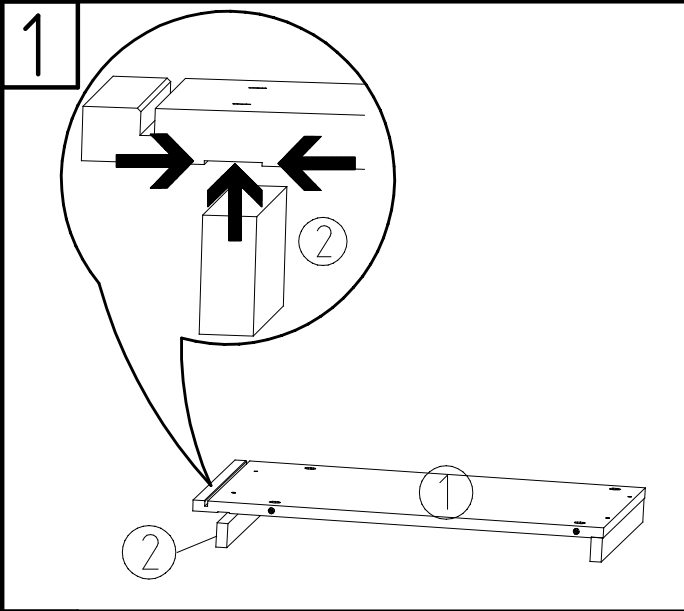
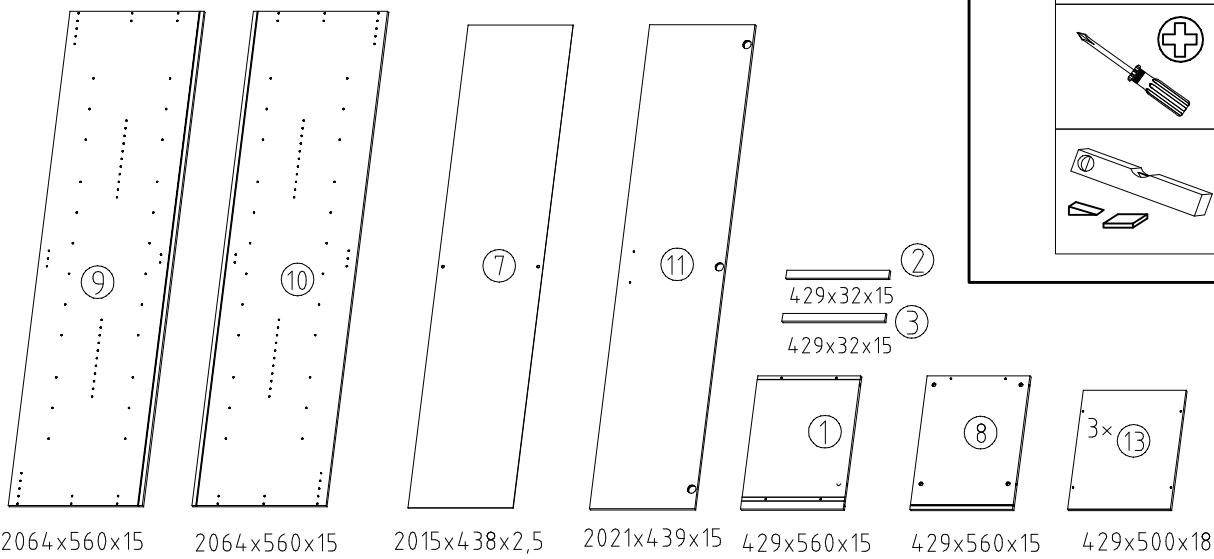
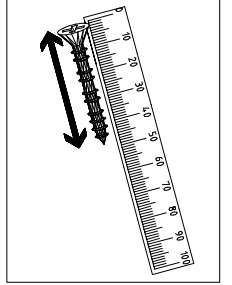
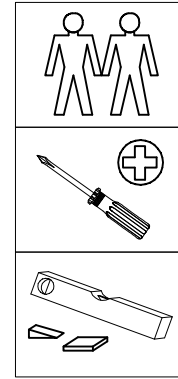
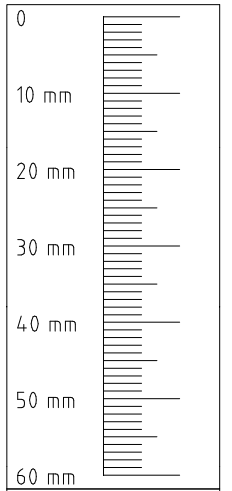

4

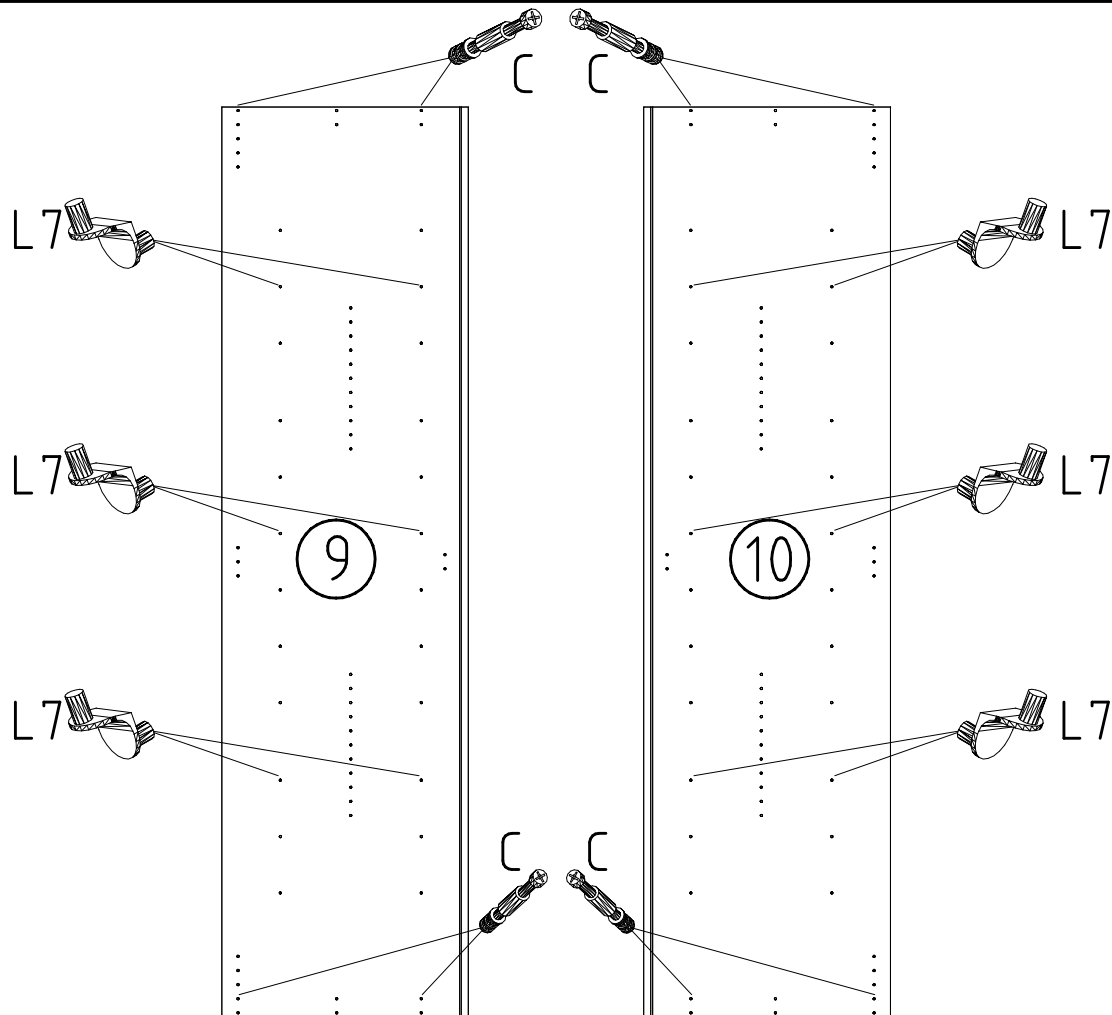

5

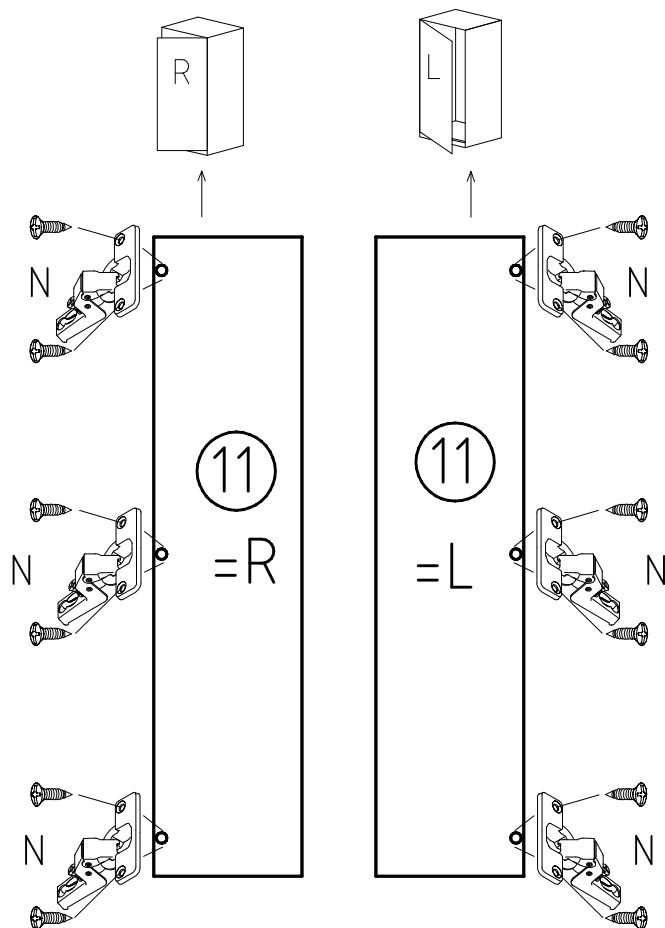

L7

111 610

+

C

111 103

+

N

112 267

6

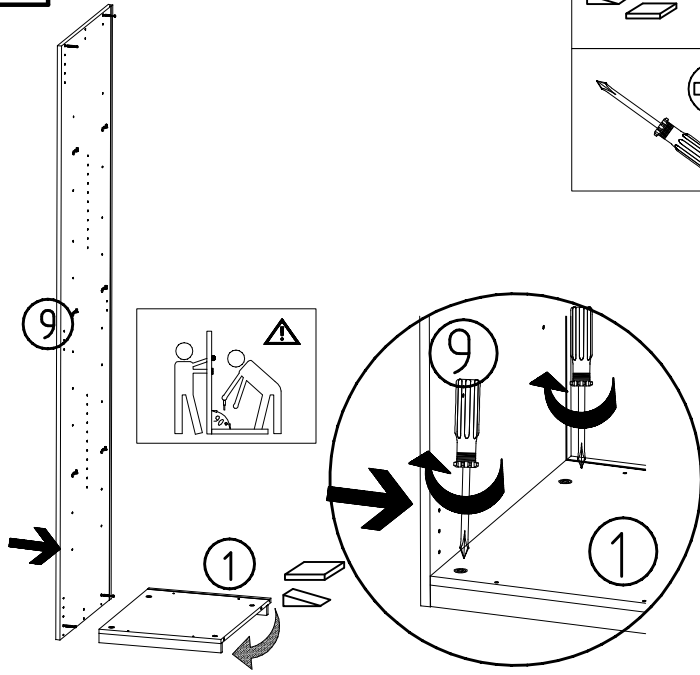

7

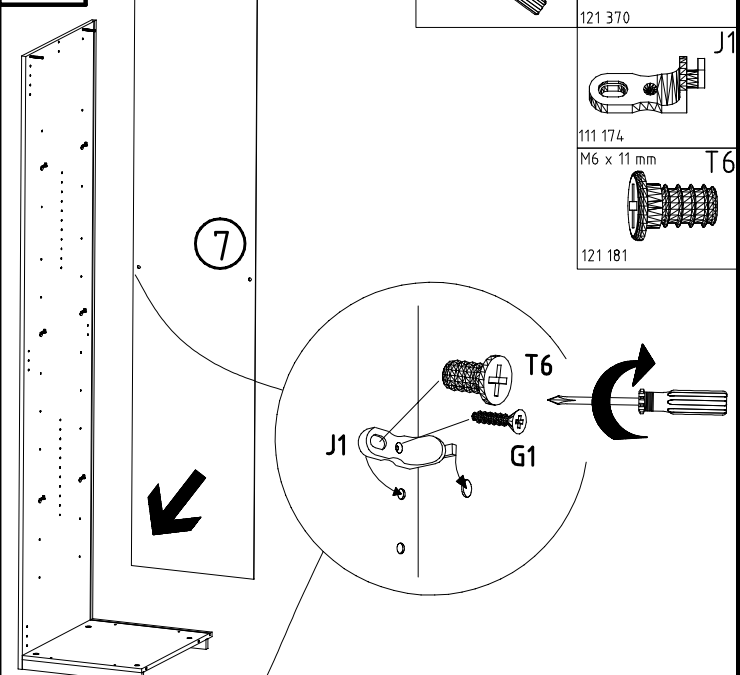

- 3,5 x 15 mm **G1**
121 370
- J1**
111 174
- M6 x 11 mm **T6**
121 181

8

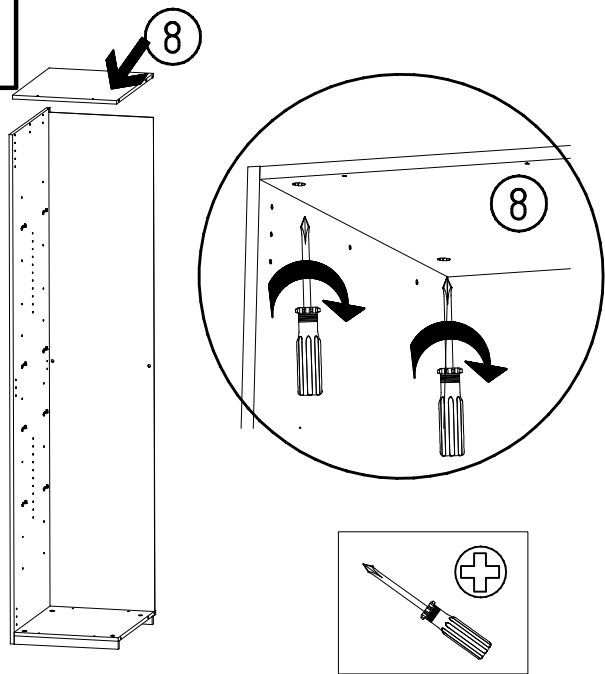

9

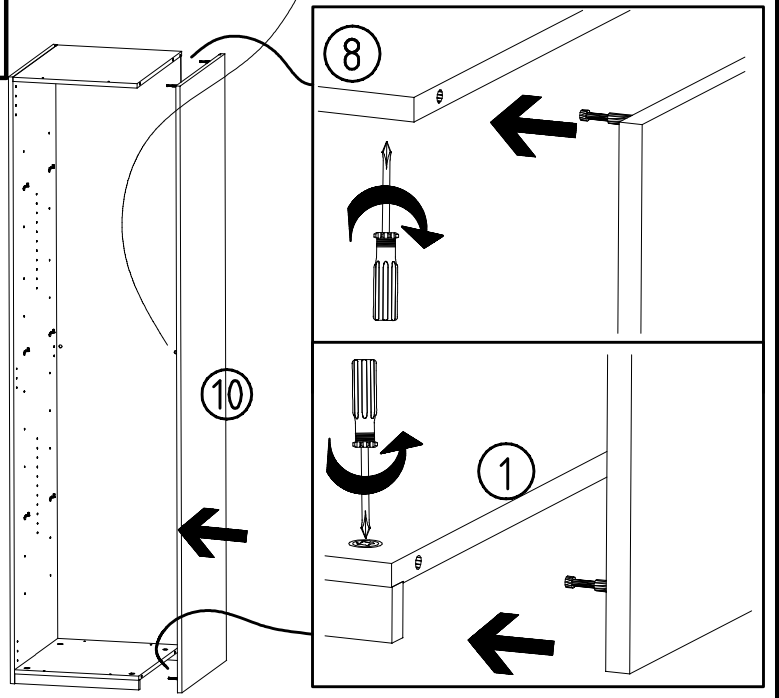

10

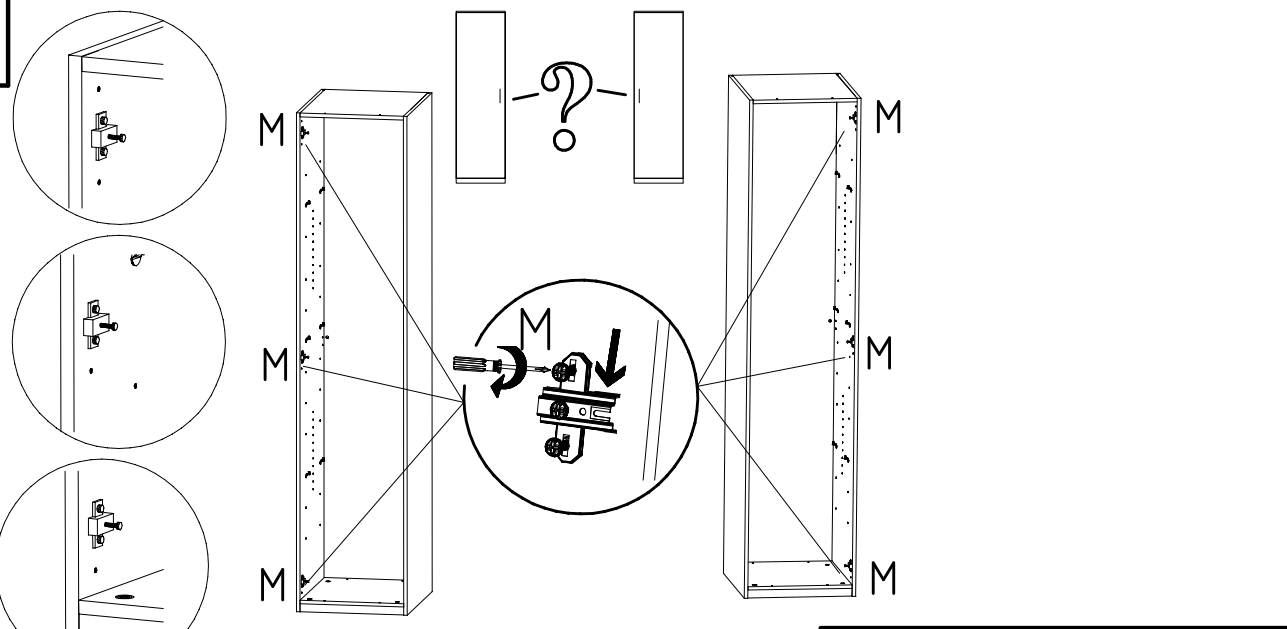

- M**
112 268
-

11

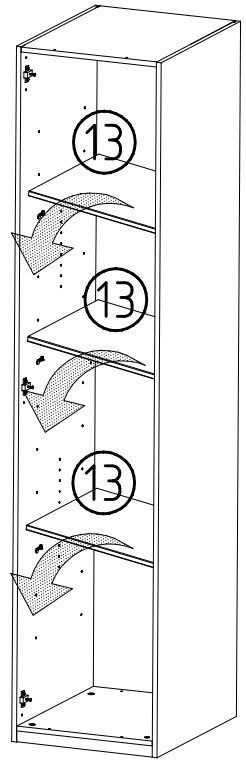

12

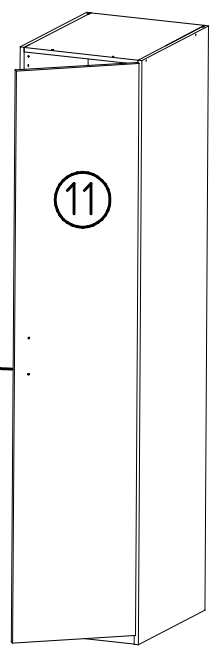
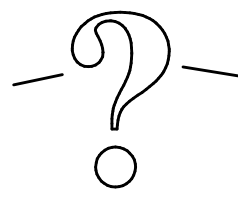
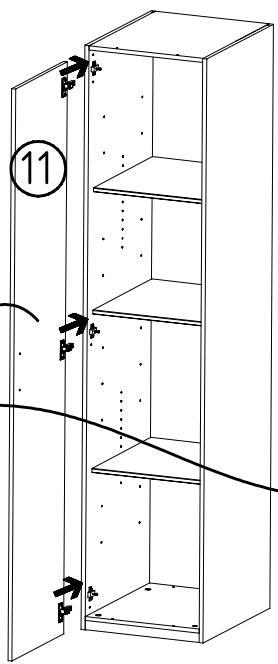
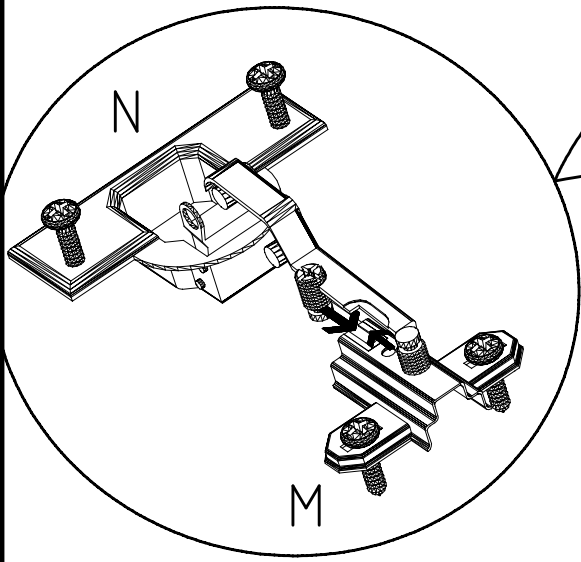
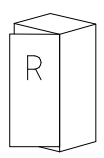
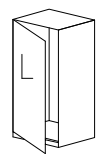
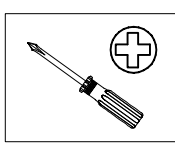

13

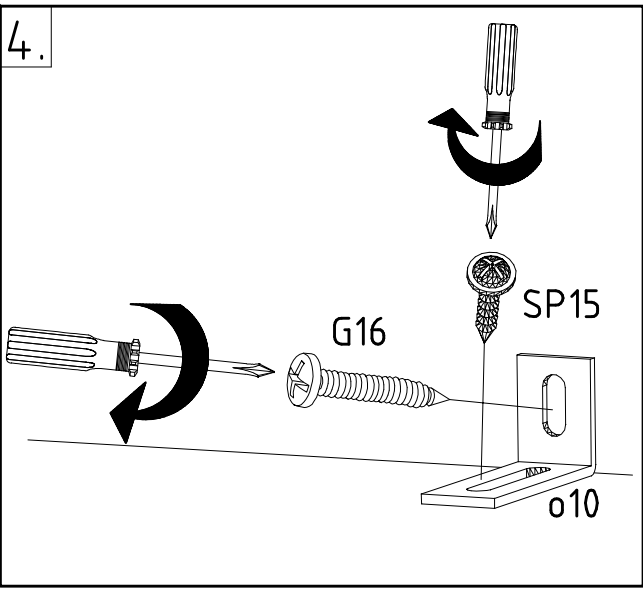
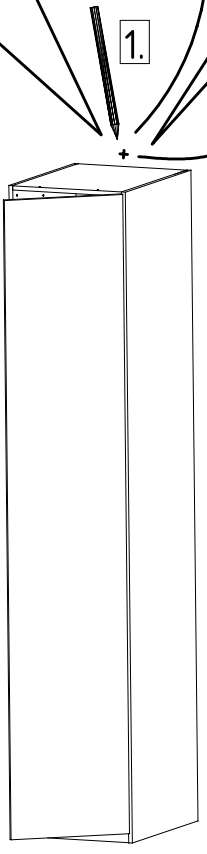
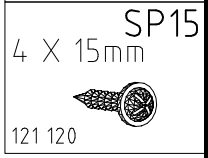
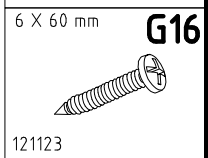
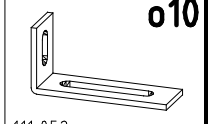
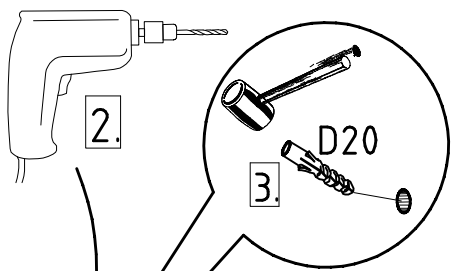
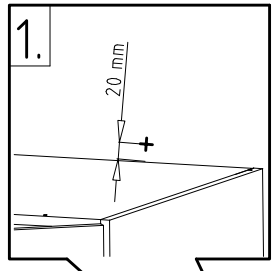
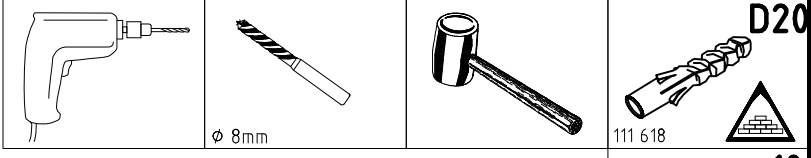
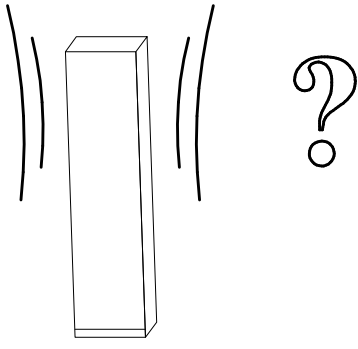

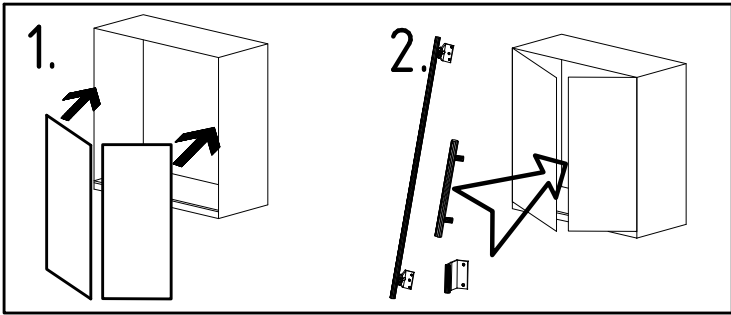
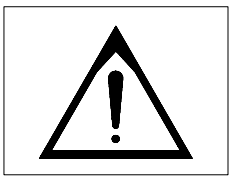

3,5 x 15 mm 121 370	G1	4,0 x 12 mm 122 625	G56
------------------------	----	------------------------	-----

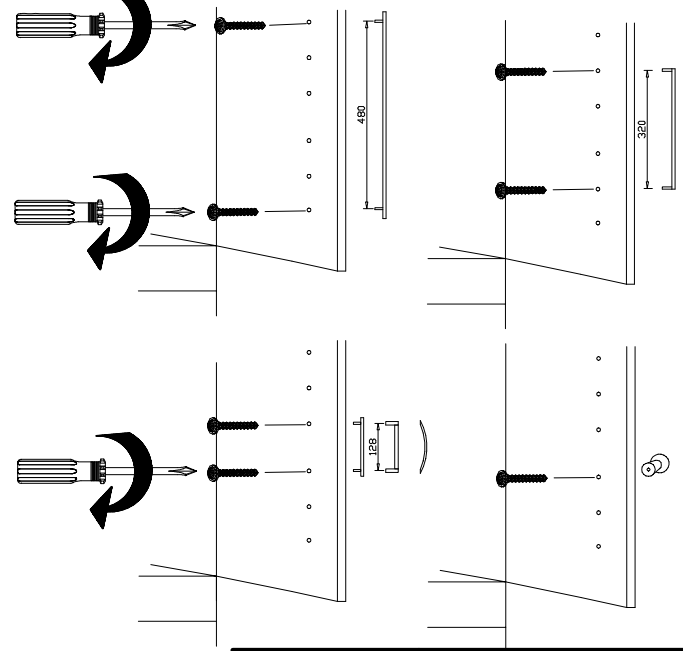
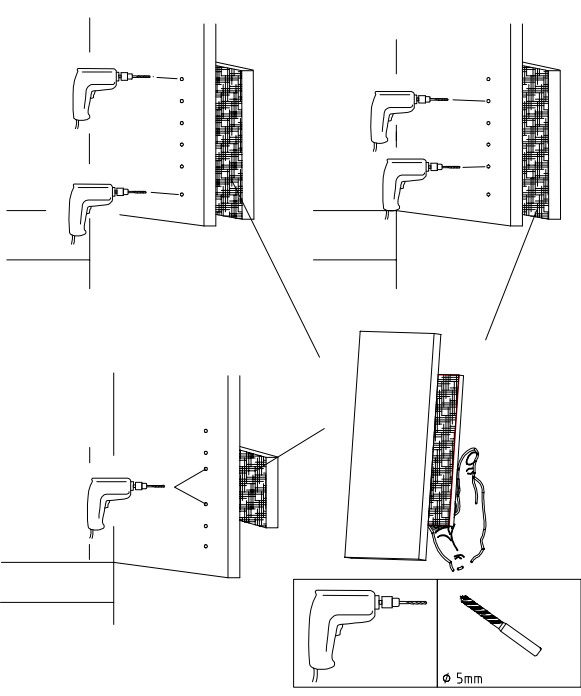
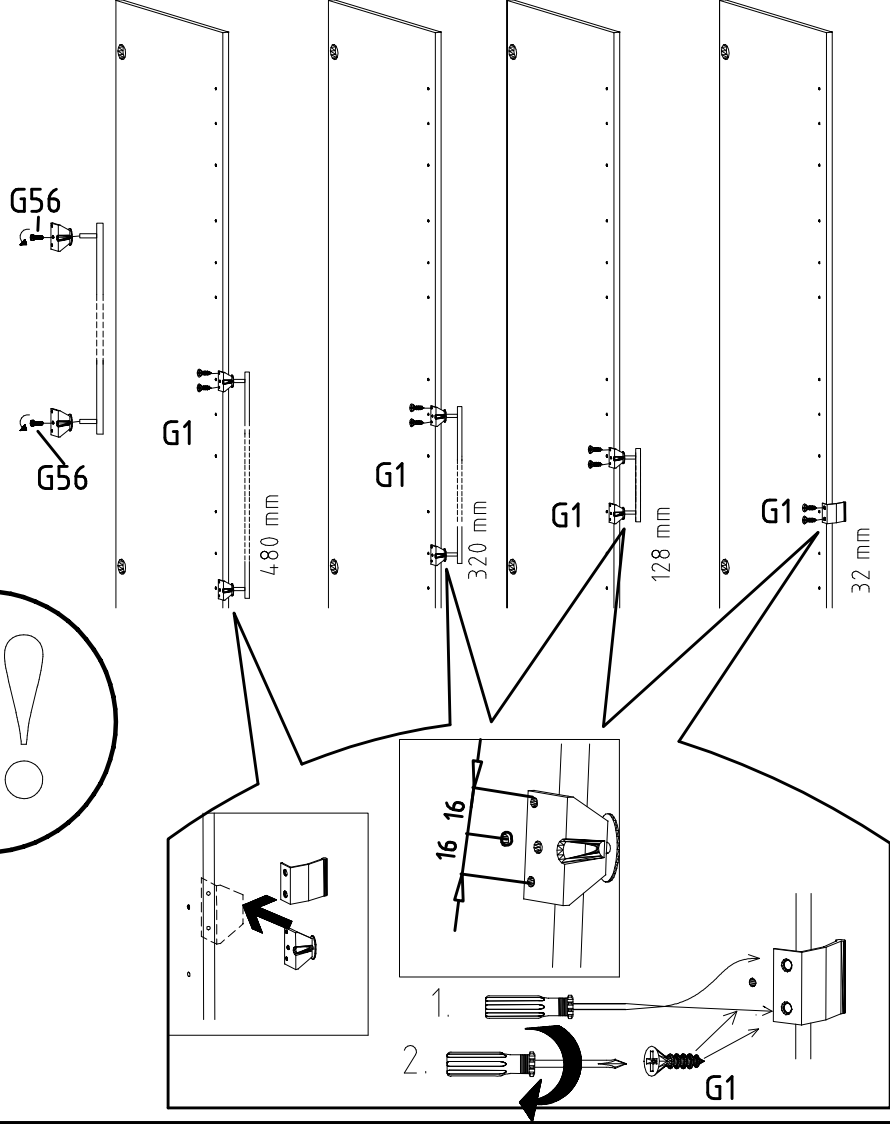
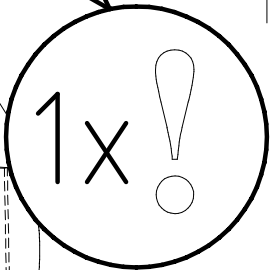
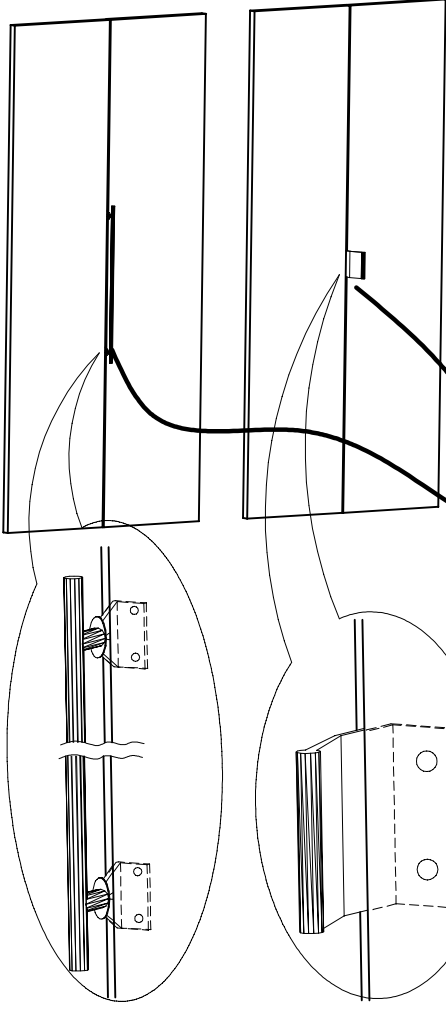

SP27
4 X 27mm
122620
4,0x22
G49
122 609

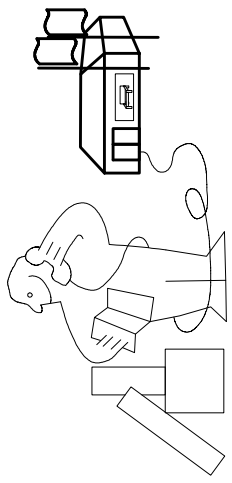
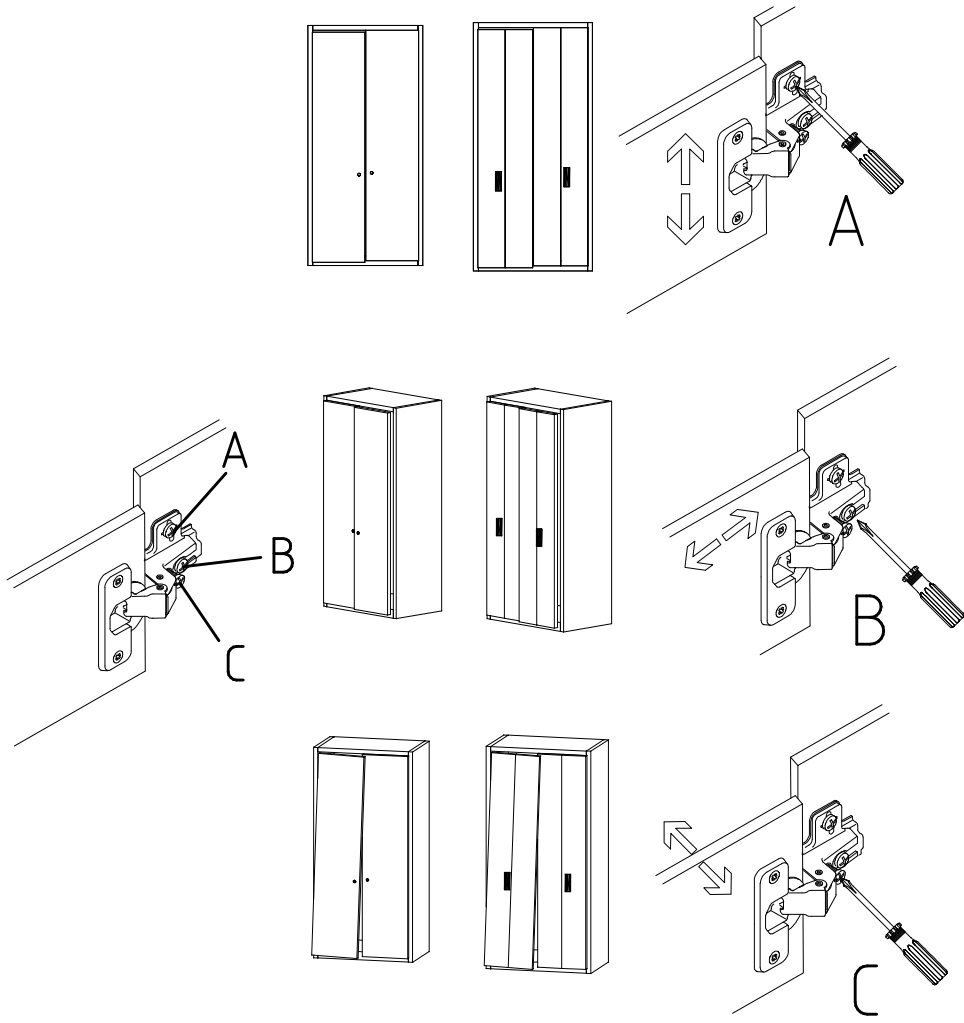

Modell/Model/Modèle

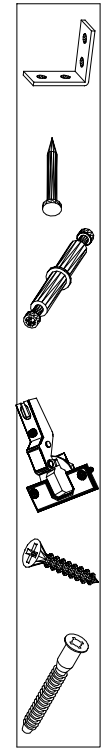
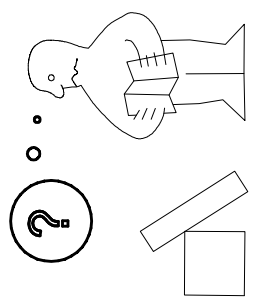
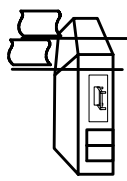
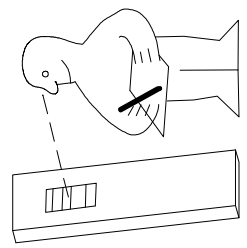

<121 370>	< G 1 >	<4x>

Änderungen die dem technischen Fortschritt geschuldet sind, behalten wir uns vor!
 Bei nicht vorschriftsmäßiger und/ oder nicht fachmännischer Montage wird bei Personen- und/ oder Sachschäden keinerlei Haftung übernommen.

WIMEX Wohnbedarf/ Import Export Handels GmbH/ Postfach 1407/ 49112 Georgsmarienhütte/ Germany
 Tel.:(+49) 054-01 8598 16/17 Fax.:(+49) 054-01 8598 33 Mail: service_H@wimex-online.com

104P-Nr. / 104P-No. 150X-Nr. / 150X-No. Auftrag/Order-No. / No. de Commande

23203 **30110XY** 104

Kunde MAX MUSTERMANN
Customer
Client

Kommission / your order reference / votre reference

3377 MINDEN

Dekor / Decor Decor / Modell / Modele

F99 **SAMPLE**

F99842 SCHWEBETUERENSCHRANK 250 CM H 216CM
PLANKENEICHE NB + RAU STEEL
PLANKENEICHE NACHBILDUNG

202320301107241476000001

Paket / Package / Paquet

414760

SOCKEL

Paket 1 von 8 Colli Kommission 10

HSP-SMT BOD 50 TEXT/TEX SOCKEL 32 FRESH TV / LF 104
SO-BOD TEXT RASTEX/ ZNBOD D18MM TX KLSTA

Montage - Anleitung Laenge 520,0 OBEREN
KS-64 Breite 568,0 OBEREN

SOCKEL32 KLEB

Bei Warenauslieferung für Rückgabe beachten!
En cas de livraison veuillez retourner le bordereau d'envoi.

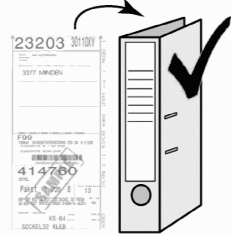

OBEREN 5 30/19 HAUT 23.08.19 OBEREN 1 1. JABOVE OBEREN

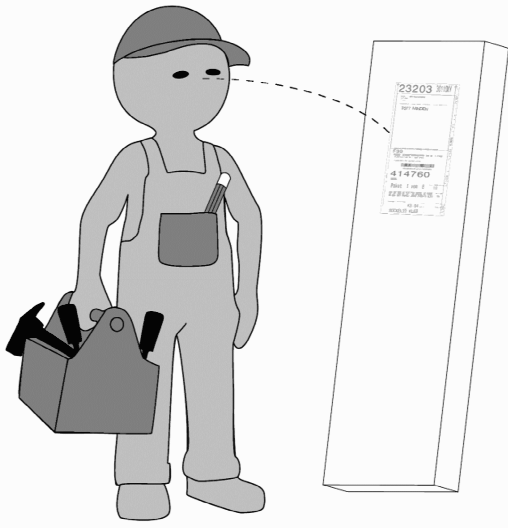

WIMEX Wohnbedarf
Import Export Handelsges mbH & Co. KG
Werner-von-Siemens-Str. 35
D-49124 Georgsmarienhütte - Germany

SAMPLE **23.08.19**
Modellname Produktionsdatum
Model Date of manufacture

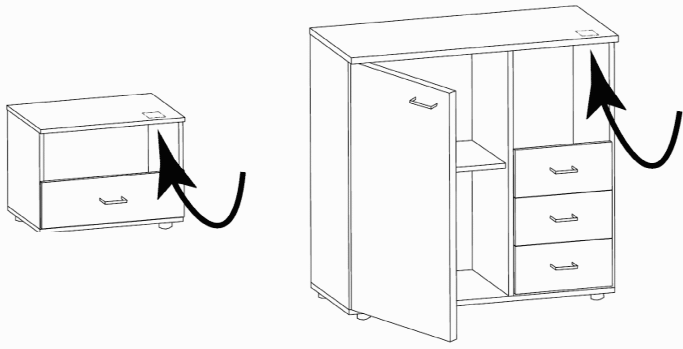
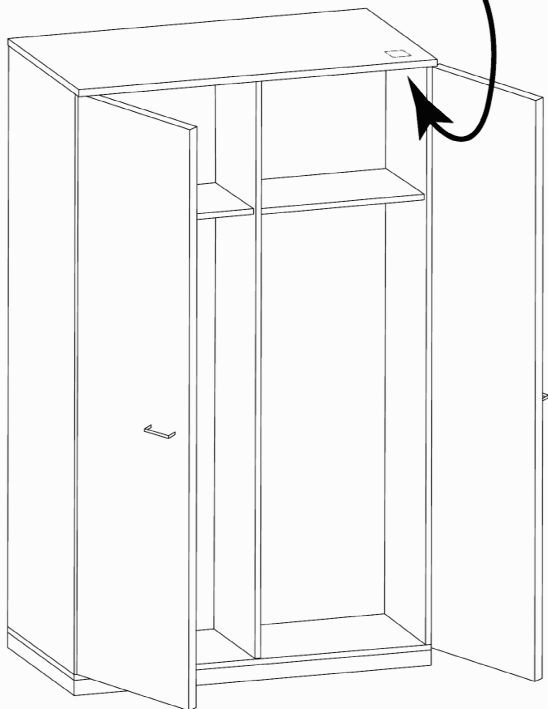
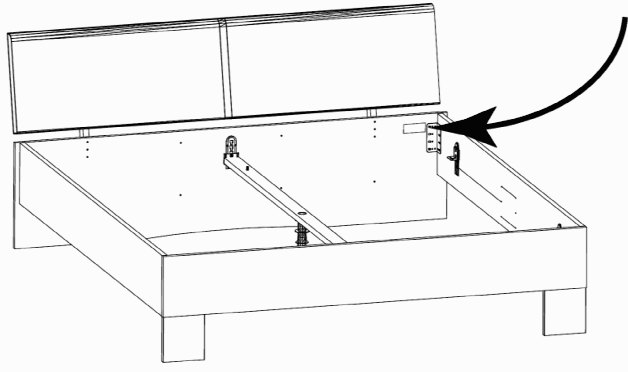

980005

