

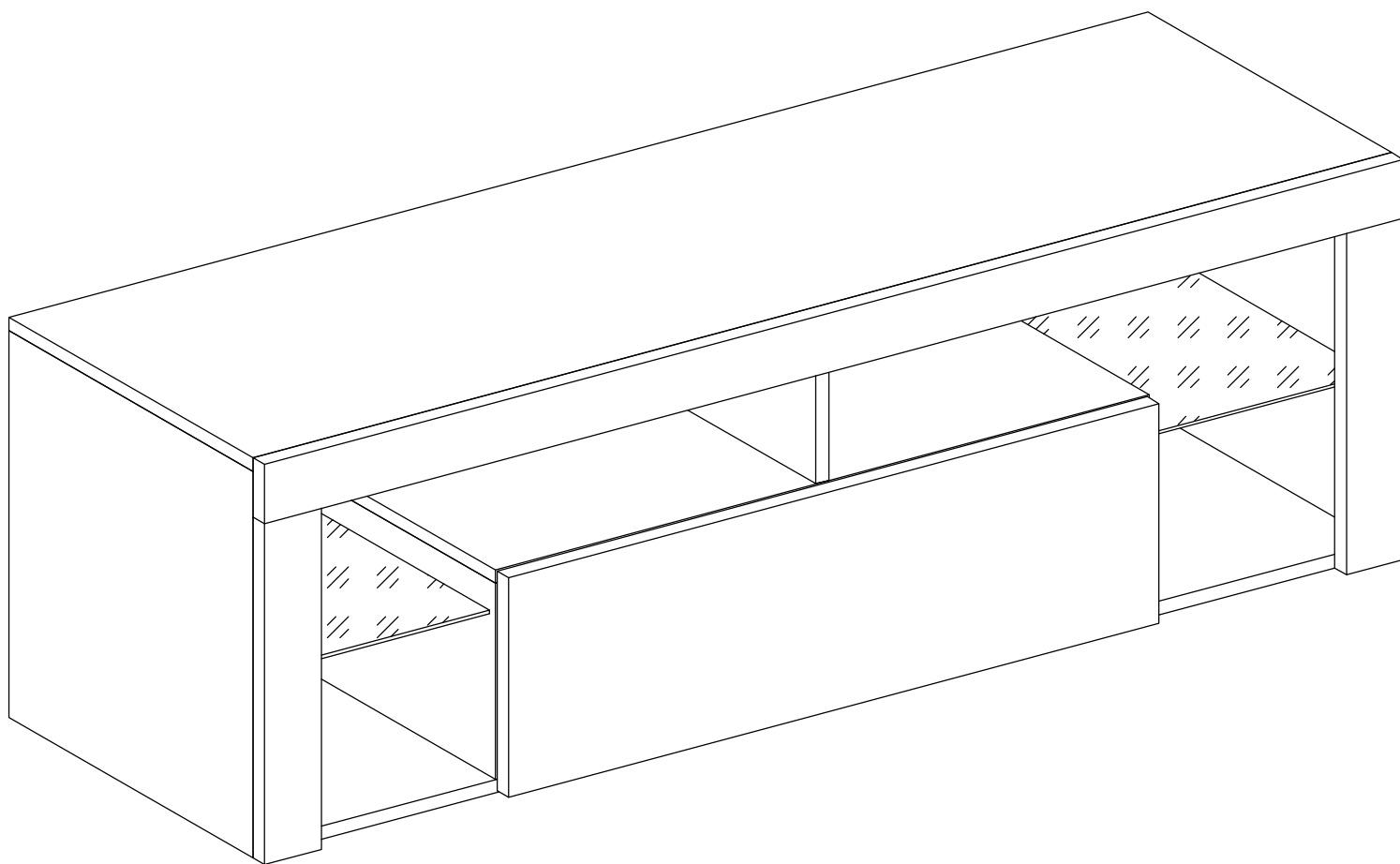

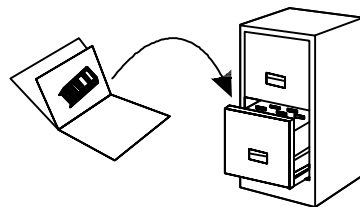

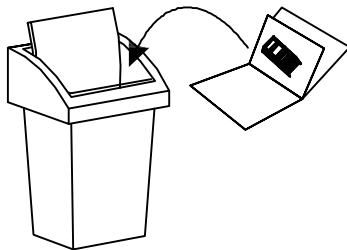

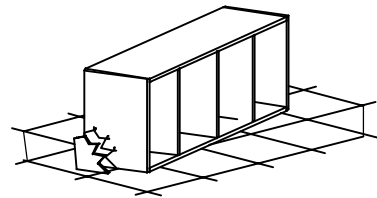

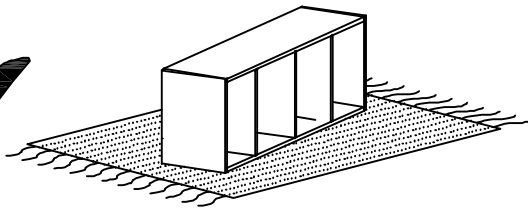
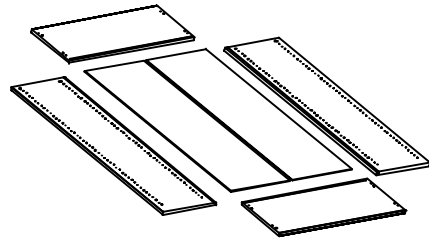
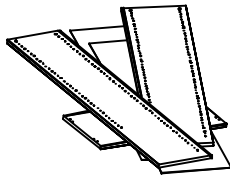
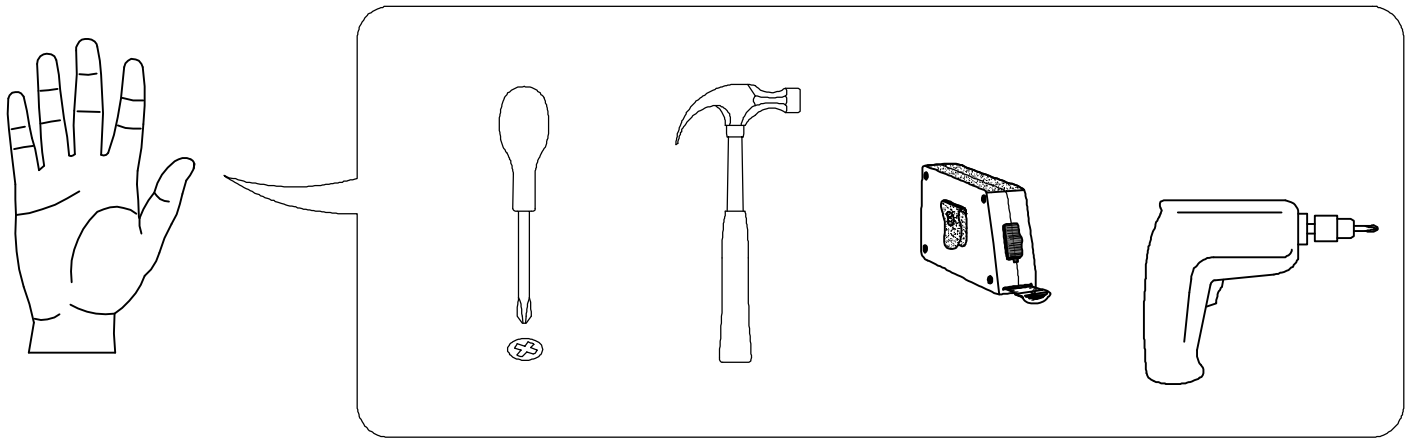



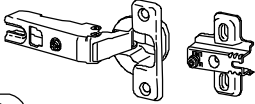

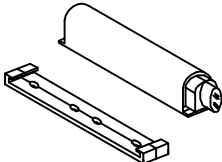
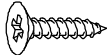
# Vegas

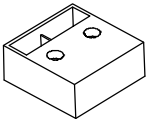

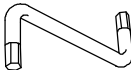
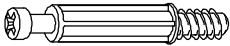

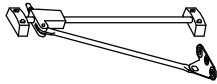
 <b>A1</b> 8*30mm x20	 <b>B</b> x6	 <b>B1</b> 6,3*50mm x6
 <b>L1</b> x2	 <b>R3</b> 14*25mm 0.02kg	 <b>F5</b> 6,3*13mm x4
 <b>N9</b> x1	 <b>E4</b> 3,5*16 x14	 <b>E18</b> 4,5*35mm x12
 <b>K4</b> x6	 <b>A2</b> 8*50mm x4	 <b>R4</b> x1
 <b>C1</b> 6*43mm x22	 <b>D1</b> 15/16 x22	 <b>N4</b> R+L x1
 <b>E3</b> 3*20mm x8	 <b>D</b> $\phi$ 20mm x22	 <b>J4</b> x8

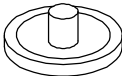
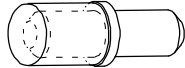
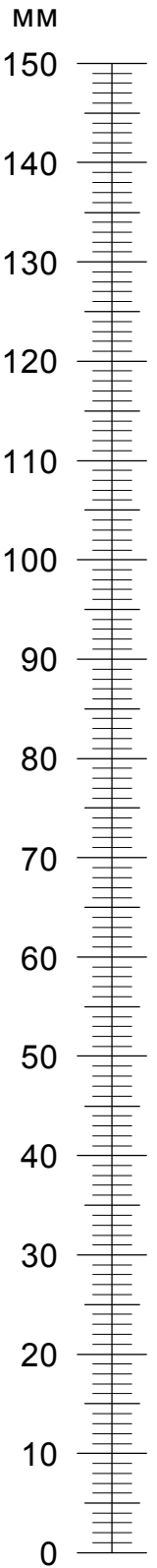

No	a*b	x	No	a*b	x
1L	459x334	1	6	194x334	1
1R	459x334	1	7	282x326	2
2L	233x334	1	8	800x261	1
2R	233x334	1	9	405x70	2
3	1400x334	1	10	1400x70	1
4	1368x334	1	11	800x261	1
5	804x334	1			

Vegas

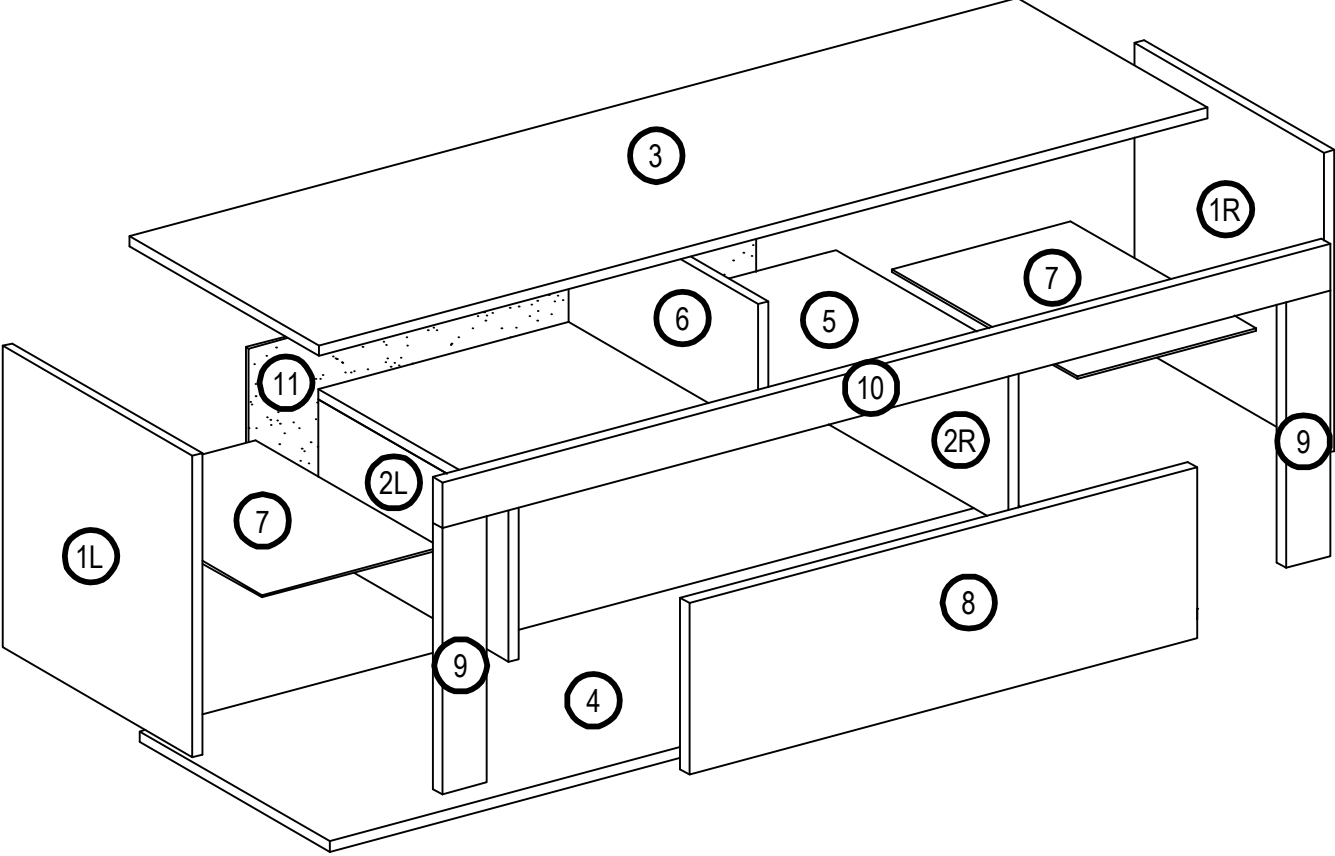

# 1

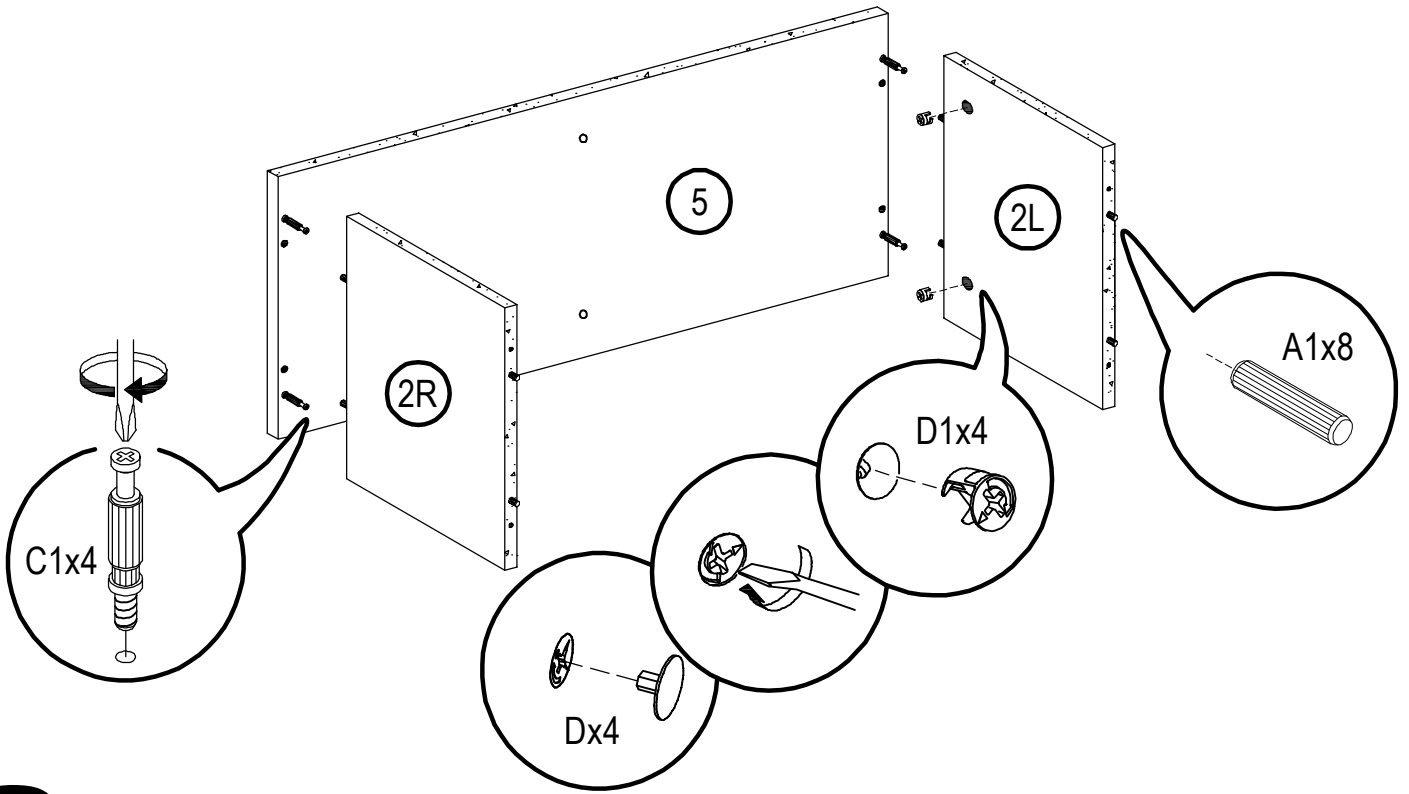

# 2

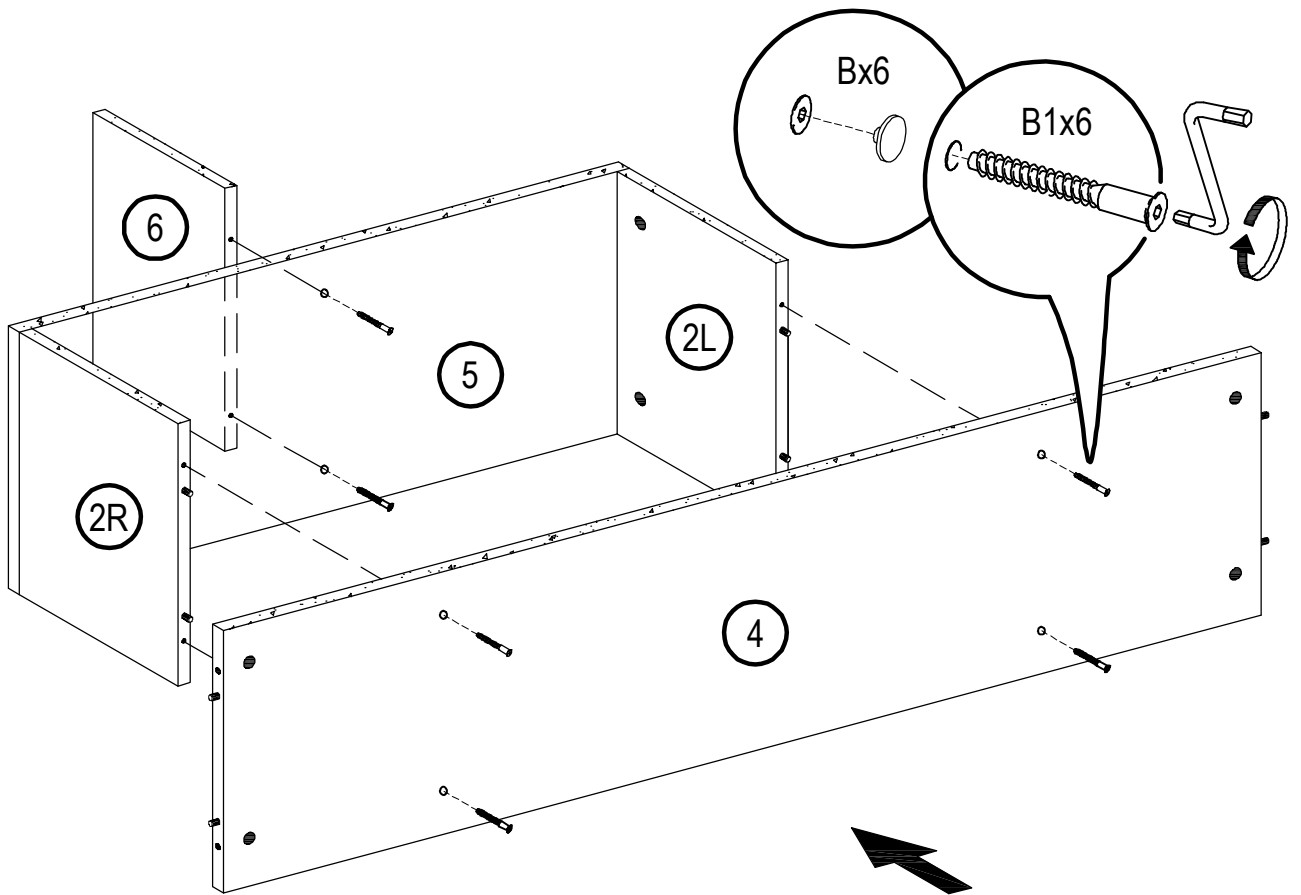

# 3

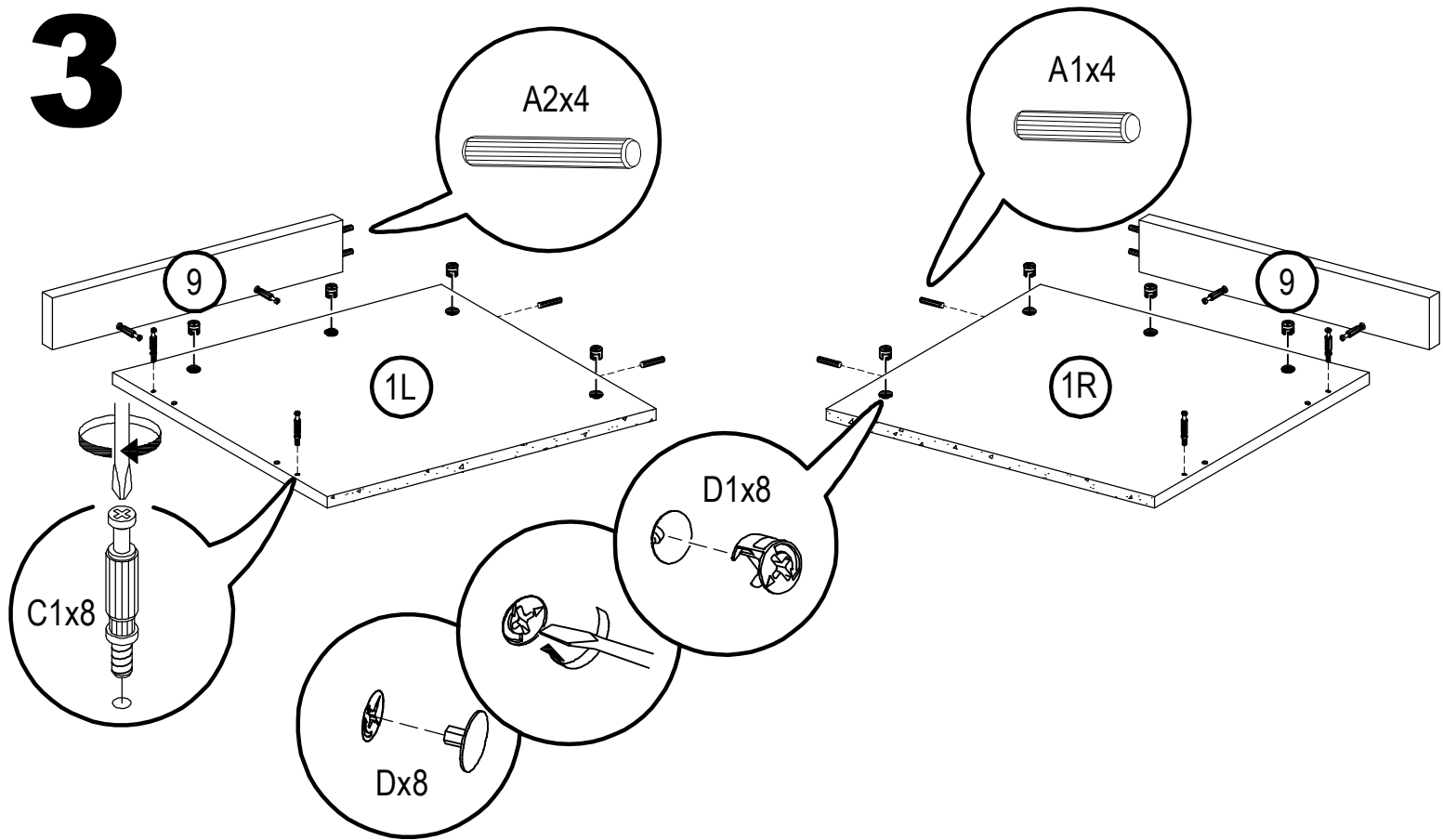

# 4

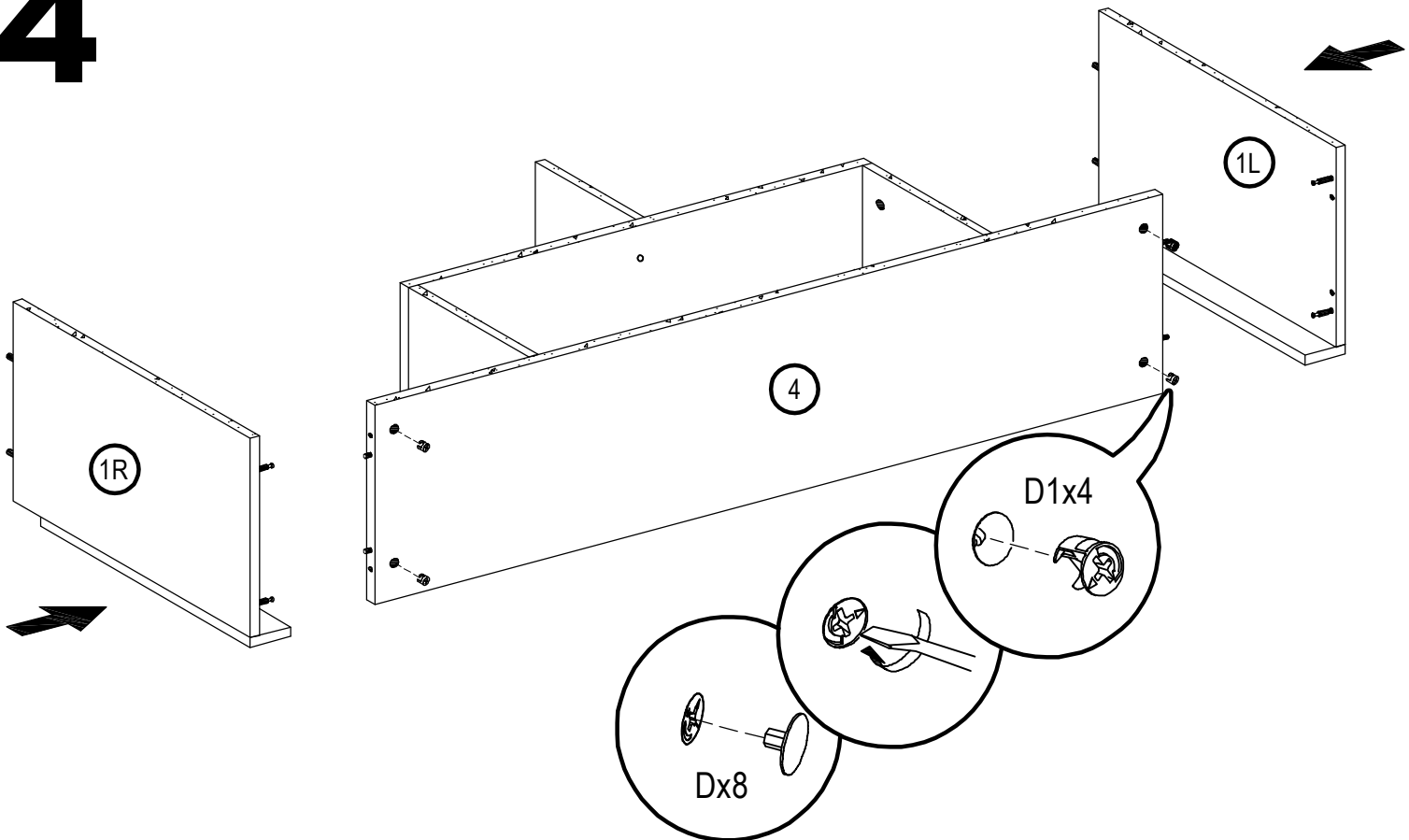

5

A2x4

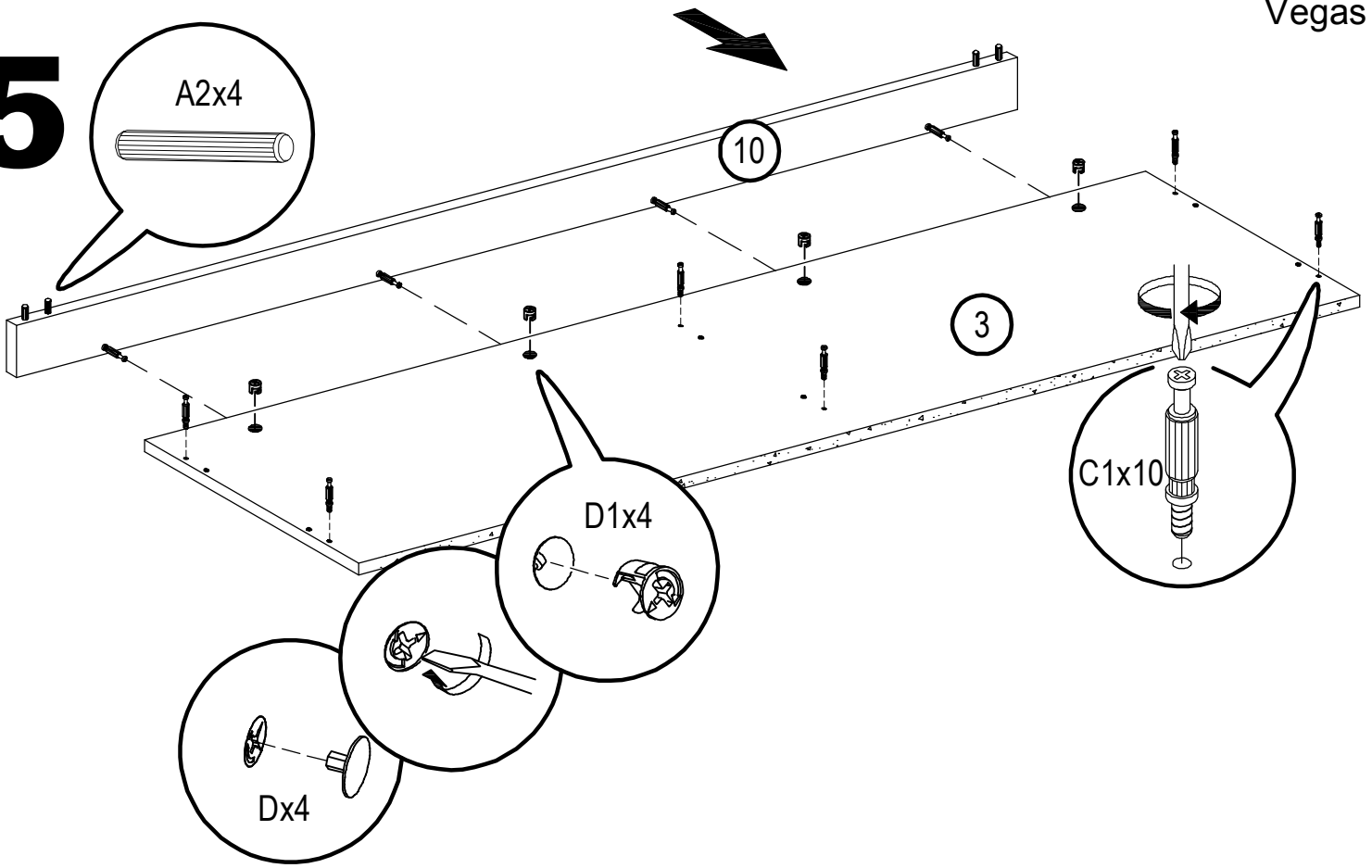
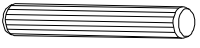

6

C1x6

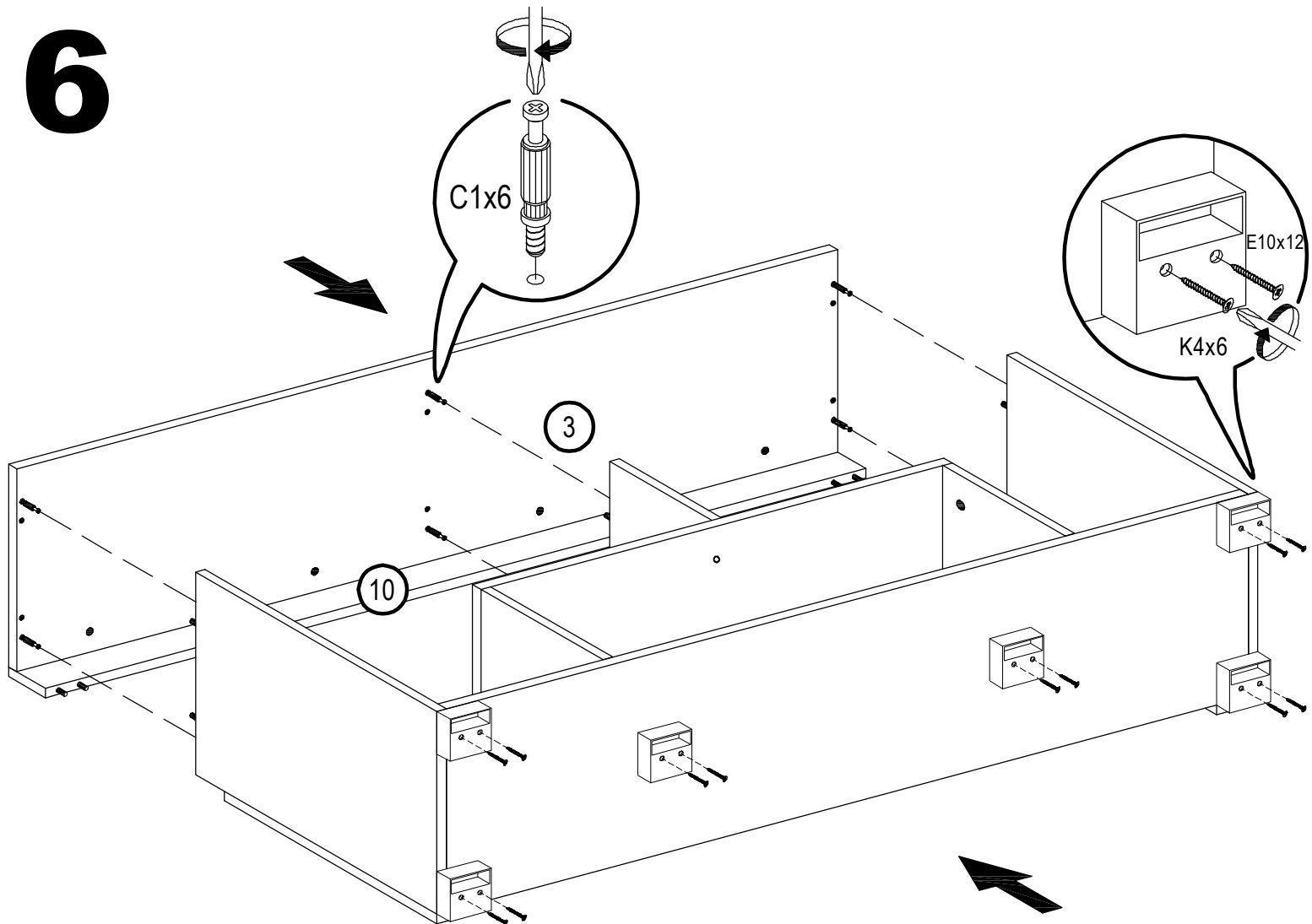
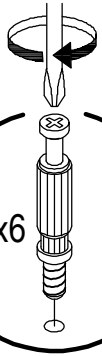

7

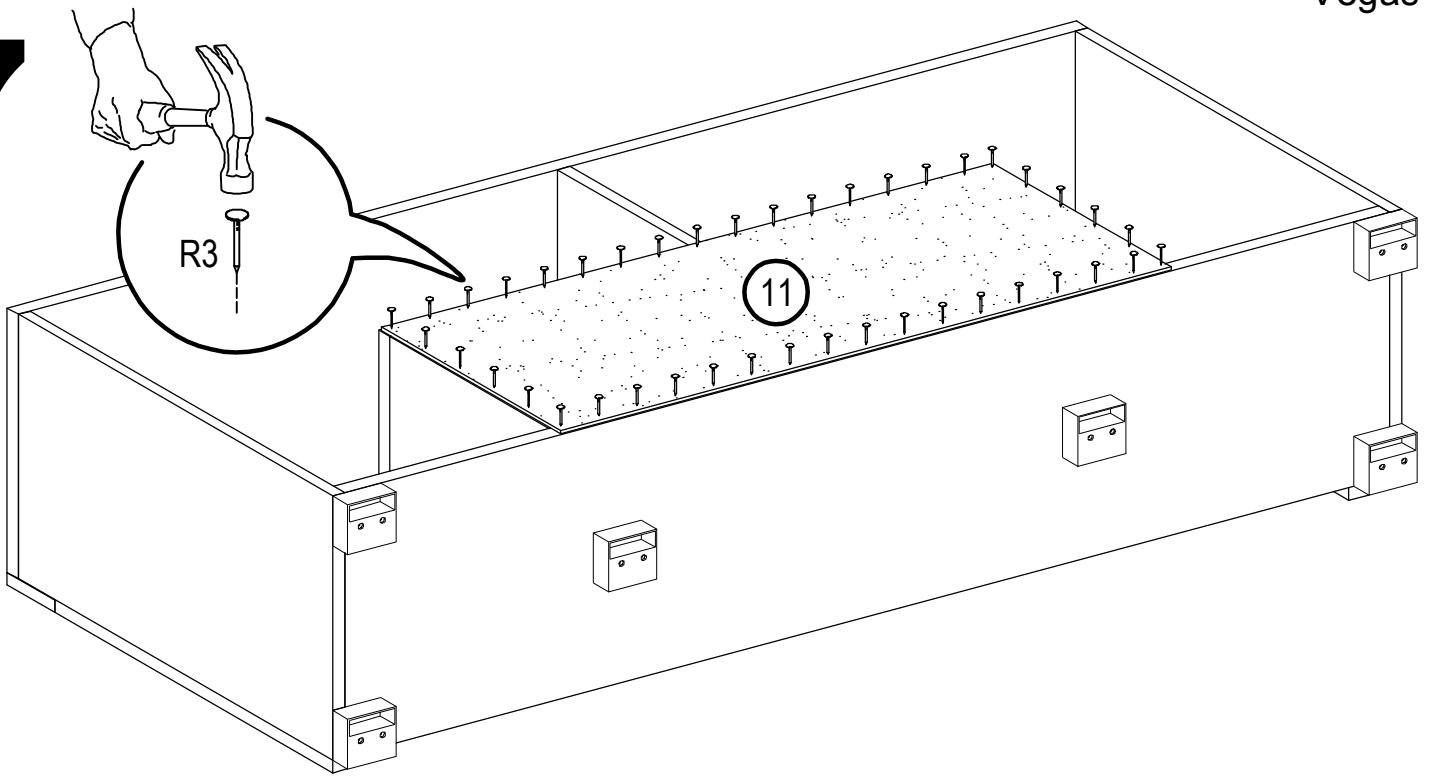

8

